

PLEASE CHECK WWW.MOLEX.COM FOR LATEST PART INFORMATION

Part Number: [0026481236](#)
Status: **Active**
Description: 3.96mm (.156") Pitch KK® Header, Breakaway, Right Angle, with Friction Lock, 23 Circuits, Tin (Sn) Plating

Documents:

3D Model	Product Specification PS-08-50 (PDF)
Packaging Specification (PDF)	RoHS Certificate of Compliance (PDF)
Drawing (PDF)	

Agency Certification

CSA	LR19980
UL	E29179

General

Product Family	PCB Headers
Series	41672
Application	Wire-to-Board
Product Name	KK®

Physical

Breakaway	Yes
Circuits (Loaded)	23
Circuits (maximum)	23
Color - Resin	Black
Durability (mating cycles max)	25
Flammability	94V-0
Glow-Wire Compliant	No
Lock to Mating Part	Yes
Material - Metal	Brass
Material - Plating Mating	Tin
Material - Resin	Polyester
Number of Rows	1
Orientation	Right Angle
PC Tail Length (in)	0.212 In
PC Tail Length (mm)	5.38 mm
PCB Locator	No
PCB Retention	None
PCB Thickness Recommended (in)	0.062 In
PCB Thickness Recommended (mm)	1.60 mm
Packaging Type	Bag
Pitch - Mating Interface (in)	0.156 In
Pitch - Mating Interface (mm)	3.96 mm
Polarized to Mating Part	No
Polarized to PCB	Yes
Shrouded	No
Stackable	No
Temperature Range - Operating	0°C to +75°C
Termination Interface: Style	Through Hole

Electrical

Current - Maximum per Contact	7A
Voltage - Maximum	250V

Solder Process Data

Lead-free Process Capability	Wave Capable (TH only)
------------------------------	------------------------



Series

image - Reference only

EU RoHS

ELV and RoHS Compliant
REACH SVHC
 Not Reviewed
Halogen-Free Status
 Not Reviewed

China RoHS



Need more information on product environmental compliance?

Email productcompliance@molex.com
 For a multiple part number RoHS Certificate of Compliance, [click here](#)

Please visit the [Contact Us](#) section for any non-product compliance questions.

Search Parts in this Series

[41672Series](#)

Mates With

[3069](#) , [3215](#) , [2139](#) , [2145](#) , [6442](#) , [7674](#) , [7675](#) , [41695](#) , [41815](#)

Material Info

Old Part Number

A-41672-A23A102

Reference - Drawing Numbers

Product Specification

PS-08-50

Sales Drawing

SD-41672-001, SD-41672-002

This document was generated on 03/22/2010

PLEASE CHECK WWW.MOLEX.COM FOR LATEST PART INFORMATION

CENTERLINE OF PIN IN AREA SHOWN NOT TO VARY FROM CENTERLINE OF PIN AT -D- BY MORE THAN 0.13/.005 IN ANY DIRECTION.

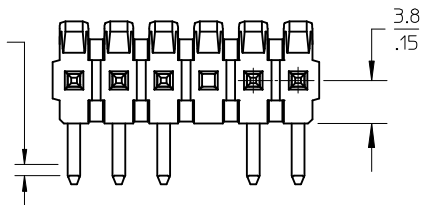

A-41672- * N * * * *
 OPTION - PACKING
 A= 2161 PIN- BULK PACK
 B= 43294 PIN- BULK PACK
 NO OF CKTS
 DIM M.L.P
 PLATING
 VOID LOCATIONS
 BLANK=NO VOIDS
 NO=CKT NO VOIDED
 MULT-VOIDS=51 UP

CIRCUIT	A	B
2	6.78/7.87 .267/1.310	3.96 .156
3	10.74/11.84 .423/1.466	7.92 .312
4	14.71/15.80 .579/1.622	11.89 .468
5	18.67/19.76 .735/1.778	15.85 .624
6	22.63/23.72 .891/1.934	19.81 .780
7	26.59/27.69 1.047/1.090	23.77 .936
8	30.56/31.65 1.203/1.246	27.74 1.092
9	34.52/35.61 1.359/1.402	31.70 1.248
10	38.48/39.57 1.515/1.558	35.66 1.404
11	42.44/43.54 1.671/1.714	39.62 1.560
12	46.41/47.50 1.827/1.870	43.59 1.716
13	50.37/51.46 1.983/2.026	47.55 1.872
14	54.33/55.42 2.139/2.182	51.51 2.028
15	58.29/59.39 2.295/2.338	55.47 2.184
16	62.26/63.35 2.451/2.494	59.44 2.340
17	66.22/67.31 2.607/2.650	63.40 2.496
18	70.18/71.27 2.763/2.806	67.36 2.652
19	74.14/75.23 2.919/2.962	71.32 2.808
20	78.11/79.20 3.075/3.118	75.29 2.964
21	82.07/83.16 3.231/3.274	79.25 3.120
22	86.03/87.12 3.387/3.430	83.21 3.276
23	89.94/91.08 3.541/3.586	87.17 3.432
24	93.85/95.00 3.695/3.740	91.14 3.588

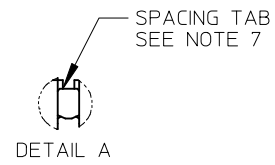
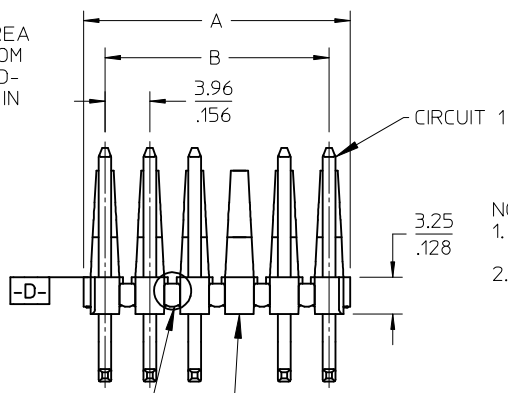
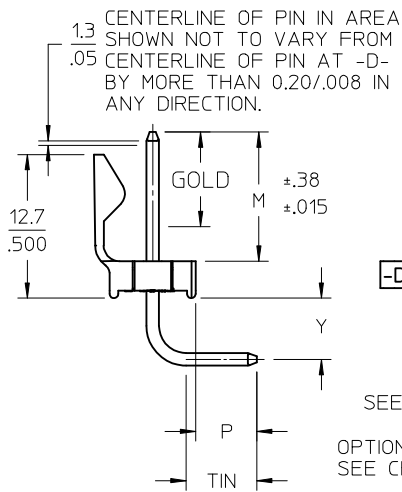

- NOTES:
 1. MATERIAL: HEADER: POLYESTER, 94V-0, MOLDED BLACK PIN: BRASS
 2. FINISH:
 (102) OVERALL TIN: 0.00508/.000200 MIN OVER 0.00254/.000100 MIN COPPER.
 (154) OVERALL TIN: 0.00254/.000100 MIN OVER 0.00127/.000050 MIN NICKEL.
 (208) SELECT GOLD: 0.00038/.000015 MIN, *SELECT TIN: 0.00254/.000100 MIN, OVERALL NICKEL UNDERPLATE: 0.00127/.000050 MIN.
 (228) SELECT GOLD: 0.00076/.000030 MIN, *SELECT TIN: 0.00254/.000100 MIN, OVERALL NICKEL UNDERPLATE: 0.00127/.000050 MIN.
 (501) OVERALL GOLD: 0.00051/.000020 MIN OVER 0.00076/.000030 MIN NICKEL.
 (503) OVERALL GOLD: 0.00076/.000030 MIN OVER 0.00127/.000050 MIN NICKEL.
 *THE PRIMARY SHIPPING CARTON WILL BE LABELED "COMPLIANT TO RoHS DIRECTIVE 2002/95/EC AND ELV ANNEX II OF DIRECTIVE 2000/53/EC". CARTONS WITHOUT THIS LABEL MAY CONTAIN PRODUCT WITH TIN/LEAD PLATINGS.
 3. PRODUCT SPECIFICATION: PS-08-50.
 4. PACKAGING INFORMATION: SEE TABLES
 5. SOLDERABILITY: PER SMES-152.
 6. PIN PUSH-OUT FORCE: PRIOR TO SOLDERING, A 3 LB. MINIMUM FORCE IN EITHER DIRECTION SHALL BE REQUIRED TO PUSH THE PIN OUT OF THE HEADER.
 7. PARTS ARE STACKABLE END TO END ON 3.96/.156 CENTERS.(SPACING TABS MUST BE REMOVED ON CIRCUIT SIZES 1-23 BEFORE PARTS ARE STACKABLE.
 8. PARTS WILL CONFORM TO CLASS B REQUIREMENTS OF COSMETIC SPECIFICATION PS-45499-002.

SEE DETAIL A
 OPTIONAL VOIDED CKT. SEE CHART FOR LOCATIONS

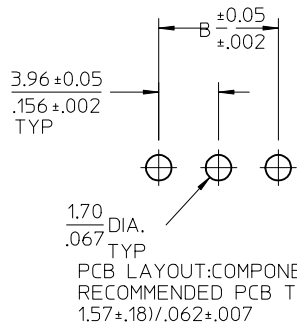

ADD 41672-0228	QUALITY SYMBOLS
EC NO: UCP2009-2938	▼=0
DRWN:MK LIPPER 2009/06/12	▽=0
CHKD:SSOUSEK 2009/06/15	
APPR:FSM TH 2009/06/15	
DESCRIPTION	
REV	
2-* AB4	
1 AB4	
SHEET REV	
AB4	

GENERAL TOLERANCES (UNLESS SPECIFIED)	
mm	INCH
4 PLACES ± ---	± ---
3 PLACES ± ---	± .010
2 PLACES ± 0.25	± .015
1 PLACE ± 0.38	± ---
ANGULAR ±1/2°	
DRAFT WHERE APPLICABLE MUST REMAIN WITHIN DIMENSIONS	

DIMENSION STYLE	
MM/IN	
DRAWN BY	DATE
JSCHAFFER	12-5-03
CHECKED BY	DATE
KSAMIEC	12-12-03
APPROVED BY	DATE
MARGULIS	12-16-03
MATERIAL NO.	
SEE CHART	
SIZE	
A	

SCALE	DESIGN UNITS	THIRD ANGLE PROJECTION
2:1	INCH	☉
TITLE		
KK .156 HEADER ASSEMBLY FRICTION LOCK BREAKAWAY RIGHT ANGLE		
MOLEX MOLEX INCORPORATED		
DOCUMENT NO.	SHEET NO.	
SD-41672-001	1 OF *	
THIS DRAWING CONTAINS INFORMATION THAT IS PROPRIETARY TO MOLEX INCORPORATED AND SHOULD NOT BE USED WITHOUT WRITTEN PERMISSION		

Header No:	41186-A-AN
Pin No:	2161-37(102)
Pin Length L	1.100 / 27.90
Mating M	.450 / 11.43
Gold:	NA
Bend Height: Y	.213 / 5.41
PC Tail P	.212 / 5.38
Tin:	OVERALL
Pack Per	PK-41672-001

Header No:	41186-A-AN
Pin No:	43294-0569
Pin Length L	1.100 / 27.90
Mating M	.450 / 11.43
Gold:	.270 / 6.86
Bend Height: Y	.213 / 5.41
PC Tail P	.212 / 5.38
Tin:	.200 / 5.08
Pack Per	PK-41672-001

Header No:	41186-A-AN
Pin No:	43294-0570
Pin Length L	1.100 / 27.90
Mating M	.450 / 11.43
Gold:	.270 / 6.86
Bend Height: Y	.213 / 5.41
PC Tail P	.212 / 5.38
Tin:	.200 / 5.08
Pack Per	PK-41672-001

Header No:	41186-A-AN
Pin No:	2161-37(501)
Pin Length L	1.100 / 27.90
Mating M	.450 / 11.43
Gold:	OVERALL
Bend Height: Y	.213 / 5.41
PC Tail P	.212 / 5.38
Tin:	NA
Pack Per	PK-41672-001

Ckts	Material No	Engineer Number
2	026481026	A-41672-A02A102
3	026481036	A-41672-A03A102
4	026481046	A-41672-A04A102
5	026481056	A-41672-A05A102
6	026481066	A-41672-A06A102
7	026481076	A-41672-A07A102
8	026481086	A-41672-A08A102
9	026481096	A-41672-A09A102
10	026481106	A-41672-A10A102
11	026481116	A-41672-A11A102
12	026481126	A-41672-A12A102
13	026481136	A-41672-A13A102
14	026481146	A-41672-A14A102
15	026481156	A-41672-A15A102
16	026481166	A-41672-A16A102
17	026481176	A-41672-A17A102
18	026481186	A-41672-A18A102
19	026481196	A-41672-A19A102
20	026481206	A-41672-A20A102
21	026481216	A-41672-A21A102
22	026481226	A-41672-A22A102
23	026481236	A-41672-A23A102
24	026481246	A-41672-A24A102

Material No	Engineer Number
41672-0001	A-41672-B02A208
41672-0002	A-41672-B03A208
41672-0003	A-41672-B04A208
41672-0004	A-41672-B05A208
41672-0005	A-41672-B06A208
41672-0006	A-41672-B07A208
41672-0007	A-41672-B08A208
41672-0008	A-41672-B09A208
41672-0009	A-41672-B10A208
41672-0010	A-41672-B11A208
41672-0011	A-41672-B12A208
41672-0012	A-41672-B13A208
41672-0013	A-41672-B14A208
41672-0014	A-41672-B15A208
41672-0015	A-41672-B16A208
41672-0016	A-41672-B17A208
41672-0017	A-41672-B18A208
41672-0018	A-41672-B19A208
41672-0019	A-41672-B20A208
41672-0020	A-41672-B21A208
41672-0021	A-41672-B22A208
41672-0022	A-41672-B23A208
41672-0023	A-41672-B24A208

Material No	Engineer Number
41672-0024	A-41672-B02A228
41672-0025	A-41672-B03A228
41672-0026	A-41672-B04A228
41672-0027	A-41672-B05A228
41672-0028	A-41672-B06A228
41672-0029	A-41672-B07A228
41672-0030	A-41672-B08A228
41672-0031	A-41672-B09A228
41672-0032	A-41672-B10A228
41672-0033	A-41672-B11A228
41672-0034	A-41672-B12A228
41672-0035	A-41672-B13A228
41672-0036	A-41672-B14A228
41672-0037	A-41672-B15A228
41672-0038	A-41672-B16A228
41672-0039	A-41672-B17A228
41672-0040	A-41672-B18A228
41672-0041	A-41672-B19A228
41672-0042	A-41672-B20A228
41672-0043	A-41672-B21A228
41672-0044	A-41672-B22A228
41672-0045	A-41672-B23A228
41672-0046	A-41672-B24A228

Material No	Engineer Number
026482026	A-41672-A02A501
026482036	A-41672-A03A501
026482046	A-41672-A04A501
026482056	A-41672-A05A501
026482066	A-41672-A06A501
026482076	A-41672-A07A501
026482086	A-41672-A08A501
026482096	A-41672-A09A501
026482106	A-41672-A10A501
026482116	A-41672-A11A501
026482126	A-41672-A12A501
026482136	A-41672-A13A501
026482146	A-41672-A14A501
026482156	A-41672-A15A501
026482166	A-41672-A16A501
026482176	A-41672-A17A501
026482186	A-41672-A18A501
026482196	A-41672-A19A501
026482206	A-41672-A20A501
026482216	A-41672-A21A501
026482226	A-41672-A22A501
026482236	A-41672-A23A501
026482246	A-41672-A24A501

AB4	REV:	<u>ECR/ECN INFORMATION:</u>	<u>TITLE:</u>	KK 156 HEADER ASSEMBLY FRICTION LOCK BREAKAWAY RIGHT ANGLE	<u>SHEET No.</u>
		EC No.: UCP2009-2938			- 2 -
		DATE: 6/15/2009			
<u>DOCUMENT NUMBER:</u>		<u>CREATED / REVISED BY:</u>	<u>CHECKED BY:</u>	<u>APPROVED BY:</u>	
SD- 41672 -001		MKIPPER	SSOUSEK	FSMITH	

Header No:	41186-A-AN
Pin No:	2161-96(501)
Pin Length L	1.531 / 38.89
Mating M	.500 / 12.70
Gold:	OVERALL
Bend Height: Y	.213 / 5.41
PC Tail P	.592 / 15.04
Tin:	NA
Pack Per	PK-41672-001

Header No:	41186-A-AN
Pin No:	2161-37(501)
Pin Length L	1.100 / 27.90
Mating M	.523 / 13.28
Gold:	OVERALL
Bend Height: Y	.213 / 5.41
PC Tail P	.136 / 3.45
Tin:	NA
Pack Per	PK-41672-001

Header No:	41186-A-AN
Pin No:	2161-19(102)
Pin Length L	1.032 / 26.21
Mating M	.458/11.63 REF
Gold:	NA
Bend Height: Y	.221 / 5.61
PC Tail P	.125+- .015
Tin:	OVERALL
Pack Per	PK-41672-001

Header No:	41186-A-AN
Pin No:	2161-19(102)
Pin Length L	1.032 / 26.21
Mating M	.461 / 11.71
Gold:	NA
Bend Height: Y	.213 / 5.41
PC Tail P	.130 / 3.30
Tin:	OVERALL
Pack Per	PK-41672-001

Ckts	Material No	Engineer Number	Material No	Engineer Number	Material No	Engineer Number	Material No	Engineer Number
2	41672-0109	A-41672-A02D501	026586020	A-41672-A02C501	026482029	A-41672-A02E102	41672-0151	A-41672-A02F102
3	41672-0110	A-41672-A03D501	026586030	A-41672-A03C501	026482039	A-41672-A03E102	41672-0152	A-41672-A03F102
4	41672-0111	A-41672-A04D501	41672-0131	A-41672-A04C501	026482049	A-41672-A04E102	41672-0153	A-41672-A04F102
5	41672-0112	A-41672-A05D501	41672-0132	A-41672-A05C501	026482059	A-41672-A05E102	41672-0154	A-41672-A05F102
6	41672-0113	A-41672-A06D501	41672-0133	A-41672-A06C501	026482069	A-41672-A06E102	41672-0155	A-41672-A06F102
7	41672-0114	A-41672-A07D501	41672-0134	A-41672-A07C501	026482079	A-41672-A07E102	41672-0156	A-41672-A07F102
8	41672-0115	A-41672-A08D501	026586080	A-41672-A08C501	026482089	A-41672-A08E102	41672-0157	A-41672-A08F102
9	41672-0116	A-41672-A09D501	41672-0135	A-41672-A09C501	026482099	A-41672-A09E102	41672-0158	A-41672-A09F102
10	41672-0117	A-41672-A10D501	41672-0136	A-41672-A10C501	026482109	A-41672-A10E102	41672-0159	A-41672-A10F102
11	41672-0118	A-41672-A11D501	41672-0137	A-41672-A11C501	026482119	A-41672-A11E102	41672-0160	A-41672-A11F102
12	41672-0119	A-41672-A12D501	41672-0138	A-41672-A12C501	026482129	A-41672-A12E102	41672-0161	A-41672-A12F102
13	41672-0120	A-41672-A13D501	41672-0139	A-41672-A13C501	026482139	A-41672-A13E102	41672-0162	A-41672-A13F102
14	41672-0121	A-41672-A14D501	41672-0140	A-41672-A14C501	026482149	A-41672-A14E102	41672-0163	A-41672-A14F102
15	41672-0122	A-41672-A15D501	41672-0141	A-41672-A15C501	026482159	A-41672-A15E102	41672-0164	A-41672-A15F102
16	41672-0123	A-41672-A16D501	41672-0142	A-41672-A16C501	026482169	A-41672-A16E102	41672-0165	A-41672-A16F102
17	41672-0124	A-41672-A17D501	41672-0143	A-41672-A17C501	026482179	A-41672-A17E102	41672-0166	A-41672-A17F102
18	41672-0125	A-41672-A18D501	41672-0144	A-41672-A18C501	026482189	A-41672-A18E102	41672-0167	A-41672-A18F102
19	41672-0126	A-41672-A19D501	41672-0145	A-41672-A19C501	026482199	A-41672-A19E102	41672-0168	A-41672-A19F102
20	41672-0127	A-41672-A20D501	41672-0146	A-41672-A20C501	026482209	A-41672-A20E102	41672-0169	A-41672-A20F102
21	41672-0128	A-41672-A21D501	41672-0147	A-41672-A21C501	026482219	A-41672-A21E102	41672-0170	A-41672-A21F102
22	41672-0129	A-41672-A22D501	41672-0148	A-41672-A22C501	026482229	A-41672-A22E102	41672-0171	A-41672-A22F102
23	41672-0130	A-41672-A23D501	41672-0149	A-41672-A23C501	026482239	A-41672-A23E102	41672-0172	A-41672-A23F102
24	026586242	A-41672-A24D501	41672-0150	A-41672-A24C501	026482249	A-41672-A24E102	41672-0173	A-41672-A24F102

REV: AB4	<u>ECR/ECN INFORMATION:</u>	<u>TITLE:</u> KK 156 HEADER ASSEMBLY FRICTION LOCK BREAKAWAY RIGHT ANGLE	<u>SHEET No.</u>	
	<u>EC No.:</u> UCP2009-2938		- 4 -	
	<u>DATE:</u> 6/15/2009			
<u>DOCUMENT NUMBER:</u> SD- 41672 -001		<u>CREATED / REVISED BY:</u> MKIPPER	<u>CHECKED BY:</u> SSOUSEK	<u>APPROVED BY:</u> FSMITH

Header No:	41186-A-AN
Pin No:	2161-52(102)
Pin Length L	1.063 / 27.00
Mating M	.450 / 11.43
Gold:	NA
Bend Height: Y	.213 / 5.41
PC Tail P	.172 / 4.69
Tin:	OVERALL
Pack Per	PK-41672-001

Header No:	41186-A-AN
Pin No:	2161-37(102)
Pin Length L	1.100 / 27.90
Mating M	.450 / 11.43
Gold:	NA
Bend Height: Y	.213 / 5.41
PC Tail P	.212 / 5.38
Tin:	OVERALL
Pack Per	PK-41672-001

Header No:	41186-A-AN
Pin No:	2161-37(501)
Pin Length L	1.100 / 27.90
Mating M	.450 / 11.43
Gold:	OVERALL
Bend Height: Y	.213 / 5.41
PC Tail P	.212 / 5.38
Tin:	NA
Pack Per	PK-41672-001

Ckts	Material No	Engineer Number
2	41672-0176	A-41672-A02G102
3	41672-0177	A-41672-A03G102
4	41672-0178	A-41672-A04G102
5	41672-0179	A-41672-A05G102
6	41672-0180	A-41672-A06G102
7	41672-0181	A-41672-A07G102
8	41672-0182	A-41672-A08G102
9	41672-0183	A-41672-A09G102
10	41672-0184	A-41672-A10G102
11	41672-0185	A-41672-A11G102
12	41672-0186	A-41672-A12G102
13	41672-0187	A-41672-A13G102
14	41672-0188	A-41672-A14G102
15	41672-0189	A-41672-A15G102
16	41672-0190	A-41672-A16G102
17	41672-0191	A-41672-A17G102
18	41672-0192	A-41672-A18G102
19	41672-0193	A-41672-A19G102
20	41672-0194	A-41672-A20G102
21	41672-0195	A-41672-A21G102
22	41672-0196	A-41672-A22G102
23	41672-0197	A-41672-A23G102
24	41672-0198	A-41672-A24G102

Material No	Engineer Number	Void
026504051	A-41672-A05A102-51	2,4
41672-0047	A-41672-A02A102-1	1
41672-0174	A-41672-A23A102-51	18,20 .22
026504042	A-41672-A04A102-02	2
026504061	A-41672-A06A102-4	4
026504043	A-41672-A04A102-3	3
026504062	A-41672-A06A102-5	5
416720048	A-41672-A09A102-51	2,3,4, 6,7,8
416720049	A-41672-A14A102-12	12
026504102	A-41672-A10A102-5	5
026504072	A-41672-A07A102-2	2
41672-0175	A-41672-A11A102-2	2
41672-0203	A-41672-A14A102-51	2,6, 11,13
41672-0227	A-41672-A05A102-2	2

Material No	Engineer Number	Void
026504121	A-41672-A12A501-51	4,6
026497063	A-41672-A06A501-5	5

REV: AB4	<u>ECR/ECN INFORMATION:</u>	<u>TITLE:</u> KK 156 HEADER ASSEMBLY FRICTION LOCK BREAKAWAY RIGHT ANGLE	<u>SHEET No.</u>	
	<u>EC No.:</u> UCP2009-2938		- 5 -	
	<u>DATE:</u> 6/15/2009			
<u>DOCUMENT NUMBER:</u> SD- 41672 -001		<u>CREATED / REVISED BY:</u> MKIPPER	<u>CHECKED BY:</u> SSOUSEK	<u>APPROVED BY:</u> FSMITH

Header No:	41186-A-AN		Header No:	41186-A-AN		Header No:	41186-A-AN	
Pin No:	2161-19(102)		Pin No:	2161-52(102)		Pin No:	2161-19(154)	
Pin Length L	1.032 / 26.21		Pin Length L	1.063 / 27.00		Pin Length L	1.032 / 26.21	
Mating M	.461 / 11.71		Mating M	.450 / 11.43		Mating M	.458 / 11.63	
Gold:	NA		Gold:	NA		Gold:	NA	
Bend Height: Y	.213 / 5.41		Bend Height: Y	.213 / 5.41		Bend Height: Y	.221 / 5.61	
PC Tail P	.130 / 3.30		PC Tail P	.172 / 4.69		PC Tail P	.125 / 3.18	
Tin:	OVERALL		Tin:	OVERALL		Tin:	OVERALL	
Pack Per	PK-41672-001		Pack Per	PK-41672-001		Pack Per	PK-41672-001	
Material No	Engineer Number	Void	Material No	Engineer Number	Void	Material No	Engineer Number	Void
026504044	A-41672-A04F102-3	3	41672-0199	A-41672-A03G102-1	1	41672-0228	A-41672-A05E154-2	2
			41672-0200	A-41672-A05G102-4	4			
			41672-0201	A-41672-A03G102-3	3			
			41672-0202	A-41672-A05G102-3	3			

REV:	<u>ECR/ECN INFORMATION:</u>	<u>TITLE:</u>	<u>SHEET No.</u>
AB4	EC No.: UCP2009-2938	KK 156 HEADER ASSEMBLY FRICTION LOCK BREAKAWAY RIGHT ANGLE	- 7 -
	DATE: 6/15/2009		
<u>DOCUMENT NUMBER:</u>	<u>CREATED / REVISED BY:</u>	<u>CHECKED BY:</u>	<u>APPROVED BY:</u>
SD- 41672 -001	MKIPPER	SSOUSEK	FSMITH

6

5

4

3

2

1

CENTERLINE OF PIN IN AREA SHOWN NOT TO VARY FROM CENTERLINE OF PIN AT -D- BY MORE THAN 0.13/.005 IN ANY DIRECTION.

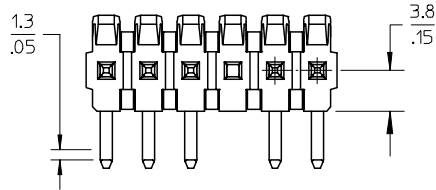

A-41681- * N * * * *
 OPTION - PACKING
 A=BRASS - BULK PACK
 B=BRASS - TUBE PACK
 NO OF CKTS
 DIM M.L.P
 PLATING
 VOID LOCATIONS
 BLANK=NO VOIDS
 NO=CKT NO VOIDED
 MULT-VOIDS=51 UP

CENTERLINE OF PIN IN AREA SHOWN NOT TO VARY FROM CENTERLINE OF PIN AT -D- BY MORE THAN 0.20/.008 IN ANY DIRECTION.

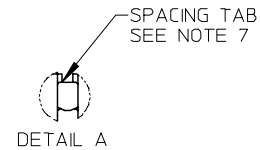

OPTIONAL VOIDED CKT. SEE CHART FOR LOCATIONS

NOTES:

- MATERIAL: HEADER: POLYESTER, 94V-0, MOLDED BLACK
- FINISH:
 (228) SELECT GOLD: 0.00076/.000030 MIN.
 *SELECT TIN: 0.00254/.000100 MIN.
 OVERALL NICKEL UNDERPLATE: 0.00127/.000050 MIN.
 *THE PRIMARY SHIPPING CARTON WILL BE LABELED "COMPLIANT TO ROHS DIRECTIVE 2002/95/EC AND ELV ANNEX II OF DIRECTIVE 2000/53/EC". CARTONS WITHOUT THIS LABEL MAY CONTAIN PRODUCT WITH TIN/LEAD PLATINGS.
- PRODUCT SPECIFICATION: PS-08-50.
- PACKAGING INFORMATION: SEE CHARTS
- SOLDERABILITY: PER SMES-152.
- PIN PUSH-OUT FORCE: PRIOR TO SOLDERING, A 3 LB. MINIMUM FORCE IN EITHER DIRECTION SHALL BE REQUIRED TO PUSH THE PIN OUT OF THE HEADER.
- PARTS ARE STACKABLE END TO END ON 3.96/.156 CENTERS.(SPACING TABS MUST BE REMOVED ON CIRCUIT SIZES 1-23 BEFORE PARTS ARE STACKABLE.

CIRCUIT	A	B
2	6.78/7.87 .267/.310	3.96 .156
3	10.74/11.84 .423/.466	7.92 .312
4	14.71/15.80 .579/.622	11.89 .468
5	18.67/19.76 .735/.778	15.85 .624
6	22.63/23.72 .891/.934	19.81 .780
7	26.59/27.69 1.047/1.090	23.77 .936
8	30.56/31.65 1.203/1.246	27.74 1.092
9	34.52/35.61 1.359/1.402	31.70 1.248
10	38.48/39.57 1.515/1.558	35.66 1.404
11	42.44/43.54 1.671/1.714	39.62 1.560
12	46.41/47.50 1.827/1.870	43.59 1.716
13	50.37/51.46 1.983/2.026	47.55 1.872
14	54.33/55.42 2.139/2.182	51.51 2.028
15	58.29/59.39 2.295/2.338	55.47 2.184
16	62.26/63.35 2.451/2.494	59.44 2.340
17	66.22/67.31 2.607/2.650	63.40 2.496
18	70.18/71.27 2.763/2.806	67.36 2.652
19	74.14/75.23 2.919/2.962	71.32 2.808
20	78.11/79.20 3.075/3.118	75.29 2.964
21	82.07/83.16 3.231/3.274	79.25 3.120
22	86.03/87.12 3.387/3.430	83.21 3.276
23	89.94/91.08 3.541/3.586	87.17 3.432
24	93.85/95.00 3.695/3.740	91.14 3.588

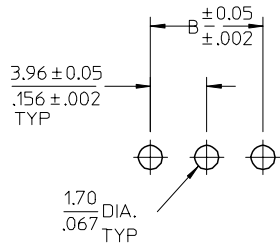

PCB LAYOUT:COMPONENT SIDE
 RECOMMENDED PCB THICKNESS:
 (1.57±.18)/.062±.007

ADD DIMENSION	EC NO: UCP2006-2296	DRWN:PR IDDER	CHKD:ADERR	APPR:FSMITH
	2006/04/27	2006/04/28	2006/04/28	2006/04/28
DESCRIPTION				
REV				

QUALITY SYMBOLS	DESCRIPTION
▽=0	
▽=0	

GENERAL TOLERANCES (UNLESS SPECIFIED)	mm	INCH
	4 PLACES ± ---	± ---
	3 PLACES ± ---	± .010
	2 PLACES ± 0.25	± .015
	1 PLACE ± 0.38	± ---
	ANGULAR ± 1/2°	
DRAFT WHERE APPLICABLE MUST REMAIN WITHIN DIMENSIONS		

DIMENSION STYLE MM/IN	
DRAWN BY JSCHAFFER	DATE 12-5-03
CHECKED BY KSAMIEC	DATE 12-12-03
APPROVED BY MARGULIS	DATE 12-16-03
MATERIAL NO. SEE CHART	
SIZE A	THIS DRAWING CONTAINS INFORMATION THAT IS PROPRIETARY TO MOLEX INCORPORATED AND SHOULD NOT BE USED WITHOUT WRITTEN PERMISSION

SCALE 2:1	DESIGN UNITS INCH	THIRD ANGLE PROJECTION
TITLE KK .156 HEADER ASSEMBLY FRICTION LOCK BREAKAWAY RIGHT ANGLE (LEAD-FREE)		
MOLEX MOLEX INCORPORATED		
MATERIAL NO. SD-41672-002	DOCUMENT NO.	SHEET NO. 1 OF *

5

4

3

2

1

Header No:	41186-A-AN
Pin No:	43294-0570
Pin Length L:	1.100 / 27.90
Mating M:	.450 / 11.43
Gold:	.270 / 6.86
Bend Height: Y:	.213 / 5.41
PC Tail P:	.212 / 5.38
Tin:	.200 / 5.08
Pack Per:	PK-41672-001

Header No:	
Pin No:	
Pin Length L:	
Mating M:	
Gold:	
Bend Height: Y:	
PC Tail P:	
Tin:	
Pack Per:	

Header No:	
Pin No:	
Pin Length L:	
Mating M:	
Gold:	
Bend Height: Y:	
PC Tail P:	
Tin:	
Pack Per:	

Header No:	
Pin No:	
Pin Length L:	
Mating M:	
Gold:	
Bend Height: Y:	
PC Tail P:	
Tin:	
Pack Per:	

Ckts	Material No	Engineer Number	Material No	Engineer Number	Material No	Engineer Number	Material No	Engineer Number
2								
3								
4								
5								
6	50-29-1898	A-41672-B06A228						
7								
8								
9								
10								
11								
12								
13								
14								
15								
16								
17								
18								
19								
20								
21								
22								
23								
24								

A1	REV:	ECR/ECN INFORMATION:	TITLE:	SHEET No.
		EC No.: UCP2006-1776	KK 156 HEADER ASSEMBLY FRICTION LOCK BREAKAWAY RIGHT ANGLE (LEAD-FREE)	- 2 -
		DATE: 4/11/2006		
DOCUMENT NUMBER: SD- 41672 -002		CREATED / REVISED BY: ADERR	CHECKED BY: SSOUSEK	APPROVED BY: FSMITH