

ASQ48T15033 & ASQ48S15033 DC-DC Converter Data Sheet

36 to 75 VDC Input; 15A, 3.3 VDC Output



Description

The **ASQ48 Series** DC-DC converters are ideally suited for aerospace applications where high-reliability, low profile, and low weight are critical. They are designed for reliable operation in harsh thermal and mechanical environments.

In high-ambient temperature applications the **ASQ48 Series** 15A converters provide thermal performance that exceeds most competing DC-DC converters that have a higher nominal rating and much larger package size. This is accomplished using patent pending circuit, packaging, and processing techniques to achieve ultra-high efficiency, excellent thermal management and a very low body profile. Coupled with Power-One's use of 100% automation for assembly; this results in a product with extremely high quality and reliability.

Available in both through-hole and surface mount packages, the **ASQ48 Series** converters are also ideal for environments with little or no airflow.

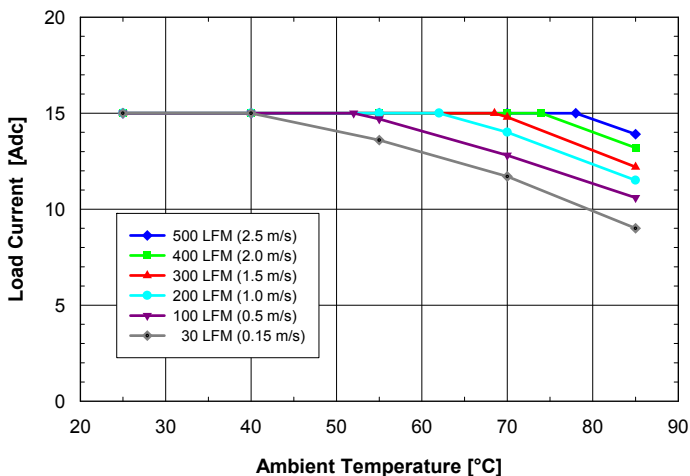
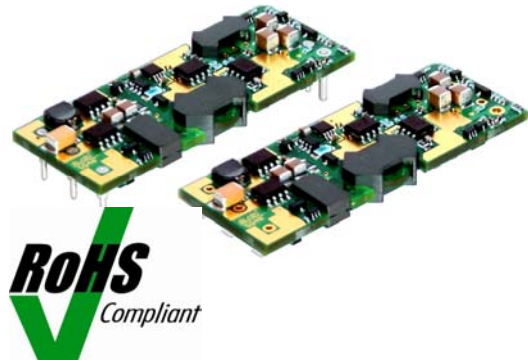

Fig. 1: Available load current vs. ambient air temperature and air-flow rates for ASQ48T15033 converter with D height pins mounted vertically with air flowing from pin 3 to pin 1, MOSFET temperature ≤ 120 °C, $V_{in} = 48$ V.



ASQ48T15033 and ASQ48S15033 Converters

Features

- RoHS lead solder exemption compliant
- Delivers up to 15 A (50 W)
- Operates from - 55 °C to 85 °C ambient
- Survives 1000 g mechanical shock, MIL-STD-883E
- High reliability: MTBF 3.4 million hours, calculated per Telcordia TR-332, Method I Case 1
- Available in through-hole and SM packages
- Low weight: 0.53 oz (15 g)
- Low profile: 0.26" (6.6 mm)
- Extremely small footprint: 0.896" x 2.30" (2.06 in²)
- High efficiency – no heat sink required
- On-board input differential LC-filter
- Extremely low output and input ripple
- Start-up into pre-biased output
- No minimum load required
- 2,000 VDC I/O Isolation
- Meets Basic Insulation requirements of EN60950
- Meets input voltage transient of 100 V for 100 ms
- Does not use opto-isolators
- Fixed-frequency operation
- Fully protected
- Remote output sense
- Output voltage trim range: +10%/-20%
- Positive or negative logic ON/OFF option
- UL 60950 recognized in U.S. & Canada, and TUV certified per IEC/EN 60950
- Meets conducted emissions requirements of FCC Class B and EN55022 Class B with external filter
- All materials meet UL94, V-0 flammability rating

ASQ48T15033 & ASQ48S15033 DC-DC Converter Data Sheet

36 to 75 VDC Input; 15A, 3.3 VDC Output



Electrical Specifications

Conditions: $T_A=25\text{ }^\circ\text{C}$, Airflow = 300 LFM (1.5 m/s), $V_{in} = 48\text{ VDC}$, unless otherwise specified.

| PARAMETER | NOTES | MIN | TYP | MAX | UNITS |
|--|--------------------------------------|------|-----|--------|------------------|
| ABSOLUTE MAXIMUM RATINGS | | | | | |
| Input Voltage | Continuous | 0 | | 80 | VDC |
| Operating Ambient Temperature | | -55 | | 85 | $^\circ\text{C}$ |
| Storage Temperature | | -55 | | 125 | $^\circ\text{C}$ |
| INPUT CHARACTERISTICS | | | | | |
| Operating Input Voltage Range | | 36 | 48 | 75 | VDC |
| Input Under Voltage Lockout | Non-latching | | | | |
| Turn-on Threshold | | 33 | 34 | 35 | VDC |
| Turn-off Threshold | | 31 | 32 | 33 | VDC |
| Input Voltage Transient | 100 ms | | | 100 | VDC |
| OUTPUT CHARACTERISTICS | | | | | |
| External Load Capacitance | Plus full load (resistive) | | | 15,000 | μF |
| Output Current Range | | 0 | | 15 | ADC |
| Current Limit Inception | Non-latching | 16.5 | 18 | 20 | ADC |
| Peak Short-Circuit Current | Non-latching. Short=10m Ω . | 16.5 | 30 | 40 | A |
| RMS Short-Circuit Current | Non-latching | | | 5.3 | Arms |
| ISOLATION CHARACTERISTICS | | | | | |
| I/O Isolation | | 2000 | | | VDC |
| Isolation Capacitance | | | 160 | | μF |
| Isolation Resistance | | 10 | | | M Ω |
| FEATURE CHARACTERISTICS | | | | | |
| Switching Frequency | | | 415 | | kHz |
| Output Voltage Trim Range ¹ | Use trim equations on Page 7 | -20 | | +10 | % |
| Remote Sense Compensation ¹ | Percent of $V_{OUT(NOM)}$ | | | +10 | % |
| Output Over-Voltage Protection | Non-latching | 117 | 122 | 127 | % |
| Over-Temperature Shutdown (PCB) | Non-latching | | 125 | | $^\circ\text{C}$ |
| Auto-Restart Period | Applies to all protection features | | 100 | | ms |
| Turn-On Time | From ENABLE to 95% of $V_{OUT(NOM)}$ | | 4 | | ms |
| ON/OFF Control (Positive Logic) | | | | | |
| Converter Off | | -20 | | 0.8 | VDC |
| Converter On | | 2.4 | | 20 | VDC |
| ON/OFF Control (Negative Logic) | | | | | |
| Converter Off | | 2.4 | | 20 | VDC |
| Converter On | | -20 | | 0.8 | VDC |

Additional Notes:

- V_{out} can be increased up to 10% via the sense leads or up to 10% via the trim function, however total output voltage trim from all sources should not exceed 10% of $V_{OUT(NOM)}$, in order to insure specified operation of over-voltage protection circuitry. See further discussion at end of **Output Voltage Adjust /TRIM** section.

ASQ48T15033 & ASQ48S15033 DC-DC Converter Data Sheet

36 to 75 VDC Input; 15A, 3.3 VDC Output



Electrical Specifications (continued)

Conditions: $T_A=25\text{ }^\circ\text{C}$, Airflow = 300 LFM (1.5 m/s), $V_{in} = 48\text{ VDC}$, unless otherwise specified.

| PARAMETER | NOTES | MIN | TYP | MAX | UNITS |
|--|---|-------|---------|---------|----------------------------|
| INPUT CHARACTERISTICS | | | | | |
| Maximum Input Current | 15 ADC, 3.3 VDC Out @ 36 VDC In | | | 1.6 | ADC |
| Input Stand-by Current | $V_{in} = 48\text{ V}$, converter disabled | | 3 | | mADC |
| Input No Load Current (0 load on the output) | $V_{in} = 48\text{ V}$, converter enabled | | 45 | | mADC |
| Input Reflected-Ripple Current | See Figure 24 - 25MHz bandwidth | | 7.5 | | $\text{mA}_{\text{PK-PK}}$ |
| Input Voltage Ripple Rejection | 120Hz | | TBD | | dB |
| OUTPUT CHARACTERISTICS | | | | | |
| Output Voltage Set Point (no load) | | 3.267 | 3.300 | 3.333 | VDC |
| Output Regulation | | | | | |
| Over Line | | | ± 2 | ± 5 | mV |
| Over Load | | | ± 2 | ± 5 | mV |
| Output Voltage Range | Over line, load and temperature ² | 3.250 | | 3.350 | VDC |
| Output Ripple and Noise - 25MHz bandwidth | Full load + 10 μF tantalum + 1 μF ceramic | | 30 | 50 | $\text{mV}_{\text{PK-PK}}$ |
| DYNAMIC RESPONSE | | | | | |
| Load Change 25% of $I_{\text{out Max}}$, $di/dt = 0.1\text{ A}/\mu\text{S}$ | $C_o = 1\text{ }\mu\text{F}$ ceramic (Fig.19) | | 90 | | mV |
| $di/dt = 5\text{ A}/\mu\text{S}$ | $C_o = 450\text{ }\mu\text{F}$ tant. + 1 μF ceramic (Fig.20) | | 100 | | mV |
| Setting Time to 1% | | | 100 | | μs |
| EFFICIENCY | | | | | |
| 100% Load | | | 88.5 | | % |
| 50% Load | | | 89 | | % |

Additional Notes:

- 55 $^\circ\text{C}$ to 85 $^\circ\text{C}$

ASQ48T15033 & ASQ48S15033 DC-DC Converter Data Sheet

36 to 75 VDC Input; 15A, 3.3 VDC Output



Physical Information (Through-Hole)

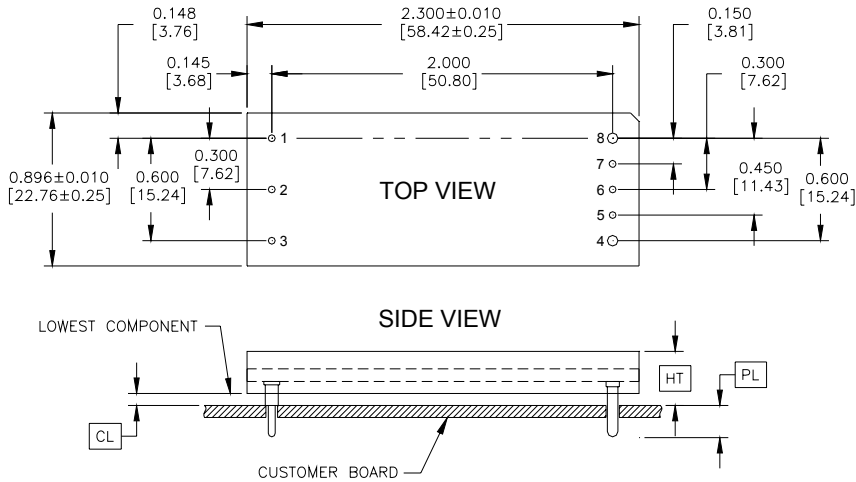

| Connections | |
|-------------|----------|
| Pin # | Function |
| 1 | Vin (+) |
| 2 | ON/OFF |
| 3 | Vin (-) |
| 4 | Vout (-) |
| 5 | SENSE(-) |
| 6 | TRIM |
| 7 | SENSE(+) |
| 8 | Vout (+) |

- All dimensions are in inches [mm]
- Pins 1-3 and 5-3.5 Are \varnothing 0.040" [1.02] with \varnothing 0.078" [1.98] shoulder
- Pins 4 and 8 are \varnothing 0.062" [1.57] without shoulder
- Pin Material: Brass
- Pin Finish: Tin/Lead over Nickel
- Converter Weight: 0.53 oz [15 g]

| Height Option | HT (Maximum Height) | CL (Minimum Clearance) |
|---------------|----------------------------------|----------------------------------|
| | +0.000 [+0.00] -0.038 [-0.97] | +0.016 [+0.41] -0.000 [-0.00] |
| A | 0.303 [7.69] | 0.030 [0.77] |
| B | 0.336 [8.53] | 0.063 [1.60] |
| C | 0.500 [12.70] | 0.227 [5.77] |
| D | 0.400 [10.16] | 0.127 [3.23] |
| E | 0.282 [7.16] | 0.009 [0.23] |

| Pin Option | PL (Pin Length) |
|------------|----------------------------|
| | ± 0.005 [± 0.13] |
| A | 0.188 [4.77] |
| B | 0.145 [3.68] |
| C | 0.110 [2.79] |

Converter Part Numbering Scheme

| Product Series | Input Voltage | Mounting Scheme | Rated Load Current | Output Voltage | ON/OFF Logic | Maximum Height (HT) | Pin Length (PL) | Special Features | |
|-------------------------|---------------|-----------------|--------------------|-------------------------|--|--|--|---------------------|---|
| ASQ | 48 | T | 15 | 033 | - | N | B | A | 0 |
| One-Eighth Brick Format | 36-75 V | Through-hole | 15 ADC | 033 \Rightarrow 3.3 V | N \Rightarrow Negative P \Rightarrow Positive | A \Rightarrow 0.303" B \Rightarrow 0.336" C \Rightarrow 0.500" D \Rightarrow 0.400" E \Rightarrow 0.282" | A \Rightarrow 0.188" B \Rightarrow 0.145" C \Rightarrow 0.110" | 0 \Rightarrow STD | |

The example above describes P/N ASQ48T15033-NBA0: 36-75 V input, through-hole mounting, 15 A @ 3.3 V output, negative ON/OFF logic, a maximum height of 0.336", and a through the board pin length of 188". Please consult factory regarding availability of a specific version.

ASQ48T15033 & ASQ48S15033 DC-DC Converter Data Sheet

36 to 75 VDC Input; 15A, 3.3 VDC Output



Physical Information (Surface Mount)

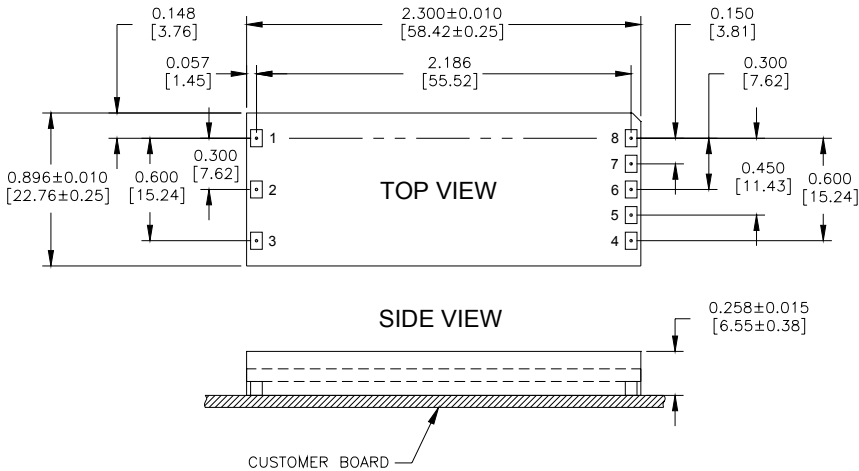

| Pin Connections | |
|-----------------|----------|
| Pin # | Function |
| 1 | Vin (+) |
| 2 | ON/OFF |
| 3 | Vin (-) |
| 4 | Vout (-) |
| 5 | SENSE(-) |
| 6 | TRIM |
| 7 | SENSE(+) |
| 8 | Vout (+) |

- All dimensions are in inches [mm]
- Connector Material: Copper
- Connector Finish: Tin/Lead over Nickel
Optional: Gold over Nickel
- Converter Weight: 0.53 oz [15 g]
- Recommended Surface-Mount Pads:
Min. 0.080" x 0.112" [2.03 x 2.84]
Max. 0.092" x 0.124" [2.34 x 3.15]

Converter Part Numbering Scheme

| Product Series | Input Voltage | Mounting Scheme | Rated Load Current | Output Voltage | | ON/OFF Logic | Maximum Height | Pin Length | Special Features |
|-------------------------|---------------|-----------------|--------------------|----------------|---|------------------------------|----------------|------------|------------------|
| ASQ | 48 | S | 15 | 033 | - | N | S | 0 | 0 |
| One-Eighth Brick Format | 36-75 V | Surface Mount | 15 ADC | 033 ⇒ 3.3 V | | N ⇒ Negative P ⇒ Positive | S ⇒ 0.273" | 0 ⇒ 0.00" | 0 ⇒ STD |

The example above describes P/N ASQ48S15033-NS00: 36-75 V input, surface mounting, 15 A @ 3.3 V output, negative ON/OFF logic. Please consult factory regarding availability of a specific version.

Operation

Input and Output Impedance

These power converters have been designed to be stable with no external capacitors when used in low inductance input and output circuits.

However, in many applications, the inductance associated with the distribution from the power source to the input of the converter can affect the stability of the converter. The addition of a 33 μF electrolytic capacitor with an ESR $< 1 \Omega$ across the input helps ensure stability of the converter. In many applications, the user has to use decoupling capacitance at the load. The power converter will exhibit stable operation with external load capacitance up to 15,000 μF .

ON/OFF (Pin 2)

The ON/OFF pin is used to turn the power converter on or off remotely via a system signal. There are two remote control options available, positive logic and negative logic and both are referenced to $V_{in(-)}$. Typical connections are shown in Fig. 2.

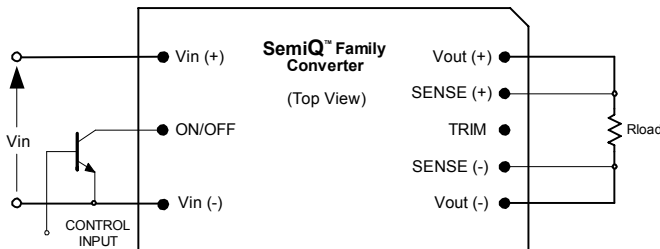

Fig. 2: Circuit configuration for ON/OFF function.

The positive logic version turns on when the ON/OFF pin is at a logic high and turns off when at a logic low. The converter is on when the ON/OFF pin is left open.

The negative logic version turns on when the pin is at a logic low and turns off when the pin is at a logic high. The ON/OFF pin can be hard wired directly to $V_{in(-)}$ to enable automatic power up of the converter without the need of an external control signal.

ON/OFF pin is internally pulled-up to 5 V through a resistor. A mechanical switch, open collector transistor, or FET can be used to drive the input of the ON/OFF pin. The device must be capable of sinking up to 0.2 mA at a low level voltage of $\leq 0.8 \text{ V}$. An external voltage source ($\pm 20 \text{ V}$ maximum) may be connected directly to the ON/OFF input, in which

case it must be capable of sourcing or sinking (depending on the signal polarity) up to 1 mA. See the Start-up Information section for system timing waveforms associated with use of the ON/OFF pin.

Remote Sense (Pins 5 and 7)

The remote sense feature of the converter compensates for voltage drops occurring between the output pins of the converter and the load. The SENSE(-) (Pin 5) and SENSE(+) (Pin 7) pins should be connected at the load or at the point where regulation is required (see Fig. 3).

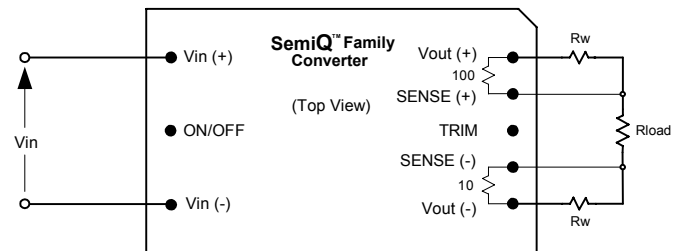

Fig. 3: Remote sense circuit configuration.

If remote sensing is not required, the SENSE(-) pin must be connected to the $V_{out(-)}$ pin (Pin 4), and the SENSE(+) pin must be connected to the $V_{out(+)}$ pin (Pin 8) to ensure the converter will regulate at the specified output voltage. If these connections are not made, the converter will deliver an output voltage that is slightly higher than the specified value.

Because the sense leads carry minimal current, large traces on the end-user board are not required. However, sense traces should be located close to a ground plane to minimize system noise and insure optimum performance. When wiring discretely, twisted pair wires should be used to connect the sense lines to the load to reduce susceptibility to noise.

The converter's output over-voltage protection (OVP) senses the voltage across $V_{out(+)}$ and $V_{out(-)}$, and not across the sense lines, so the resistance (and resulting voltage drop) between the output pins of the converter and the load should be minimized to prevent unwanted triggering of the OVP.

When utilizing the remote sense feature, care must be taken not to exceed the maximum allowable output power capability of the converter, equal to the product of the nominal output voltage and the allowable output current for the given conditions.

When using remote sense, the output voltage at the converter can be increased by as much as 10% above the

nominal rating in order to maintain the required voltage across the load. Therefore, the designer must, if necessary, decrease the maximum current (originally obtained from the derating curves) by the same percentage to ensure the converter's actual output power remains at or below the maximum allowable output power.

Output Voltage Adjust /TRIM (Pin 6)

The converter's output voltage can be adjusted up 10% or down 20% relative to the rated output voltage by the addition of an externally connected resistor. Trim up to 10% is guaranteed only at $V_{in} \geq 40$ V, and it is marginal (8% to 10%) at $V_{in} = 36$ V.

The TRIM pin should be left open if trimming is not being used. To minimize noise pickup, a 0.1 μ F capacitor is connected internally between the TRIM and SENSE(-) pins.

To increase the output voltage, refer to Fig. 4. A trim resistor, R_{T-INCR} , should be connected between the TRIM (Pin 6) and SENSE(+) (Pin 7), with a value of:

$$R_{T-INCR} = \frac{5.11(100 + \Delta)V_{O-NOM} - 626}{1.225\Delta} - 10.22 \text{ [k}\Omega\text{]}$$

where,

R_{T-INCR} = Required value of trim-up resistor $k\Omega$

V_{O-NOM} = Nominal value of output voltage [V]

$$\Delta = \frac{(V_{O-REQ} - V_{O-NOM})}{V_{O-NOM}} \times 100 \text{ [%]}$$

V_{O-REQ} = Desired (trimmed) output voltage [V].

When trimming up, care must be taken not to exceed the converter's maximum allowable output power. See previous section for a complete discussion of this requirement.

To decrease the output voltage (Fig. 5), a trim resistor, R_{T-DECR} , should be connected between the TRIM (Pin 6) and SENSE(-) (Pin 5), with a value of:

$$R_{T-DECR} = \frac{511}{|\Delta|} - 10.22 \text{ [k}\Omega\text{]}$$

where,

R_{T-DECR} = Required value of trim-down resistor $k\Omega$

and Δ is as defined above.

Note: The above equations for calculation of trim resistor values match those typically used in conventional industry-standard quarter and one-eighth bricks. For more information see Application Note 103.

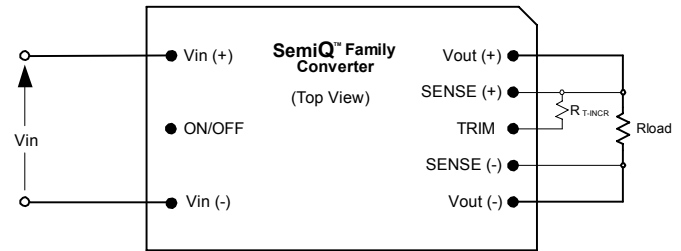

Fig. 4: Configuration for increasing output voltage.

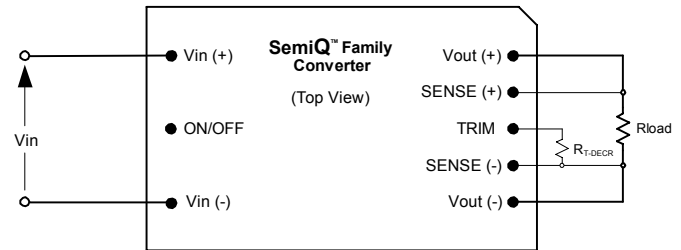

Fig. 5: Configuration for decreasing output voltage.

Trimming/sensing beyond 110% of the rated output voltage is not an acceptable design practice, as this condition could cause unwanted triggering of the output over-voltage protection (OVP) circuit. The designer should ensure that the difference between the voltages across the converter's output pins and its sense pins does not exceed 0.33 V, or:

$$[V_{OUT(+)} - V_{OUT(-)}] - [V_{SENSE(+)} - V_{SENSE(-)}] \leq 0.33 \text{ [V]}$$

This equation is applicable for any condition of output sensing and/or output trim.

Protection Features

Input Undervoltage Lockout

Input undervoltage lockout is standard with this converter. The converter will shut down when the input voltage drops below a pre-determined voltage.

The input voltage must be at least 35 V for the converter to turn on. Once the converter has been turned on, it will shut off when the input voltage drops below 31 V. This feature is beneficial in preventing deep discharging of batteries used in telecom applications.

Output Overcurrent Protection (OCP)

The converter is protected against overcurrent or short circuit conditions. Upon sensing an overcurrent condition, the converter will switch to constant current operation and thereby begin to reduce output voltage. When the output voltage drops below 1.2 VDC, the converter will shut down (Fig. 25).

Once the converter has shut down, it will attempt to restart nominally every 100 ms with a 1% duty cycle (Fig 26). The attempted restart will continue indefinitely until the overload or short circuit conditions are removed or the output voltage rises above 1.2 VDC.

Output Overvoltage Protection (OVP)

The converter will shut down if the output voltage across Vout(+) (Pin 8) and Vout(-) (Pin 4) exceeds the threshold of the OVP circuitry. The OVP circuitry contains its own reference, independent of the output voltage regulation loop. Once the converter has shut down, it will attempt to restart every 100 ms until the OVP condition is removed.

Overtemperature Protection (OTP)

The converter will shut down under an overtemperature condition to protect itself from overheating caused by operation outside the thermal derating curves, or operation in abnormal conditions such as system fan failure. After the converter has cooled to a safe operating temperature, it will automatically restart.

Safety Requirements

The converters meet North American and International safety regulatory requirements per UL60950 and EN60950. Basic Insulation is provided between input and output.

To comply with safety agencies requirements, an input line fuse must be used external to the converter. A 4-A fuse is recommended for use with this product.

If one input fuse is used for a group of modules, the maximum fuse rating should not exceed 15-A (ASQ modules are UL approved with up to a 15-A fuse).

Electromagnetic Compatibility (EMC)

EMC requirements must be met at the end-product system level, as no specific standards dedicated to EMC characteristics of board mounted component dc-dc converters exist. However, di/dt tests its converters to several system level standards, primary of which is the more stringent EN55022, *Information technology equipment - Radio disturbance characteristics - Limits and methods of measurement*.

With the addition of a simple external filter (see application notes), the ASQ48T/S15 converters pass the requirements of Class B conducted emissions per EN55022 and FCC, and meet at a minimum, Class A radiated emissions per EN 55022 and Class B per FCC Title 47CFR, Part 15-J. Please contact di/dt Applications Engineering for details of this testing.

ASQ48T15033 & ASQ48S15033 DC-DC Converter Data Sheet

36 to 75 VDC Input; 15A, 3.3 VDC Output



Characterization

General Information

The converter has been characterized for many operational aspects, to include thermal derating (maximum load current as a function of ambient temperature and airflow) for vertical and horizontal mounting, efficiency, start-up and shutdown parameters, output ripple and noise, transient response to load step-change, overload and short circuit.

The following pages contain specific plots or waveforms associated with the converter. Additional comments for specific data are provided below.

Test Conditions

All data presented were taken with the converter soldered to a test board, specifically a 0.060" thick printed wiring board (PWB) with four layers. The top and bottom layers were not metalized. The two inner layers, comprising two-ounce copper, were used to provide traces for connectivity to the converter.

The lack of metalization on the outer layers as well as the limited thermal connection ensured that heat transfer from the converter to the PWB was minimized. This provides a worst-case but consistent scenario for thermal derating purposes.

All measurements requiring airflow were made in di/dt's vertical and horizontal wind tunnel facilities using Infrared (IR) thermography and thermocouples for thermometry.

Ensuring components on the converter do not exceed their ratings is important to maintaining high reliability. If one anticipates operating the converter at or close to the maximum loads specified in the derating curves, it is prudent to check actual operating temperatures in the application. Thermographic imaging is preferable; if this capability is not available, then thermocouples may be used. di/dt recommends the use of AWG #40 gauge thermocouples to ensure measurement accuracy. Careful routing of the thermocouple leads will further minimize measurement error. Refer to Figure 27 for optimum measuring thermocouple location.

Thermal Derating

Load current vs. ambient temperature and airflow rates are given in Figs. 9-12 for through-hole and surface mount version. Ambient temperature was varied between 25°C and 85°C, with airflow rates from 30 to 500 LFM (0.15 to 2.5 m/s), and vertical and horizontal converter mounting.

For each set of conditions, the maximum load current was defined as the lowest of:

- (i) The output current at which any FET junction temperature does not exceed a maximum specified temperature (120°C) as indicated by the thermographic image, or
- (ii) The nominal rating of the converter (15 A).

During normal operation, derating curves with maximum FET temperature less or equal to 120°C should not be exceeded. Temperature on the PCB at the thermocouple location shown in Fig. 27 should not exceed 118°C in order to operate inside the derating curves.

Efficiency

Figure 13 shows the efficiency vs. load current plot for ambient temperature of 25 °C, airflow rate of 300 LFM (1.5 m/s) with converter mounted vertically, and input voltages of 36 V, 48 V, and 72 V. Also, a plot of efficiency vs. load current, as a function of ambient temperature with $V_{in} = 48$ V, airflow rate of 200 LFM (1 m/s) with converter mounted vertically is shown in Fig. 14.

Power Dissipation

Power dissipation vs. load current plot is shown in Fig. 15 for ambient temperature of 25 °C, airflow rate of 300 LFM (1.5 m/s) with converter mounted vertically, and input voltages of 36 V, 48 V, and 72 V. Also, a plot of power dissipation vs. load current, as a function of ambient temperature with $V_{in} = 48$ V, airflow rate of 200 LFM (1 m/s) is shown for a vertically mounted converter in Fig. 16

Start-up

Output voltage waveforms, during the turn-on transient using the ON/OFF pin for full rated load currents (resistive load) are shown without and with 10,000 μ F load capacitance in Figs. 17 and 18, respectively.

Ripple and Noise

Figure 21 shows the output voltage ripple waveform, measured at full rated load current with a 10 μ F tantalum and 1 μ F ceramic capacitor across the output. Note that all output voltage waveforms are measured across a 1 μ F ceramic capacitor.

The input reflected ripple current waveforms are obtained using the test setup shown in Fig 22. The corresponding waveforms are shown in Figs. 23 and 24.

ASQ48T15033 & ASQ48S15033 DC-DC Converter Data Sheet

36 to 75 VDC Input; 15A, 3.3 VDC Output



Start-up Information (using negative ON/OFF)

Scenario #1: Initial Start-up From Bulk Supply
ON/OFF function enabled, converter started via application of V_{IN} . See Figure 6.

| Time | Comments |
|-------|---|
| t_0 | ON/OFF pin is ON; system front end power is toggled on, V_{IN} to converter begins to rise. |
| t_1 | V_{IN} crosses Under-Voltage Lockout protection circuit threshold; converter enabled. |
| t_2 | Converter begins to respond to turn-on command (converter turn-on delay). |
| t_3 | Converter V_{OUT} reaches 100% of nominal value. |

For this example, the total converter start-up time ($t_3 - t_1$) is typically 4 ms.

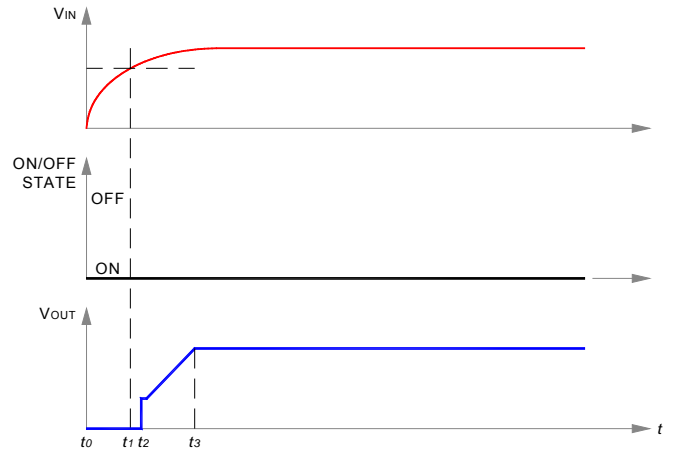

Scenario #2: Initial Start-up Using ON/OFF Pin
With V_{IN} previously powered, converter started via ON/OFF pin. See Figure 7.

| Time | Comments |
|-------|--|
| t_0 | V_{INPUT} at nominal value. |
| t_1 | Arbitrary time when ON/OFF pin is enabled (converter enabled). |
| t_2 | End of converter turn-on delay. |
| t_3 | Converter V_{OUT} reaches 100% of nominal value. |

For this example, the total converter start-up time ($t_3 - t_1$) is typically 4 ms.

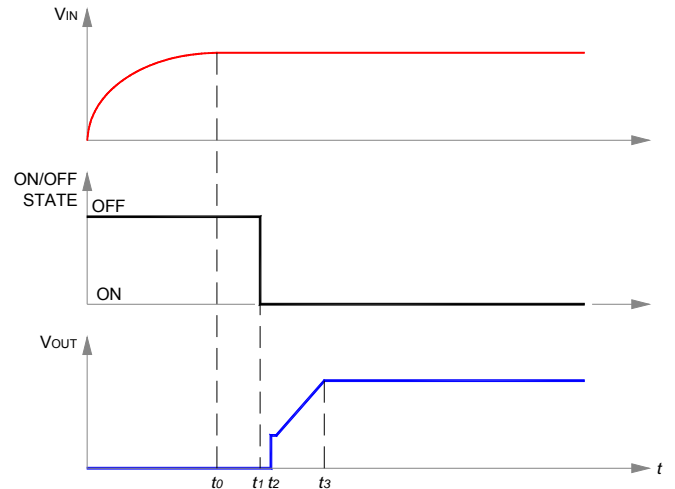

Fig. 7: Start-up scenario #2.

Scenario #3: Turn-off and Restart Using ON/OFF Pin
With V_{IN} previously powered, converter is disabled and then enabled via ON/OFF pin. See Figure 8.

| Time | Comments |
|-------|---|
| t_0 | V_{IN} and V_{OUT} are at nominal values; ON/OFF pin ON. |
| t_1 | ON/OFF pin arbitrarily disabled; converter output falls to zero; turn-on inhibit delay period (100 ms typical) is initiated, and ON/OFF pin action is internally inhibited. |
| t_2 | ON/OFF pin is externally re-enabled. If $(t_2 - t_1) \leq 100$ ms, external action of ON/OFF pin is locked out by start-up inhibit timer. If $(t_2 - t_1) > 100$ ms, ON/OFF pin action is internally enabled. |
| t_3 | Turn-on inhibit delay period ends. If ON/OFF pin is ON, converter begins turn-on; if off, converter awaits ON/OFF pin ON signal; see Figure 7. |
| t_4 | End of converter turn-on delay. |
| t_5 | Converter V_{OUT} reaches 100% of nominal value. |

For the condition, $(t_2 - t_1) \leq 100$ ms, the total converter start-up time ($t_5 - t_2$) is typically 104 ms. For $(t_2 - t_1) > 100$ ms, start-up will be typically 4 ms after release of ON/OFF pin.

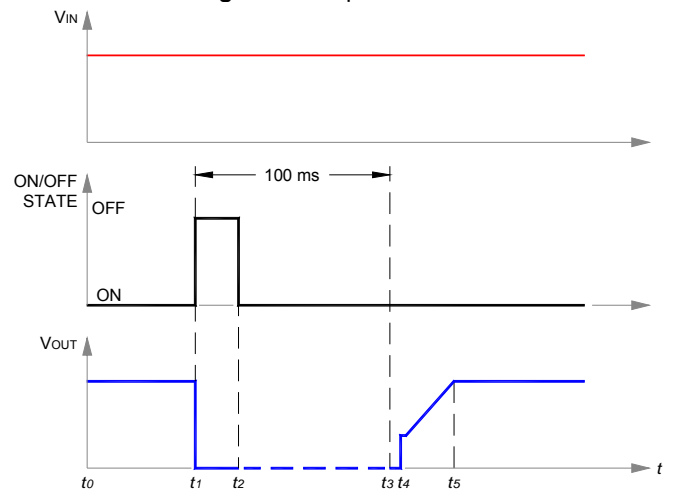

Fig. 8: Start-up scenario #3.

Fig. 6: Start-up scenario #1.

ASQ48T15033 & ASQ48S15033 DC-DC Converter Data Sheet

36 to 75 VDC Input; 15A, 3.3 VDC Output

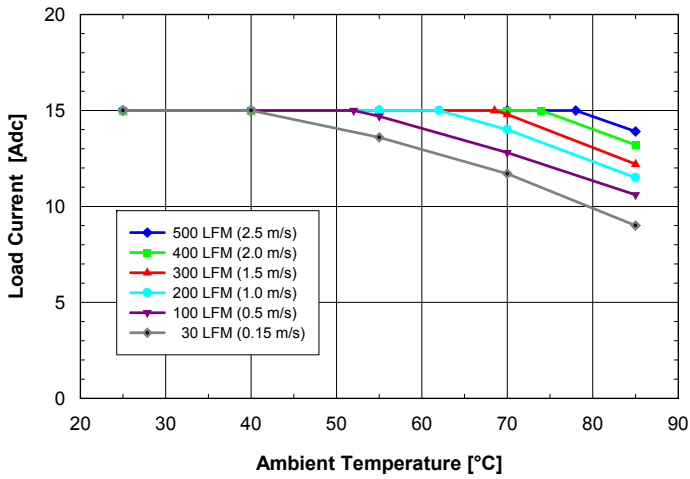

Fig. 9: Available load current vs. ambient air temperature and airflow rates for **ASQ48T15033** converter with **D** height pins mounted vertically with $V_{in} = 48\text{ V}$, air flowing from pin 3 to pin 1 and maximum FET temperature $\leq 120^{\circ}\text{C}$.

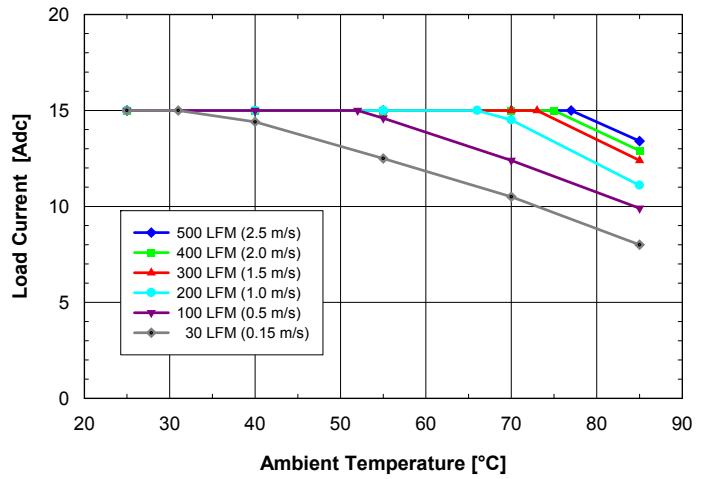

Fig. 10: Available load current vs. ambient air temperature and airflow rates for **ASQ48T15033** converter with **D** height pins mounted horizontally with $V_{in} = 48\text{ V}$, air flowing from pin 3 to pin 1 and maximum FET temperature $\leq 120^{\circ}\text{C}$.

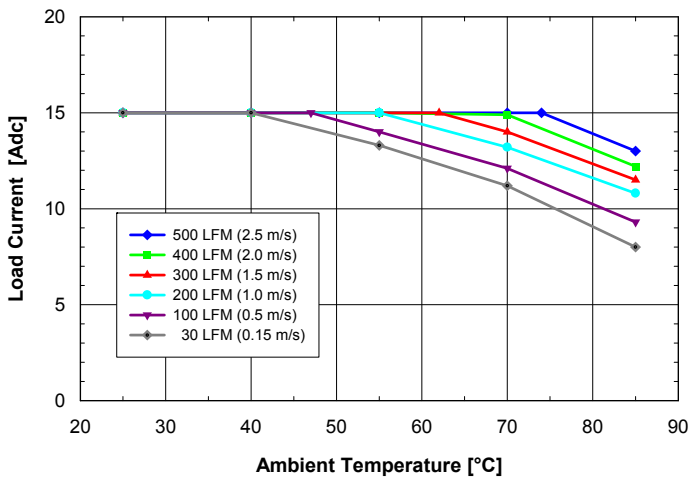

Fig. 11: Available load current vs. ambient temperature and airflow rates for **ASQ48S15033** converter mounted vertically with $V_{in} = 48\text{ V}$, air flowing from pin 3 to pin 1 and maximum FET temperature $\leq 120^{\circ}\text{C}$.

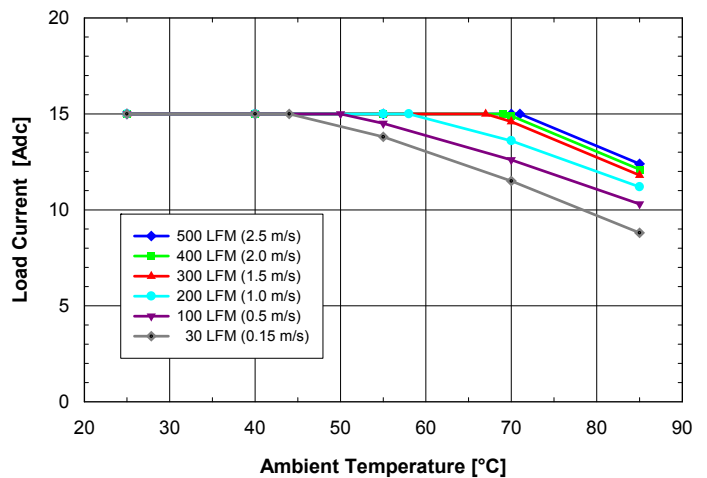

Fig. 12: Available load current vs. ambient temperature and airflow rates for **ASQ48S15033** converter mounted horizontally with $V_{in} = 48\text{ V}$, air flowing from pin 3 to pin 1 and maximum FET temperature $\leq 120^{\circ}\text{C}$.

ASQ48T15033 & ASQ48S15033 DC-DC Converter Data Sheet

36 to 75 VDC Input; 15A, 3.3 VDC Output

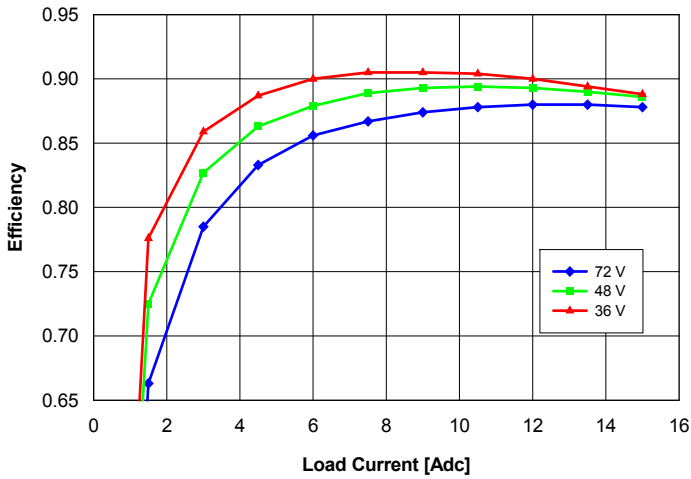

Fig. 13: Efficiency vs. load current and input voltage for converter mounted vertically with air flowing from pin 3 to pin 1 at a rate of 300 LFM (1.5 m/s) and $T_a = 25^\circ\text{C}$.

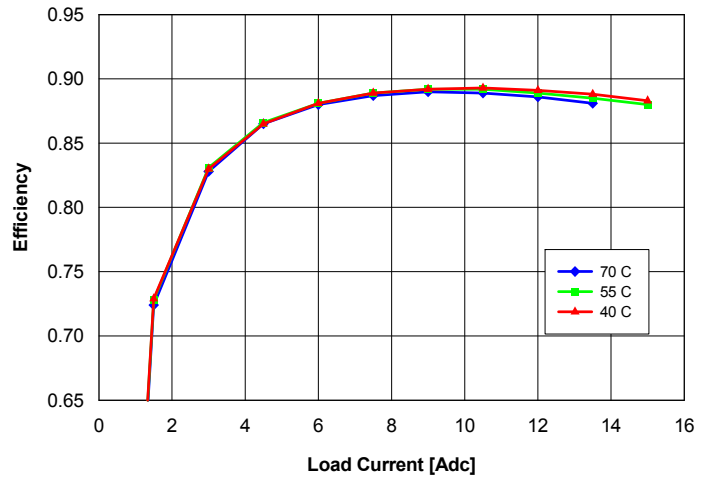

Fig. 14: Efficiency vs. load current and ambient temperature for converter mounted vertically with $V_{in} = 48\text{ V}$ and air flowing from pin 3 to pin 1 at a rate of 200 LFM (1.0 m/s).

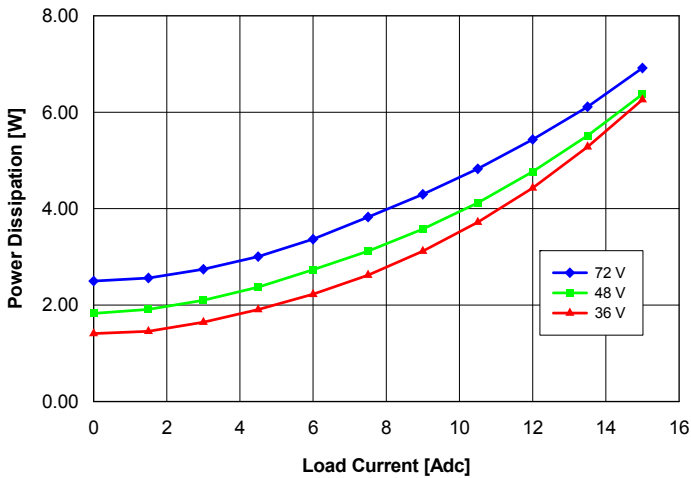

Fig. 15: Power dissipation vs. load current and input voltage for converter mounted vertically with air flowing from pin 3 to pin 1 at a rate of 300 LFM (1.5 m/s) and $T_a = 25^\circ\text{C}$.

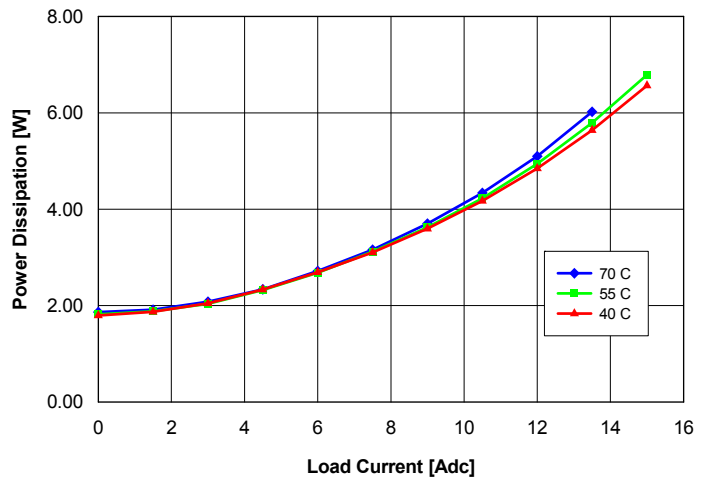

Fig. 16: Power dissipation vs. load current and ambient temperature for converter mounted vertically with $V_{in} = 48\text{ V}$ and air flowing from pin 3 to pin 1 at a rate of 200 LFM (1.0 m/s).

ASQ48T15033 & ASQ48S15033 DC-DC Converter Data Sheet
36 to 75 VDC Input; 15A, 3.3 VDC Output

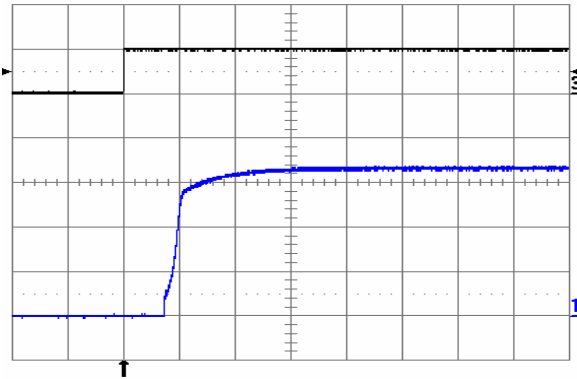

Fig. 17: Turn-on transient at full rated load current (resistive) with no output capacitor at $V_{in} = 48\text{ V}$, triggered via ON/OFF pin. Top trace: ON/OFF signal (5 V/div.). Bottom trace: output voltage (1 V/div.) Time scale: 2 ms/div.

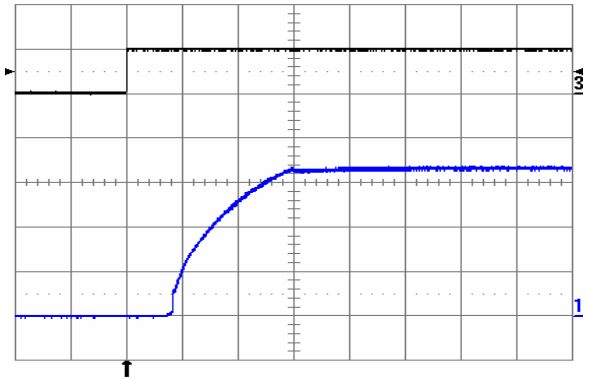

Fig. 18: Turn-on transient at full rated load current (resistive) plus 10,000 μF at $V_{in} = 48\text{ V}$, triggered via ON/OFF pin. Top trace: ON/OFF signal (5 V/div.). Bottom trace: output voltage (1 V/div.). Time scale: 2 ms/div.

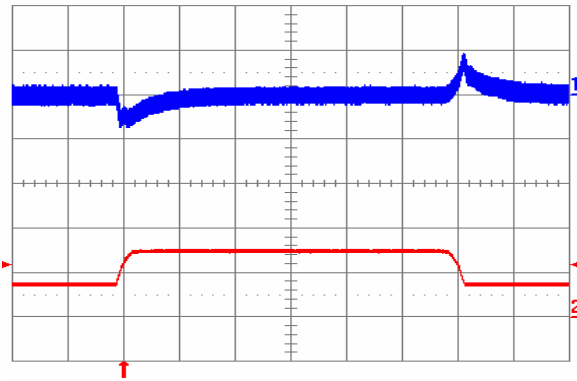

Fig. 19: Output voltage response to load current step-change (3.75 A – 7.5 A – 3.75 A) at $V_{in} = 48\text{ V}$. Top trace: output voltage (100 mV/div). Bottom trace: load current (5 A/div.). Current slew rate: 0.1 A/ μs . $C_o = 1\ \mu\text{F}$ ceramic. Time scale: 0.2 ms/div.

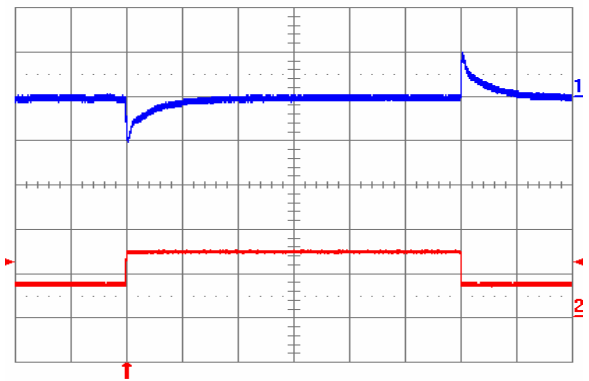

Fig. 20: Output voltage response to load current step-change (3.75 A – 7.5 A – 3.75 A) at $V_{in} = 48\text{ V}$. Top trace: output voltage (100 mV/div). Bottom trace: load current (5 A/div.). Current slew rate: 5 A/ μs . $C_o = 450\ \mu\text{F}$ tantalum + 1 μF ceramic. Time scale: 0.2 ms/div.

ASQ48T15033 & ASQ48S15033 DC-DC Converter Data Sheet

36 to 75 VDC Input; 15A, 3.3 VDC Output

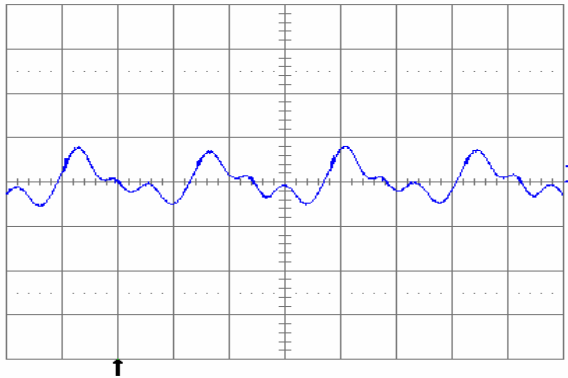

Fig. 21: Output voltage ripple (20 mV/div.) at full rated load current into a resistive load with $C_o = 10 \mu\text{F}$ tantalum + $1\mu\text{F}$ ceramic and $V_{in} = 48 \text{ V}$. Time scale: $1 \mu\text{s}/\text{div}$.

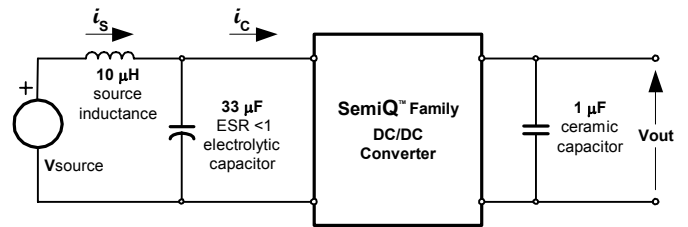

Fig. 22: Test setup for measuring input reflected ripple currents, i_c and i_s .

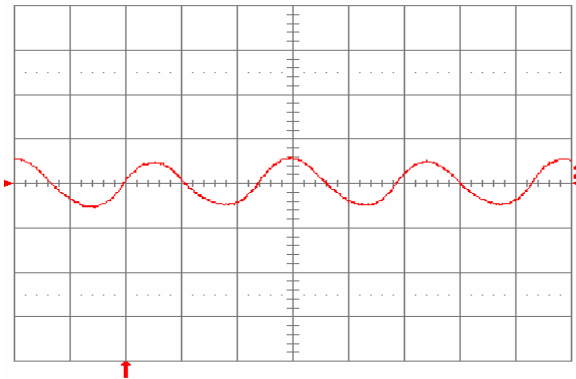

Fig. 23: Input reflected ripple current, i_c (100 mA/div), measured at input terminals at full rated load current and $V_{in} = 48 \text{ V}$. Refer to Fig. 22 for test setup. Time scale: $1 \mu\text{s}/\text{div}$.

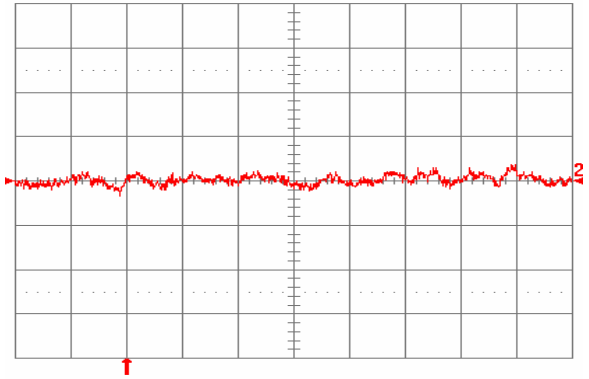

Fig. 24: Input reflected ripple current, i_s (10 mA/div), measured through $10 \mu\text{H}$ at the source at full rated load current and $V_{in} = 48 \text{ V}$. Refer to Fig. 22 for test setup. Time scale: $1\mu\text{s}/\text{div}$.

ASQ48T15033 & ASQ48S15033 DC-DC Converter Data Sheet

36 to 75 VDC Input; 15A, 3.3 VDC Output

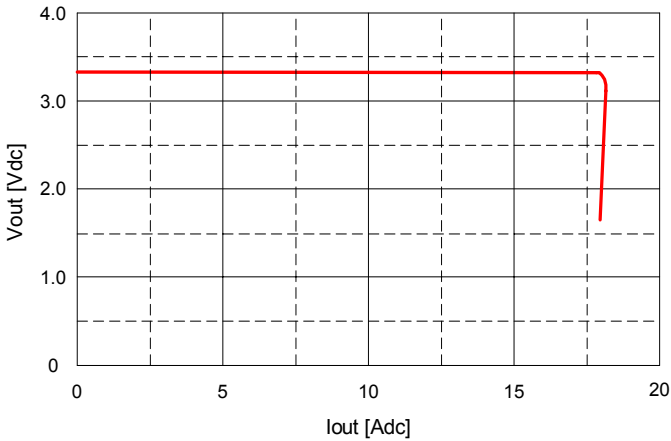

Fig. 25: Output voltage vs. load current showing current limit point and converter shutdown point. Input voltage has almost no effect on current limit characteristic.

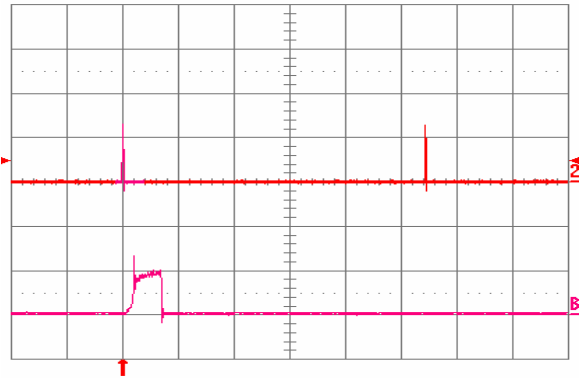

Fig. 26: Load current (top trace, 20 A/div, 20 ms/div) into a 10 mΩ short circuit during restart, at $V_{in} = 48$ V. Bottom trace (20 A/div, 1 ms/div) is an expansion of the on-time portion of the top trace.

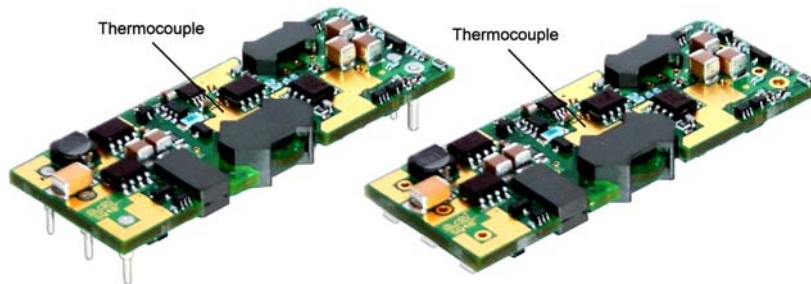

Fig. 27: Location of the thermocouple for thermal testing.

NUCLEAR AND MEDICAL APPLICATIONS - Power-One products are not designed, intended for use in, or authorized for use as critical components in life support systems, equipment used in hazardous environments, or nuclear control systems without the express written consent of the respective divisional president of Power-One, Inc.

TECHNICAL REVISIONS - The appearance of products, including safety agency certifications pictured on labels, may change depending on the date manufactured. Specifications are subject to change without notice.