

## Technical Data Sheet

### High Power LED – 1W

## EHP-AX08L/M01-P01

### Features

- Feature of the device: small package with high efficiency
- Typical color temperature: 3500 K.
- View angle: 130°.
- High light flux output: more than 34lm @ 350mA
- ESD protection.
- Soldering methods: Hot bar soldering.
- Grouping parameter: total luminous flux, color temperature.
- Optical efficiency: 26 lm/W.
- Thermal resistance (junction to lead): 15 K/W.
- The product itself will remain within RoHS compliant version.

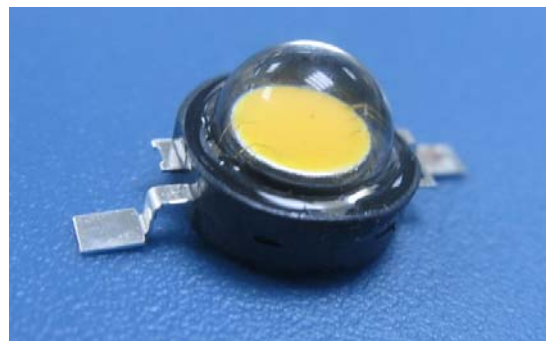

### Applications

- TFT LCD display backlight
- Decorative and entertainment illumination
- Signal and symbol luminaries for orientation marker lights (e.g. steps, exit ways, etc.)
- Exterior and interior automotive illumination

### Materials

Items	Description
Housing black body	Heat resistant polymer
Encapsulating Resin	Silicone resin
Lens	Heat resistant clear polymer
Electrodes	Ag plating copper alloy
Die attach	Silver paste
Chip	InGaN

Dimensions

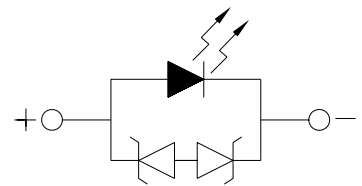
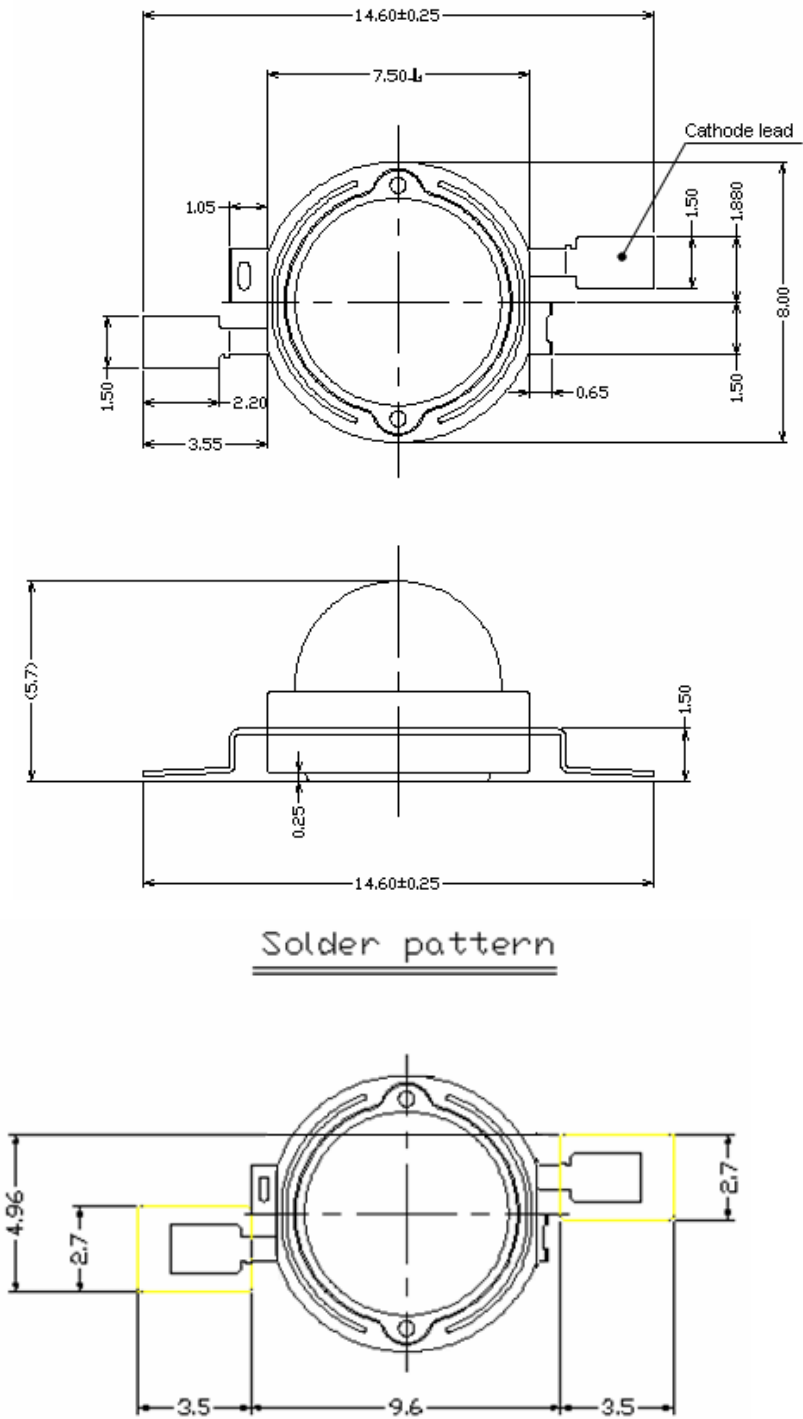

- Notes: 1. Dimensions are in millimeters
- 2. Tolerances unless dimensions  $\pm 0.25\text{mm}$

**Maximum Ratings ( $T_{Ambient}=25^{\circ}C$ )**

Parameter	Symbol	Rating	Unit
Operating Temperature	$T_{opr}$	-40 ~ +100	°C
Storage Temperature	$T_{stg}$	-40 ~ +100	°C
Junction temperature	$T_j$	125	°C
Forward Current	$I_F$	500	mA
Power Dissipation	$P_d$	2.1	W
Junction to heat-sink thermal resistance	$R_{th}$	15	K/W

**Electro-Optical Characteristics ( $T_{Ambient}=25^{\circ}C$ )**

Parameter	Bin	Symbol	Min	Typ.	Max	Unit	Condition
Luminous Flux <sub>(1)</sub>	J1	$\phi_v$	23	----	27	lm	$I_F=350mA$
	J2		27	----	33		
	J3		33	----	39		
	J4		39	----	45		
Viewing Angle <sub>(2)</sub>	----	$2\theta_{1/2}$	----	130	----	deg	
Forward Voltage <sub>(3)</sub>	V2	$V_F$	3.25	----	3.55	V	
	V3		3.55	----	3.85		
	V4		3.85	----	4.15		

Note. 1. Luminous flux measurement tolerance :  $\pm 10\%$

2.  $2\theta_{1/2}$  is the off axis angle from lamp centerline where the luminous intensity is 1/2 of the peak value.

3. Forward Voltage measurement tolerance :  $\pm 0.1V$

**EHP-AX08L/M01-P01**

**Color Binning**

Rank WA				
x	0.361	0.398	0.389	0.357
y	0.384	0.411	0.382	0.361
Reference CCT: 4000K-4500K				

Rank WB				
x	0.357	0.389	0.382	0.353
y	0.361	0.382	0.356	0.340
Reference CCT: 4000K-4500K				

Rank WC				
x	0.389	0.398	0.440	0.425
y	0.382	0.411	0.431	0.400
Reference CCT: 3175K-3800K				

Rank WD				
x	0.382	0.389	0.425	0.412
y	0.356	0.382	0.400	0.372
Reference CCT: 3175K-3800K				

Rank WE				
x	0.425	0.440	0.497	0.477
y	0.400	0.431	0.446	0.414
Reference CCT: 2500K-3175K				

Rank WF				
x	0.412	0.425	0.477	0.458
y	0.372	0.400	0.414	0.383
Reference CCT: 2500K-3175K				

Note. 1. Color coordinates measurement allowance :  $\pm 0.01$

2. CCT value is only for reference.

**Color Binning Structure Graphic Representation**

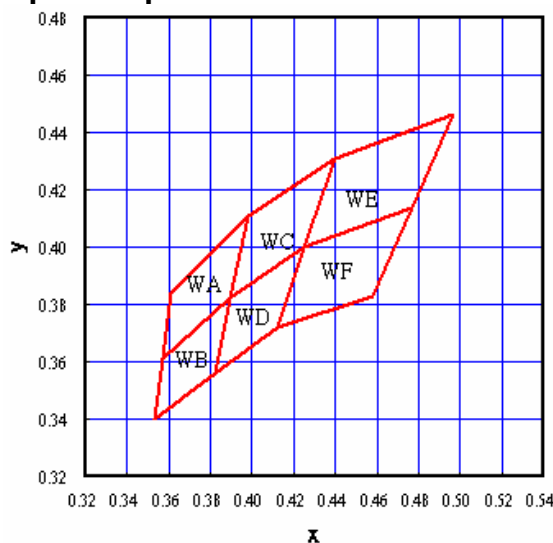

Typical Electro-Optical Characteristics Curves

Relative Spectral Distribution,  
 $I_F=350\text{mA}$ ,  $T_{\text{Ambient}}=25^\circ\text{C}$

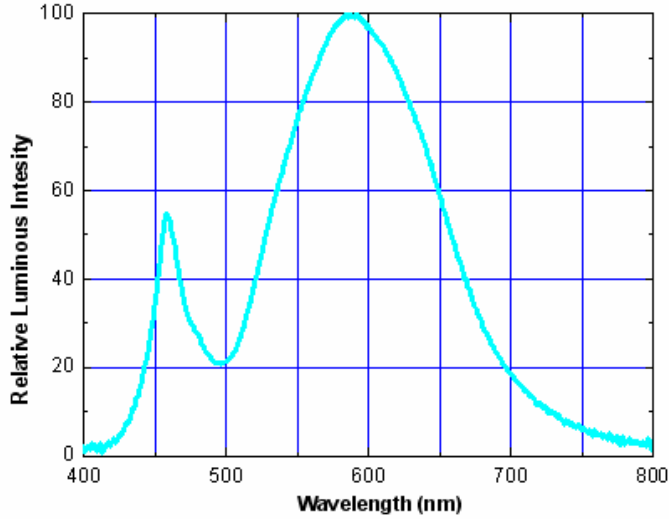

Forward Voltage vs Forward Current,  
 $T_{\text{Ambient}}=25^\circ\text{C}$

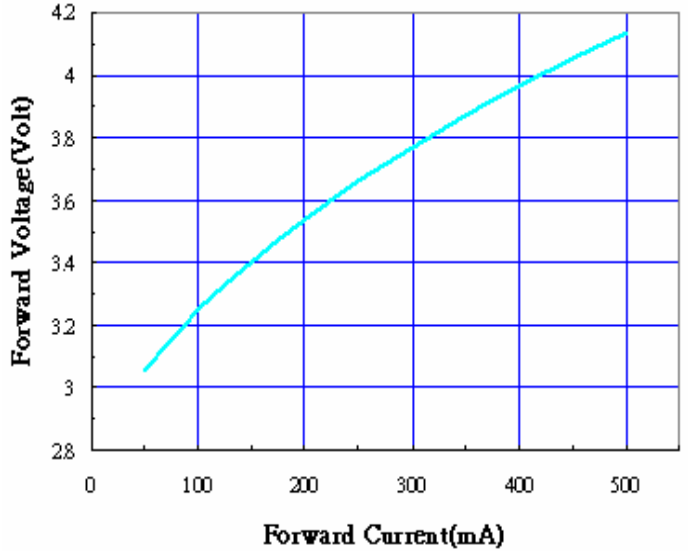

Relative Luminous Intensity vs Forward Current,  $T_{\text{Ambient}}=25^\circ\text{C}$

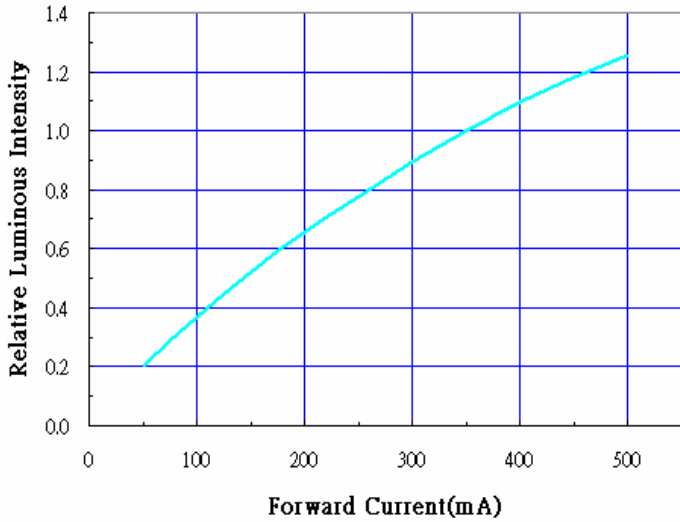

Forward Current Derating Curve,  
 Derating based on  $T_{\text{JMAX}}=125^\circ\text{C}$

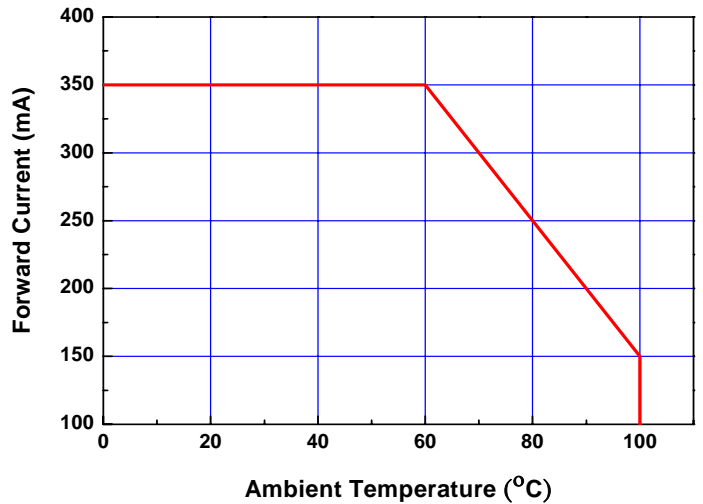

**Typical Representative Spatial Radiation Pattern**

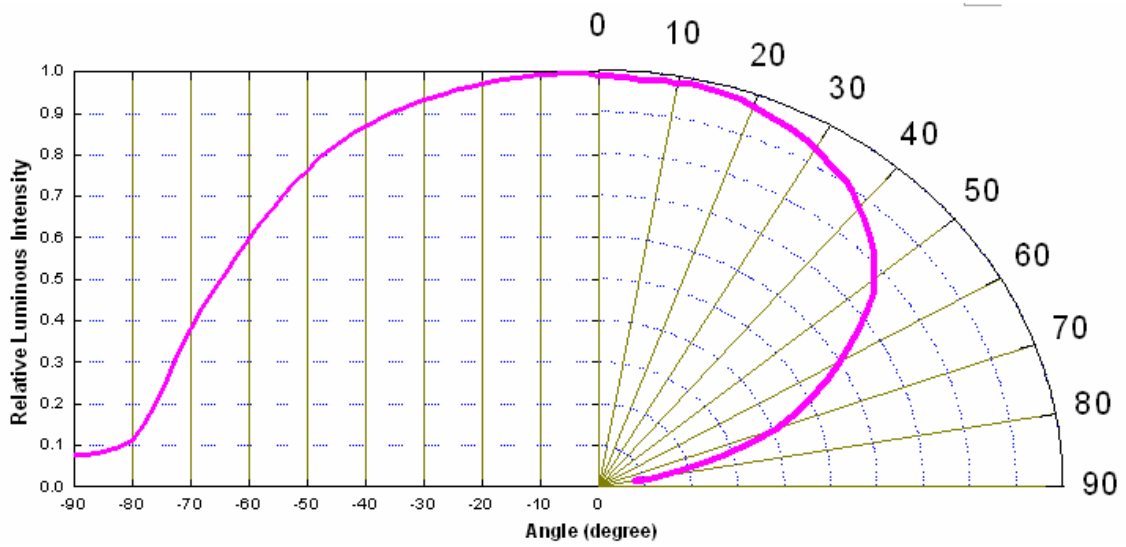

Label explanation

CPN: Customer's Production Number

P/N : Production Number

QTY: Packing Quantity

CAT: Ranks

HUE: Peak Wavelength

REF: Reference

LOT No: Lot Number

MADE IN TAIWAN: Production Place



Tube Packing Specifications

1. Tube

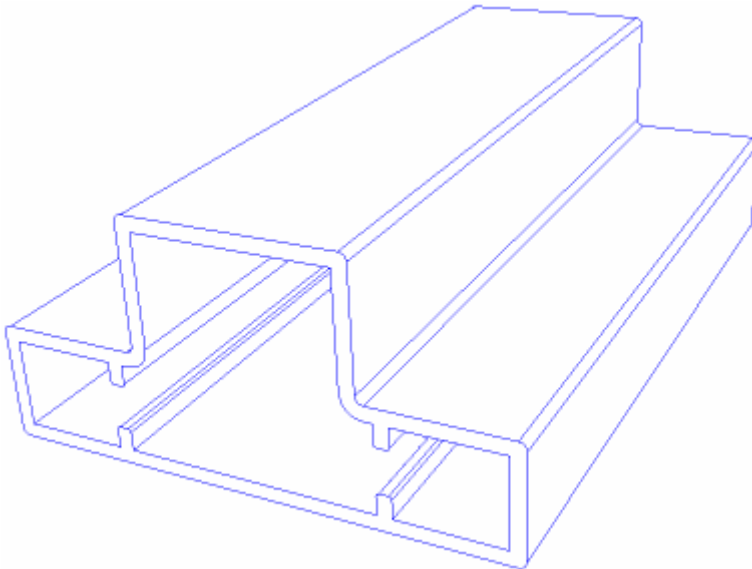

EHP-AX08L/M01-P01

2. Inner Carton

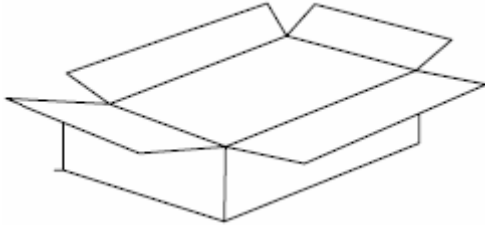

3. Outside Carton

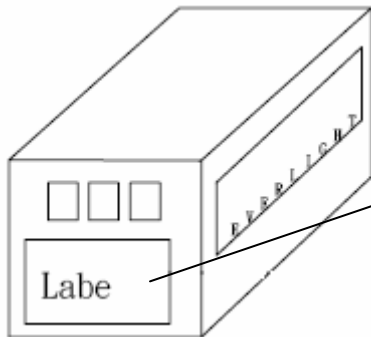

● Packing Quantity

- 1. 60 Pcs / Per Tube
- 2. 20 Tubes / Inner Carton
- 3. 12 Inner Cartons / Outside Carton



**Reliability Test Items and Results**

Stress Test	Stress Condition	Stress Duration
Solderability	Tsol=230°C, 5sec	1 times
Resistance to Solder Heat	Tsol=260°C, 10sec, 6min	3 times
Thermal Shock	H : +110°C 20min. ↓ 10sec. 'L : - 40°C 20min.	500 Cycles
Temperature Cycle	H : +100°C 30min. ↓ 5min. 'L : - 40°C 30min.	1000 Cycles
High Temperature/Humidity Reverse Bias	Ta=85°C, RH=85%	1000hours
High Temperature/Humidity Operation	Ta=85°C, RH=60%, IF=225mA	1000hours
High Temperature Storage	Ta=110°C	1000hours
Low Temperature Storage	Ta=-40°C	1000hours
Intermittent operational Life	Ta=25°C, IF=1000mA 30mS on/ 2500mS off	1000hours
High Temperature Operation Life #1	Ta=55°C, IF=350mA	1000hours
High Temperature Operation Life #2	Ta=85°C, IF=225mA	1000hours
High Temperature Operation Life #3	Ta=100°C, IF=150mA	1000hours
Low Temperature Operation Life	Ta=-40°C, IF=350mA	1000hours
Power Temperature Cycle	H : +85°C 15min. ↓ 5min. 'L : - 40°C 15min. IF=225mA, 2min on/off	1000cycles
ESD Human Body Model	2000V, Interval:0.5sec	3 times
ESD Machine Model	200V, Interval:0.5sec	3 times

\*Im: BRIGHTNESS ATTENUATE DIFFERENCE(1000hrs) < 50%

\*VF: FORWARD VOLTAGE DIFFERENCE < 20%

**Precautions For Use**
**1. Over-current-proof**

Though EHP-A08 has conducted ESD protection mechanism, customer must not use the device in reverse and should apply resistors for extra protection. Otherwise slight voltage shift may cause enormous current change and burn out failure would happen.

**2. Storage**

- i. Do not open moisture proof bag before the products are ready to use.
- ii. Before opening the package, the LEDs should be kept at 30°C or less and 90%RH or less.
- iii. The LEDs should be used within a year.
- iv. After opening the package, the LEDs should be kept at 30°C or less and 70%RH or less.
- v. The LEDs should be used within 168 hours (7 days) after opening the package.
- vi. If the moisture absorbent material (silicone gel) has faded away or the LEDs have exceeded the storage time, baking treatment should be performed using the following conditions.
- vii. Pre-curing treatment : 60±5°C for 24 hours.

**3. Thermal Management**

- i. For maintaining the high flux output and achieving reliability, EHP-A08 series LED package should be mounted on a metal core printed circuit board (MCPCB) with proper thermal connection to dissipate approximately 1W of thermal energy under 350mA operation.

**MCPCB structure**



Recommended supplier:  
 ▪ [Kavano Industrial Co., Ltd](http://www.kavano.com)  
 ▪ TT Electronics

- ii. Special thermal designs are also recommended to take in outer heat sink design, such as FR4 PCB on Aluminum with thermal vias or FPC on Aluminum with thermal conductive adhesive, etc.
- iii. Sufficient thermal management must be conducted, or the die junction temperature will be over the limit under large electronic driving and LED lifetime will decrease critically.

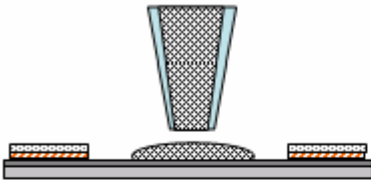
**4. Assembly process flow**

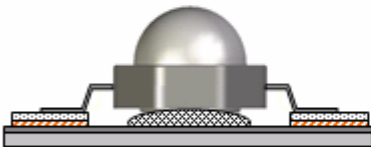

**Thermal conductive glue dispensing**  
 Recommended material and its supplier: EpoTek T7109 from Epoxy Technology



**EHP-A08 LED emitter placement**

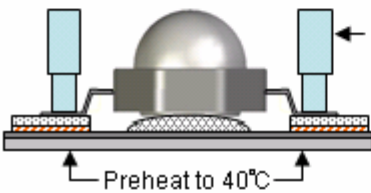

**Hot bar soldering of LED emitter**  
 Note: The MCPCB should be preheated up to 40°C for increasing the solderability

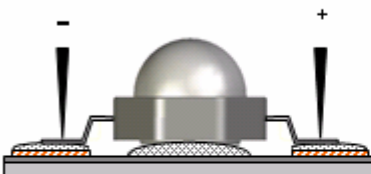

**Functional test of LED emitter**

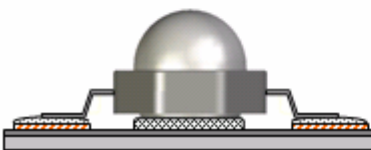

**Curing of thermal conductive glue**

Handling Indications : Do not handle the EHP-A08 by the lens at any time during the assembly process. This can cause damage to the optical surfaces or may dislocate the lens if excessive force is applied.

**5. Soldering Iron**

For prototype builds or small series production runs it is possible to place and solder the LED by hand. Dispensing thermal conductive glue or grease on the substrates and follow its curing spec. Press LED housing to closely connect LED and substrate.



- i. It is recommended to hand solder the leads with a solder tip temperature of 280°C for less than 3 seconds within once in less than the soldering iron capacity 25W. Leave two seconds and more intervals, and do soldering of each terminal.
- ii. Be careful because the damage of the product is often started at the time of the hand solder.