



■ Features :

- Universal AC input / Full range (up to 295VAC)
- Protections: Short circuit / Over current / Over voltage / Over temperature
- Output voltage and constant current level adjustable
- Built-in active PFC function
- IP66 design for indoor or outdoor installations
- Cooling by free air convection
- 100% full load burn-in test
- High reliability
- Suitable for LED lighting and moving sign applications
- Compliance to worldwide safety regulations for lighting
- Suitable for dry / damp / wet locations
- 3 years warranty

SPECIFICATION



MODEL		CEN-100-20	CEN-100-24	CEN-100-30	CEN-100-36	CEN-100-42	CEN-100-48	CEN-100-54	
OUTPUT	DC VOLTAGE	20V	24V	30V	36V	42V	48V	54V	
	CONSTANT CURRENT OPERATION VOLTAGE <small>Note.5</small>	13 ~ 20V	15.6 ~ 24V	19.5 ~ 30V	23.4 ~ 36V	27.3 ~ 42V	31.2 ~ 48V	35.1 ~ 54V	
	RATED CURRENT	4.8A	4A	3.2A	2.65A	2.28A	2A	1.77A	
	CURRENT RANGE	0 ~ 4.8A	0 ~ 4A	0 ~ 3.2A	0 ~ 2.65A	0 ~ 2.28A	0 ~ 2A	0 ~ 1.77A	
	RATED POWER	96W	96W	96W	95.4W	95.76W	96W	95.58W	
	RIPPLE & NOISE (max.) <small>Note.2</small>	2.0Vp-p	2.7Vp-p	3Vp-p	3.6Vp-p	4Vp-p	4.6Vp-p	5Vp-p	
	VOLTAGE ADJ. RANGE (SVR1)	17 ~ 22V	22 ~ 27V	27 ~ 33V	33 ~ 40V	37 ~ 46V	43 ~ 53V	49 ~ 58V	
	CURRENT ADJ. RANGE (SVR2)	3.12 ~ 4.8A	2.6 ~ 4A	2.08 ~ 3.2A	1.72 ~ 2.65A	1.48 ~ 2.28A	1.3 ~ 2A	1.15 ~ 1.77A	
	VOLTAGE TOLERANCE <small>Note.3</small>	±10%							
	LINE REGULATION	±3.0%							
LOAD REGULATION	±5.0%								
SETUP TIME	3000ms / 230VAC 5000ms / 115VAC at full load								
INPUT	VOLTAGE RANGE <small>Note.4</small>	90 ~ 295VAC 127 ~ 417VDC							
	FREQUENCY RANGE	47 ~ 63Hz							
	POWER FACTOR (Typ.)	PF>0.97/115VAC, PF>0.95/230VAC, PF>0.92/277VAC at full load (Please refer to "Power Factor Characteristic" curve)							
	EFFICIENCY (Typ.)	88%	89%	90%	90%	90%	91%	91%	
	AC CURRENT (Typ.)	1.4A/115VAC 0.7A/230VAC							
	INRUSH CURRENT (Typ.)	60A/230VAC							
LEAKAGE CURRENT	<0.75mA / 240VAC								
PROTECTION	OVER CURRENT	95 ~ 110% Protection type : Constant current limiting, recovers automatically after fault condition is removed							
	SHORT CIRCUIT	Hiccup mode, recovers automatically after fault condition is removed							
	OVER VOLTAGE	22.8 ~ 26V	28 ~ 32V	34 ~ 38V	41 ~ 46V	47 ~ 52V	54 ~ 60V	59 ~ 65V	
	OVER TEMPERATURE	100°C ±10°C (RTH1) Protection type : Shut down o/p voltage, re-power on to recover							
ENVIRONMENT	WORKING TEMP.	-30 ~ +70°C (Refer to "Derating Curve")							
	WORKING HUMIDITY	20 ~ 95% RH non-condensing							
	STORAGE TEMP., HUMIDITY	-40 ~ +80°C, 10 ~ 95% RH							
	TEMP. COEFFICIENT	±0.03%/°C (0 ~ 50°C)							
	VIBRATION	10 ~ 500Hz, 5G 12min./1cycle, period for 72min. each along X, Y, Z axes							
SAFETY & EMC	SAFETY STANDARDS	UL8750, TUV EN61347-1, EN61347-2-13, J61347-1, J61347-2-13, IP66 approved							
	WITHSTAND VOLTAGE	I/P-O/P:3.75KVAC I/P-FG:1.88KVAC O/P-FG:0.5KVAC							
	ISOLATION RESISTANCE	I/P-O/P, I/P-FG, O/P-FG: >100M Ohms / 500VDC / 25°C / 70% RH							
	EMC EMISSION	Compliance to EN55015, EN61000-3-2 Class C (≥65% load) ; EN61000-3-3							
	EMC IMMUNITY	Compliance to EN61000-4-2,3,4,5,6,8,11, EN55024, EN61547, light industry level (surge 4KV), criteria A							
OTHERS	MTBF	519.5Khrs min. MIL-HDBK-217F (25°C)							
	DIMENSION	193*62.5*40.5mm (L*W*H)							
	PACKING	0.6Kg; 24pcs/15.4Kg/1.11CUFT							
NOTE	<ol style="list-style-type: none"> 1. All parameters NOT specially mentioned are measured at 230VAC input, rated load and 25°C of ambient temperature. 2. Ripple & noise are measured at 20MHz of bandwidth by using a 12" twisted pair-wire terminated with a 0.1uf & 47uf parallel capacitor. 3. Tolerance : includes set up tolerance, line regulation and load regulation. 4. Derating may be needed under low input voltage. Please check the static characteristics for more details. 5. Constant current operation region is within 65% ~100% rated output voltage. This is the suitable operation region for LED related applications, but please reconfirm special electrical requirements for some specific system design. 6. The power supply is considered as a component that will be operated in combination with final equipment. Since EMC performance will be affected by the complete installation, the final equipment manufacturers must re-qualify EMC Directive on the complete installation again. 7. Direct connecting to LEDs is suggested, but is not suitable for using additional drivers. 								

■ Mechanical Specification

Case No. 993A Unit:mm

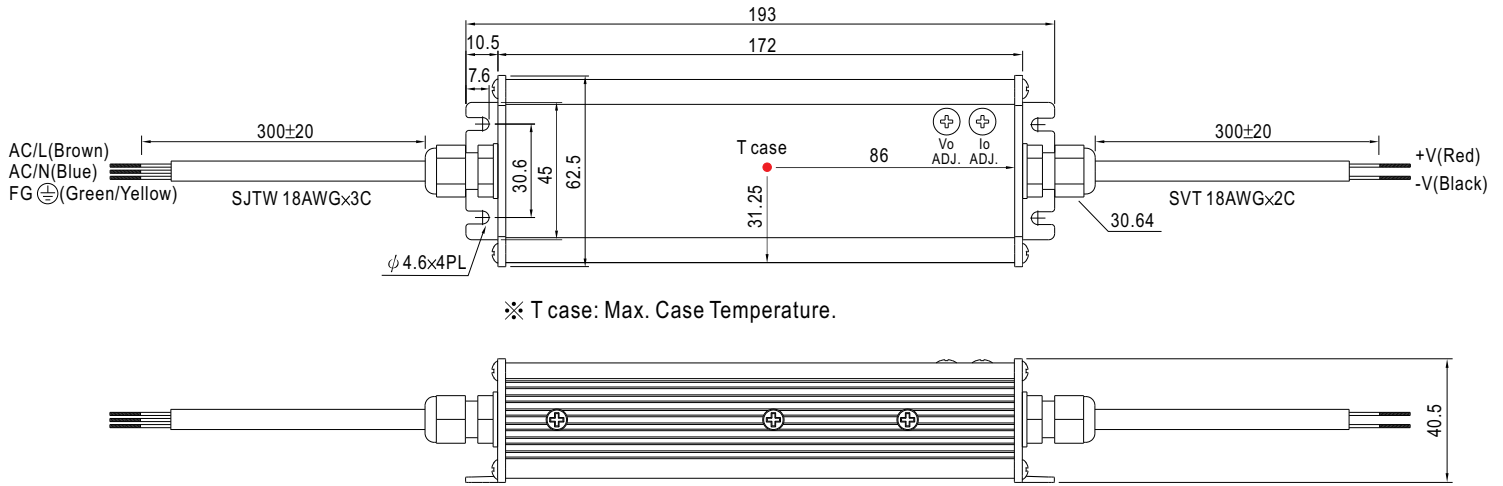

■ Block Diagram

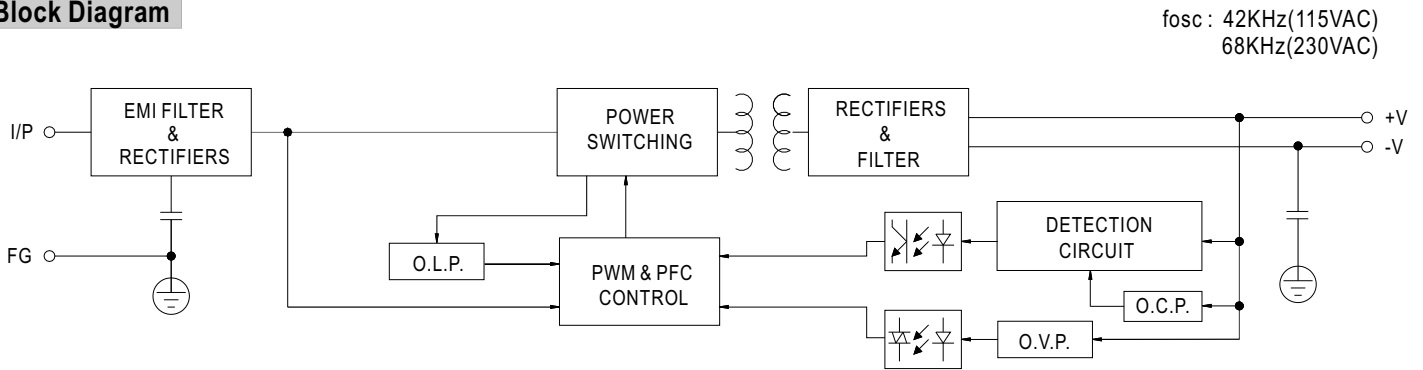

■ Derating Curve

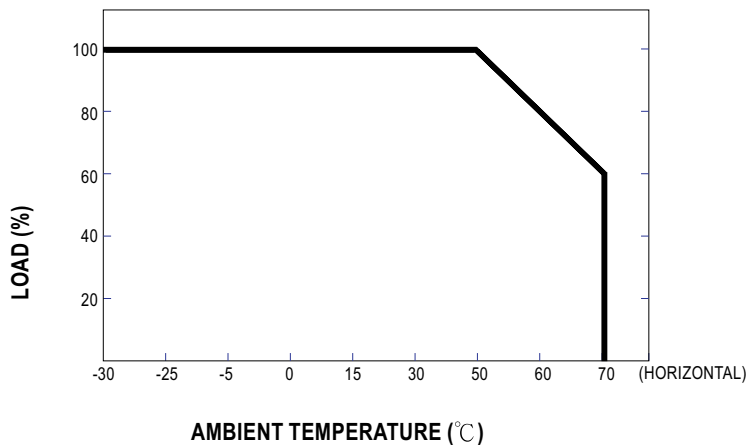

■ Static Characteristics

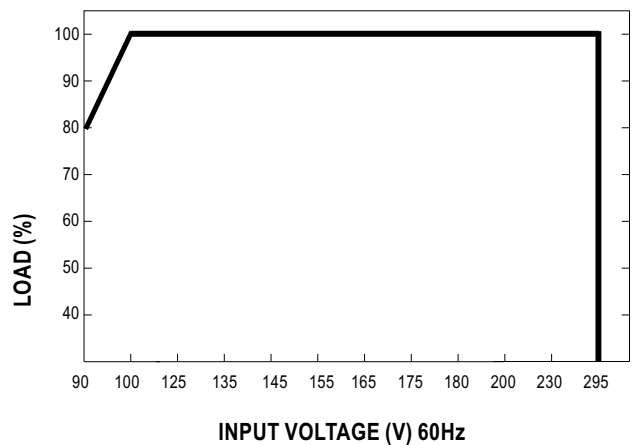

Power Factor Characteristic

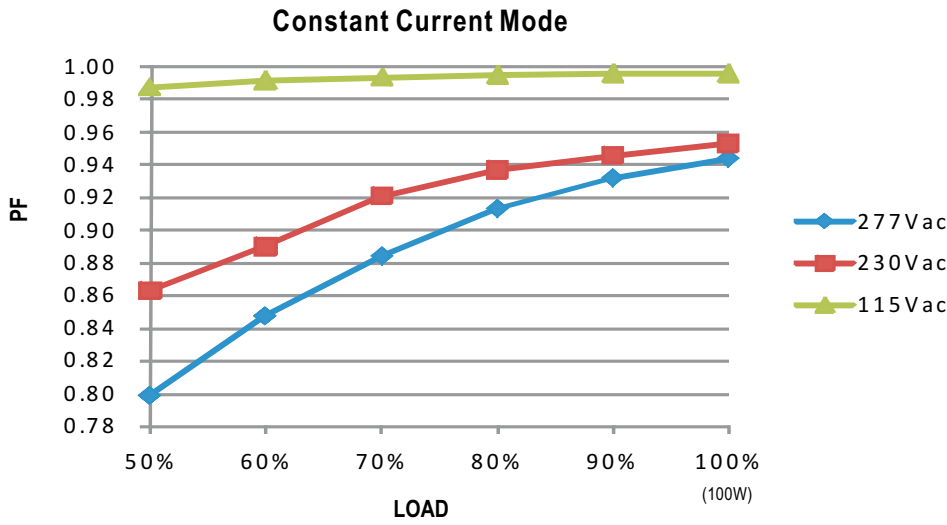

EFFICIENCY vs LOAD (48V Model)

CEN-100 series possess superior working efficiency that up to 91% can be reached in field applications.

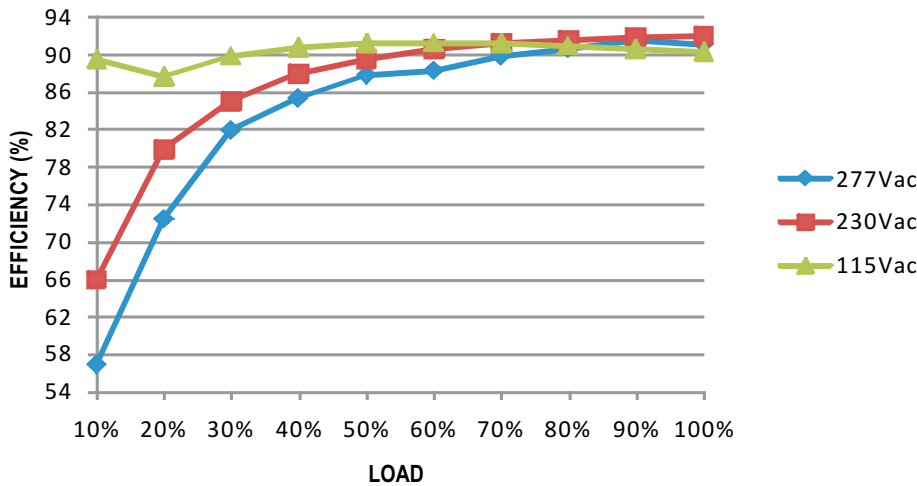

DRIVING METHODS OF LED MODULE

There are two major kinds of LED drive method "direct drive" and "with LED driver".

A typical LED power supply may either work in "constant voltage mode (CV) or constant current mode (CC)" to drive the LEDs.

Mean Well's LED power supply with CV+ CC characteristic can be operated at both CV mode [with LED driver, at area (A)] and CC mode [direct drive, at area (B)].

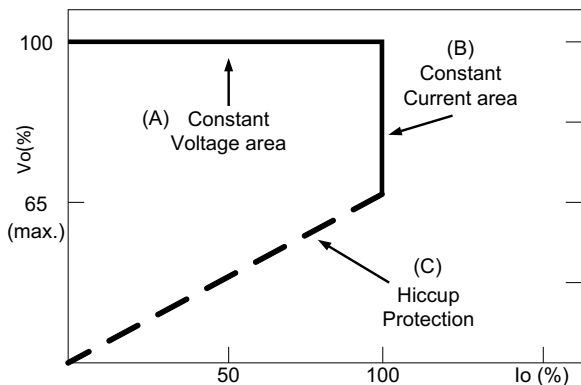

Typical LED power supply I-V curve