

# Pulse Withstanding Chip Resistors

## PWC Series

- Excellent pulse withstand performance
- Improved working voltage
- Improved power rating
- Standard chip sizes (0805 to 2512)
- Custom designs available



## Electrical Data

Size		0805	1206	2010	2512
Power @70°C	W	0.125	0.33	0.75	1.5
Resistance range	Ohms	1R0 to 10M			
Tolerance	%	10R to 1M: 0.5, All values: 1, 5			
LEV	V	150	200	400	500
TCR	ppm/°C	<10R:200 ≥10R:100			
Operating temperature	°C	-55 to +155			
Thermal Impedance	°C/W	220	160	80	50
Pad / trace area*	mm <sup>2</sup>	40	50	60	100
Values		E24 or E96 preferred other values to special order			
Pulse capability		See graphs - full application note available on request			

\*Recommended minimum pad & adjacent trace area for each termination for rated power dissipation on FR4 PCB

## Physical Data

Dimensions of PWC resistors are given below in mm and weight in g							
	L	W	T max	A	B	C	Wt.
0805	2.0±0.3	1.25±0.2	0.6	0.3±0.15	0.9 min	0.3±0.1	0.009
1206	3.2±0.4	1.6±0.2	0.7	0.4±0.2	1.7 min	0.4±0.15	0.020
2010	5.1±0.3	2.5±0.2	0.8	0.6±0.3	3.0 min	0.6±0.25	0.036
2512	6.5±0.3	3.2±0.2	0.8	0.6±0.3	4.4 min	0.6±0.25	0.055

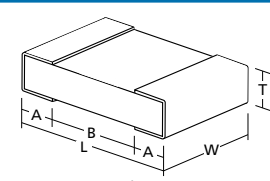

### Construction

Thick film resistor material, overglaze and organic protection are screen printed on a 96% alumina substrate. Wrap-around terminations have an electroplated nickel barrier and solder coating, this ensures excellent 'leach' resistance properties and solderability.

### Marking

Components are not marked. Reels are marked with type, value, tolerance, date code and quantity.

### Solvent Resistance

The body protection is resistant to all normal industrial cleaning solvents suitable for printed circuits.

### General Note

Welwyn Components reserves the right to make changes in product specification without notice or liability. All information is subject to Welwyn's own data and is considered accurate at time of going to print.

## Performance Data

Size		Maximum	Typical
Load at rated power: 1000 hours at 70°C	ΔR%	1	0.25
Shelf life test: 12 months at room temperature	ΔR%	0.1	0.02
Derating from rated power at 70°C		Zero at 155°C	
Overload: 6.25 x rated power for 2 seconds	ΔR%	1	0.1
Dry heat: 1000 hours at 155°C	ΔR%	1	0.2
Long term damp heat	ΔR%	1	0.25
Temperature rapid change	ΔR%	0.25	0.05
Resistance to solder heat	ΔR%	0.25	0.05
Voltage proof	Volts	500	

Note: A 0.01 Ohm addition to be added to the performance of all resistors <10 Ohms.

## Pulse Performance Data

### Lightning Surge

lightning surge resistors are tested in accordance with IEC 60 115-1 using both 1.2/50μs and 10/700μs pulse shapes. 10 pulses are applied. The limit of acceptance is a shift in resistance of less than 1% from the initial value.

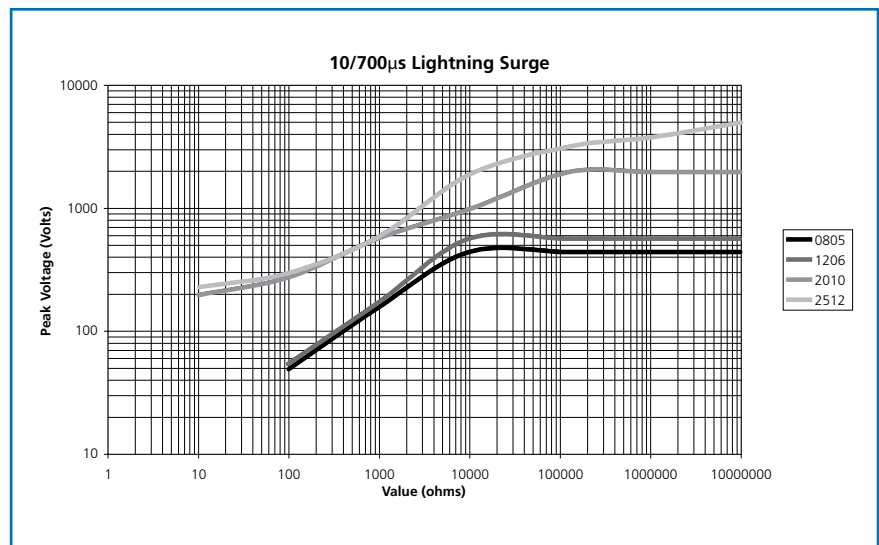
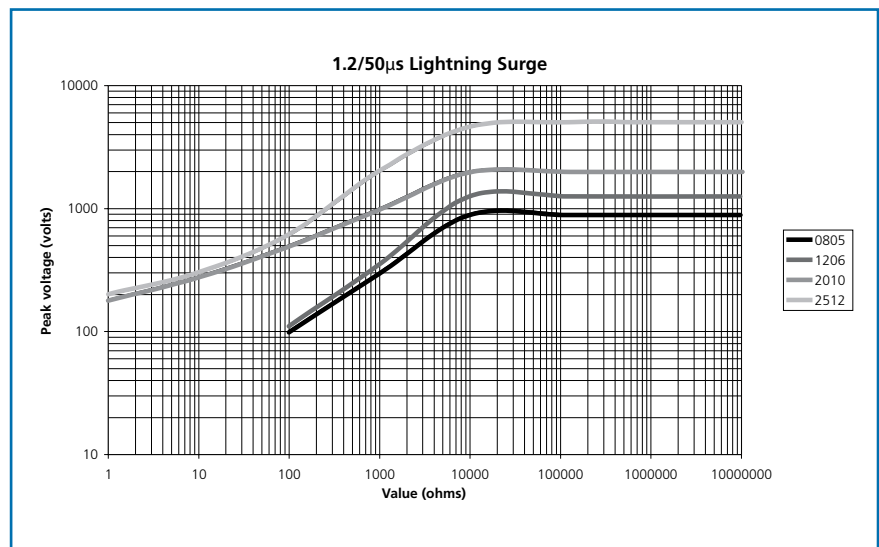

## Pulse Performance Data

### Single Impulse

The single impulse graph is the result of 50 impulses of rectangular shape applied at one minute intervals. The limit of acceptance was a shift in resistance of less than 1% from the initial value.

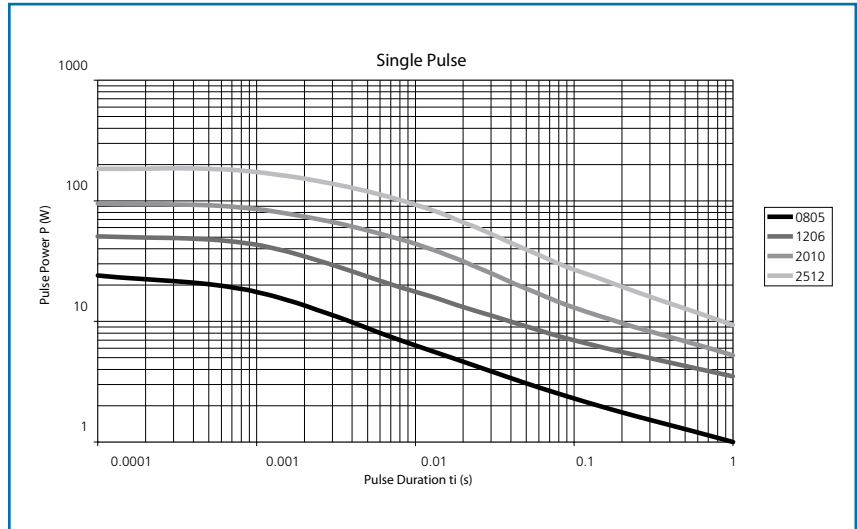

### Continuous Load Due to Repetitive Pulses

The continuous load graph was obtained by applying repetitive rectangular pulses where the pulse period was adjusted so that the average power dissipated in the resistor was equal to its rated power at 70°C. Again the limit of acceptance was a shift in resistance of less than 1% from the initial value.

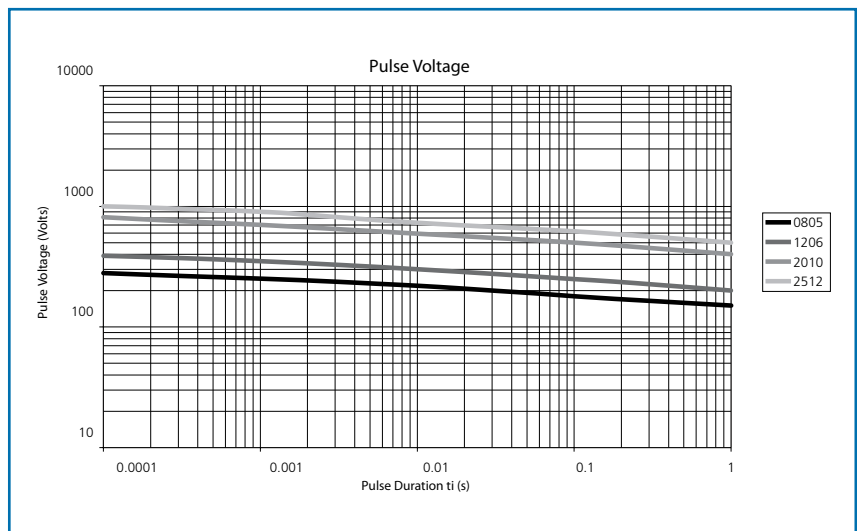
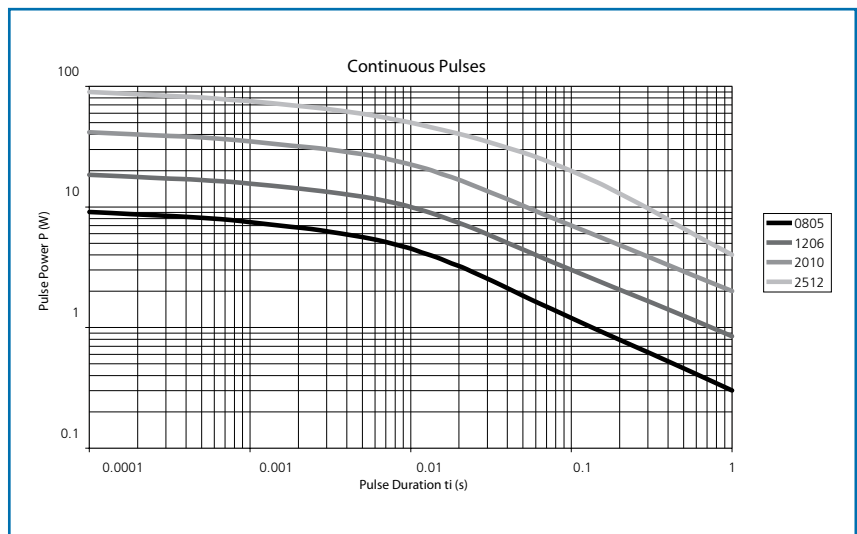

## Thermal Performance Data

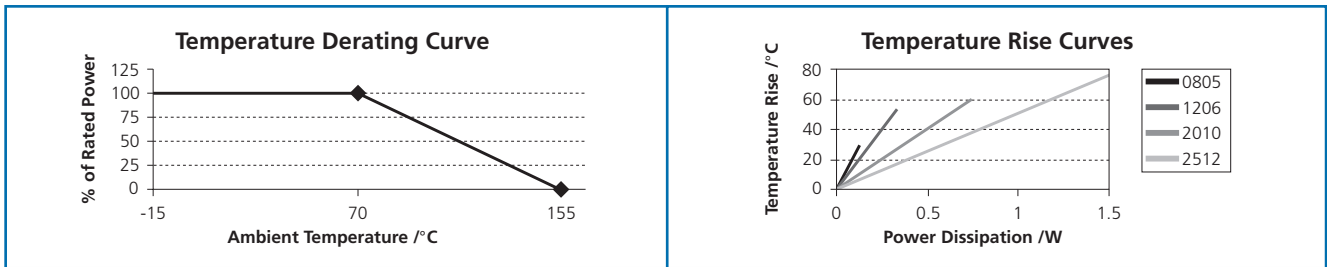

## Packaging

0805 and 1206 PWC series resistors are supplied on 8mm carrier tape and 7 inch reels as per IEC 286-3, quantity per reel; 3000.

2010 and 2512 PWC series resistors are supplied on 12mm carrier tape and 7 inch reels as per IEC 286-3, quantity per reel; 2010 : 3000pcs; 2512 : 1800pcs.

Reels of 1000pcs are available on request.

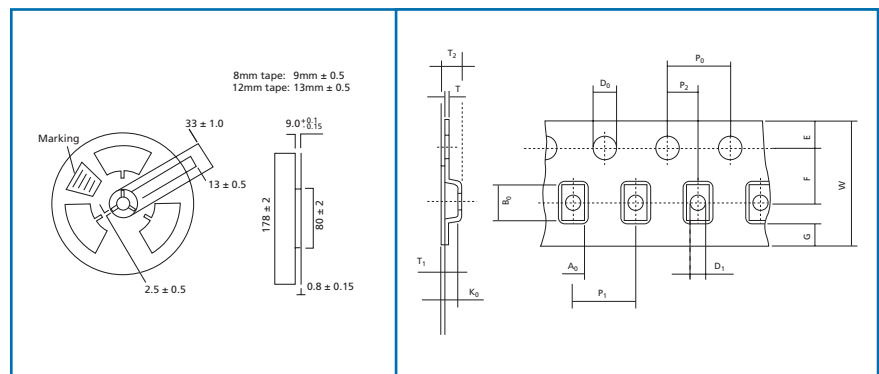

Tape dimensions in mm														
	W	P1	P0	P2	D0	D1	E	F	A0	B0	K0	T	T1	T2
	±0.3	±0.1	±0.1	±0.05	±0.1	±0.2	±0.1	±0.05	±0.1	±0.1	±0.1	±0.05	nom	±0.15
<b>0805</b>	8	4	4	2	1.5	1	1.75	3.5	1.65	2.45	0.8	0.2	0.05	1.1
<b>1206</b>	8	4	4	2	1.5	1	1.75	3.5	1.95	3.55	1.0	0.2	0.05	1.3
<b>2010</b>	12	4	4	2	1.5	1.5	1.75	5.5	2.79	5.89	0.91	0.28	0.06	1.21
<b>2512</b>	12	8	4	2	1.5	1.5	1.75	5.5	3.61	6.96	1.17	0.28	0.06	1.45

## Application Notes

PWC resistors are ideally suited for handling by automatic methods due to their rectangular shape and the small dimensional tolerances. Electrical connection to a ceramic substrate or to a printed circuit board can be made by reflow or wave soldering of wrap-around terminations.

Wrap-around terminations provide good leach properties and ensure reliable contact. Due to the robust construction, the PWC can be immersed in the solder bath for 30 seconds at 260°C. This enables the resistor to be mounted on one side of a printed circuit board and wire-led components applied on the other side.

PWC resistors themselves can operate at a maximum temperature of 155°C. For soldered resistors, the joint temperature should not exceed 110°C. This condition is met when the stated power levels at 70°C and recommended pad

and trace areas are used. Allowance should be made if smaller areas of copper are used.

A full Application Note on the PWC Series is available.

## Ordering Procedure

Specify type reference etc as shown in this example of PWC2512 10K ohms 1%.

Type ..... **PWC**    **2512** - **10K**    **F**

Size .....

Value (use IEC62 code) .....

Tolerance (use IEC62 code) .....

D	0.5%
F	1%
J	5%