

OUTLINE

The R1122N Series are CMOS-based voltage regulator ICs with high output voltage accuracy, extremely low supply current, low ON-resistance and high ripple rejection. Each of these voltage regulator ICs consists of a voltage reference unit, an error amplifier, resistors, a current limit circuit, and a chip enable circuit. These ICs perform with low dropout voltage and a chip enable function.

The line transient response and load transient response of the R1122N Series are excellent, thus these ICs are very suitable for the power supply for hand-held communication equipment. The output voltage of these ICs is fixed with high accuracy.

Since the package for these ICs is SOT-23-5 (Mini-mold) package, high density mounting of the ICs on boards is possible.

FEATURES

- Ultra-Low Supply Current Typ. 100 μ A
- Standby Mode Current..... Typ. 0.1 μ A
- Low Dropout Voltage Typ. 0.19V ($I_{OUT} = 100\text{mA}$, 3V Output type)
- High Ripple Rejection Typ. 80dB ($f = 1\text{kHz}$)
- Low Temperature-Drift Coefficient of Output Voltage..... Typ. $\pm 100\text{ppm}/^{\circ}\text{C}$
- Excellent Line Regulation..... Typ. 0.05%/V
- High Accuracy Output Voltage $\pm 2.0\%$
- Small Package SOT-23-5 (Mini-mold)
- Output Voltage Stepwise setting with a step of 0.1V in the range of 1.5V to 5.0V is possible.
- Built-in chip enable circuit (2 Types; A: active “L”, B: active “H”)
- Built-in Fold-back protection circuit..... Short Current Typ. 30mA
- Pinout..... Similar to the TK112, TK111
- Ceramic Capacitors are Recommendable to be used with this IC.

APPLICATIONS

- Power source for cellular phones such as GSM, CDMA, PCS and so forth.
- Power source for domestic appliances such as cameras, VCRs and camcorders.
- Power source for battery-powered equipment.

BLOCK DIAGRAM

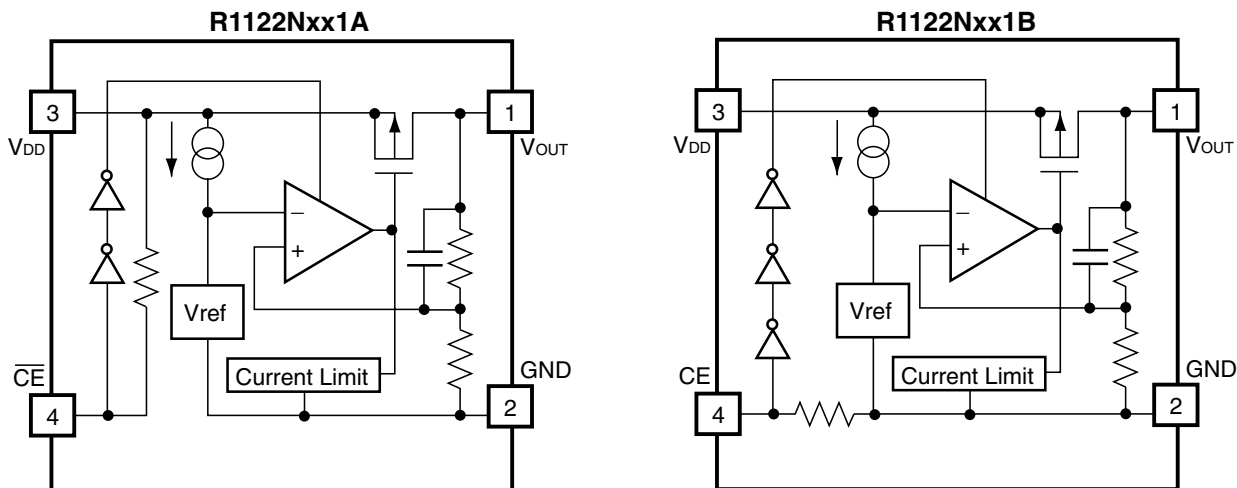

SELECTION GUIDE

The output voltage, the active type, the packing type, and the taping type for the ICs can be selected at the user's request.

The selection can be made by designating the part number as shown below :

R1122Nxx1x-xx ←Part Number
 ↑ ↑ ↑
 a b c

Code	Contents
a	Setting Output Voltage (V_{OUT}): Stepwise setting with a step of 0.1V in the range of 1.5V to 5.0V is possible.
b	Designation of Active Type: A: active "L" type B: active "H" type
c	Designation of Taping Type: Ex. TR, TL (refer to Taping Specifications; TR type is the standard direction.)

PIN CONFIGURATION

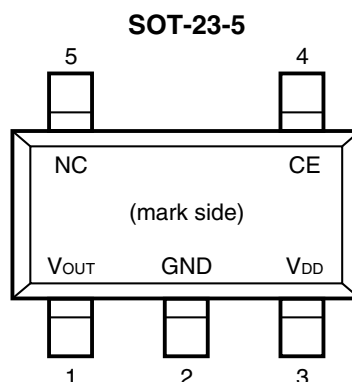

PIN DESCRIPTION

Pin No.	Symbol	Description
1	V_{OUT}	Output pin
2	GND	Ground Pin
3	V_{DD}	Input Pin
4	\overline{CE} or CE	Chip Enable Pin
5	NC	No Connection

ABSOLUTE MAXIMUM RATINGS

Symbol	Item	Rating	Unit
V_{IN}	Input Voltage	7.0	V
V_{CE}	Input Voltage (CE or \overline{CE} Pin)	-0.3 ~ $V_{IN}+0.3$	V
V_{OUT}	Output Voltage	-0.3 ~ $V_{IN}+0.3$	V
I_{OUT}	Output Current	200	mA
P_D	Power Dissipation	250	mW
T_{opt}	Operating Temperature Range	-40 ~ 85	°C
T_{stg}	Storage Temperature Range	-55 ~ 125	°C

ELECTRICAL CHARACTERISTICS

• R1122Nxx1A

T_{opt} = 25°C

Symbol	Item	Conditions	Min.	Typ.	Max.	Unit
V _{OUT}	Output Voltage	V _{IN} = Set V _{OUT} +1V 1mA ≤ I _{OUT} ≤ 30mA	V _{OUT} ×0.98		V _{OUT} ×1.02	V
I _{OUT}	Output Current	V _{IN} = Set V _{OUT} +1V When V _{OUT} = Set V _{OUT} -0.1V	150			mA
ΔV _{OUT} /ΔI _{OUT}	Load Regulation	V _{IN} = Set V _{OUT} +1V 1mA ≤ I _{OUT} ≤ 80mA		12	40	mV
V _{DIF}	Dropout Voltage	refer to the ELECTRICAL CHARACTERISTICS by OUTPUT VOLTAGE				
I _{SS}	Supply Current	V _{IN} = Set V _{OUT} +1V		100	170	μA
I _{standby}	Supply Current (Standby)	V _{IN} = V _{CE} = Set V _{OUT} +1V		0.1	1.0	μA
ΔV _{OUT} /ΔV _{IN}	Line Regulation	Set V _{OUT} +0.5V ≤ V _{IN} ≤ 6V I _{OUT} = 30mA		0.05	0.20	%/V
RR	Ripple Rejection	f = 1kHz, Ripple 0.5Vp-p V _{IN} = Set V _{OUT} +1V		80		dB
V _{IN}	Input Voltage		2.0		6.0	V
ΔV _{OUT} /ΔT	Output Voltage Temperature Coefficient	I _{OUT} = 30mA -40°C ≤ T _{opt} ≤ 85°C		±100		ppm /°C
I _{lim}	Short Current Limit	V _{OUT} = 0V		30		mA
R _{PU}	$\overline{\text{CE}}$ Pull-up Resistance		2.5	5.0	10.0	MΩ
V _{CEH}	$\overline{\text{CE}}$ Input Voltage "H"		1.5		V _{IN}	V
V _{CEL}	$\overline{\text{CE}}$ Input Voltage "L"		0.00		0.25	V
e _n	Output Noise	BW = 10Hz ~ 100kHz		30		μVrms

• R1122Nxx1B

T_{opt}=25°C

Symbol	Item	Conditions	Min.	Typ.	Max.	Unit
V _{OUT}	Output Voltage	V _{IN} = Set V _{OUT} +1V 1mA ≤ I _{OUT} ≤ 30mA	V _{OUT} ×0.98		V _{OUT} ×1.02	V
I _{OUT}	Output Current	V _{IN} = Set V _{OUT} +1V When V _{OUT} = Set V _{OUT} -0.1V	150			mA
ΔV _{OUT} /ΔI _{OUT}	Load Regulation	V _{IN} = Set V _{OUT} +1V 1mA ≤ I _{OUT} ≤ 80mA		12	40	mV
V _{DIF}	Dropout Voltage	refer to the ELECTRICAL CHARACTERISTICS by OUTPUT VOLTAGE				
I _{SS}	Supply Current	V _{IN} = Set V _{OUT} +1V		100	170	μA
I _{standby}	Supply Current (Standby)	V _{IN} = Set V _{OUT} +1V V _{CE} = GND		0.1	1.0	μA
ΔV _{OUT} /ΔV _{IN}	Line Regulation	Set V _{OUT} +0.5V ≤ V _{IN} ≤ 6V I _{OUT} = 30mA		0.05	0.20	%/V
RR	Ripple Rejection	f = 1kHz, Ripple 0.5Vp-p V _{IN} = Set V _{OUT} +1V		80		dB
V _{IN}	Input Voltage		2.0		6.0	V
ΔV _{OUT} /ΔT	Output Voltage Temperature Coefficient	I _{OUT} = 30mA -40°C ≤ T _{opt} ≤ 85°C		±100		ppm /°C
I _{lim}	Short Current Limit	V _{OUT} = 0V		30		mA
R _{PD}	CE Pull-down Resistance		2.5	5.0	10.0	MΩ
V _{CEH}	CE Input Voltage "H"		1.5		V _{IN}	V
V _{CEL}	CE Input Voltage "L"		0.00		0.25	V
en	Output Noise	BW = 10Hz ~ 100kHz		30		μVrms

• ELECTRICAL CHARACTERISTICS by OUTPUT VOLTAGE

T_{opt} = 25°C

Output Voltage V _{OUT} (V)	Dropout Voltage		
	V _{DIF} (V)		
	Conditions	Typ.	Max.
1.5 ≤ V _{OUT} ≤ 1.6	I _{OUT} = 100mA	0.32	0.55
1.7 ≤ V _{OUT} ≤ 1.8		0.28	0.47
1.9 ≤ V _{OUT} ≤ 2.3		0.25	0.35
2.4 ≤ V _{OUT} ≤ 2.7		0.20	0.29
2.8 ≤ V _{OUT} ≤ 5.0		0.19	0.26

OPERATION

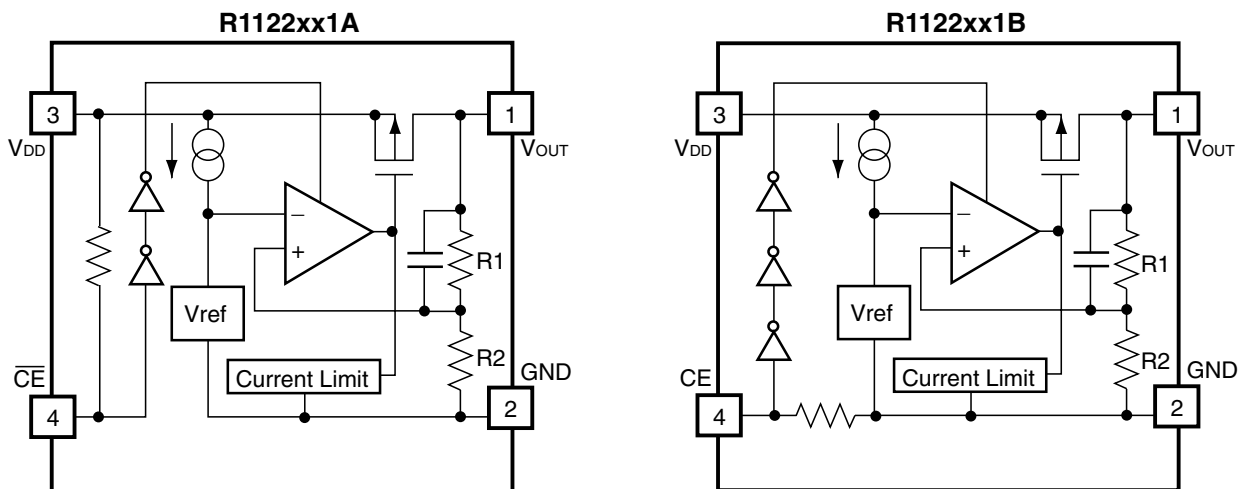

In these ICs, fluctuation of the output voltage, V_{OUT} is detected by feed-back registers, R₁ and R₂, and the result is compared with a reference voltage by the error amplifier, so that a constant voltage is output.

A current limit circuit for protection at short mode, and a chip enable circuit, are included.

TEST CIRCUITS

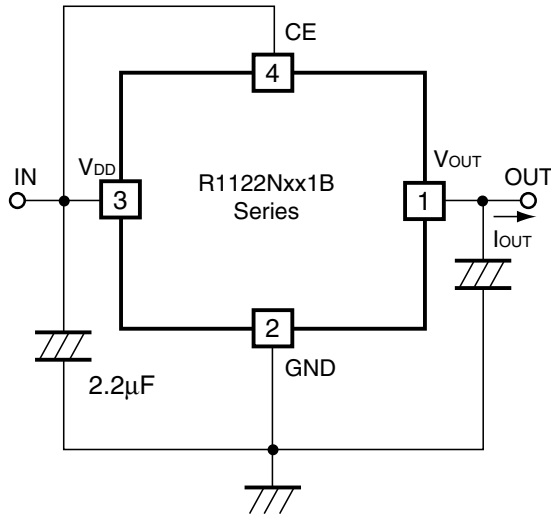

Fig.1 Standard test Circuit

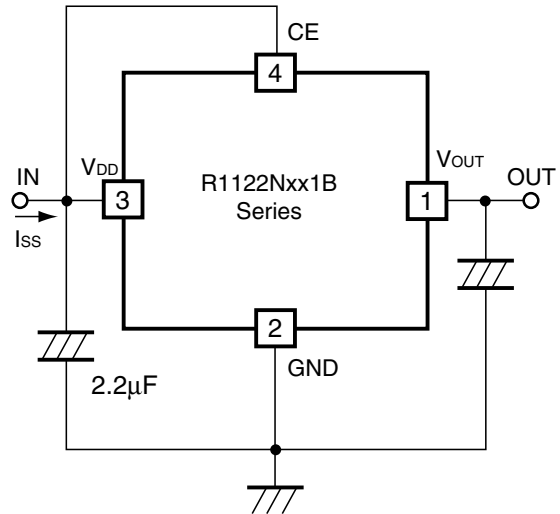

Fig.2 Supply Current Test Circuit

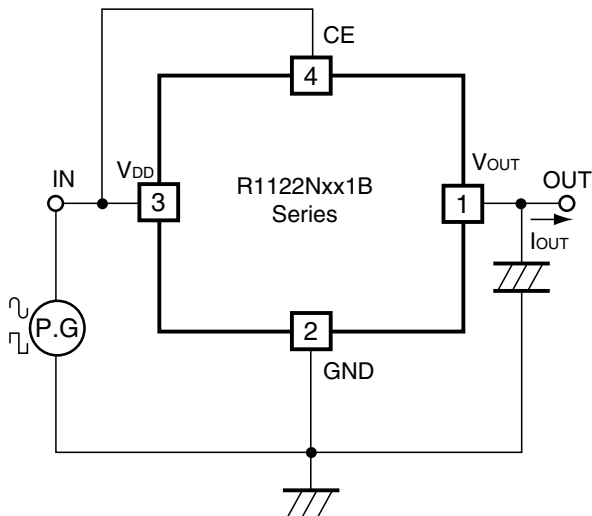

Fig.3 Ripple Rejection, Line Transient Response Test Circuit

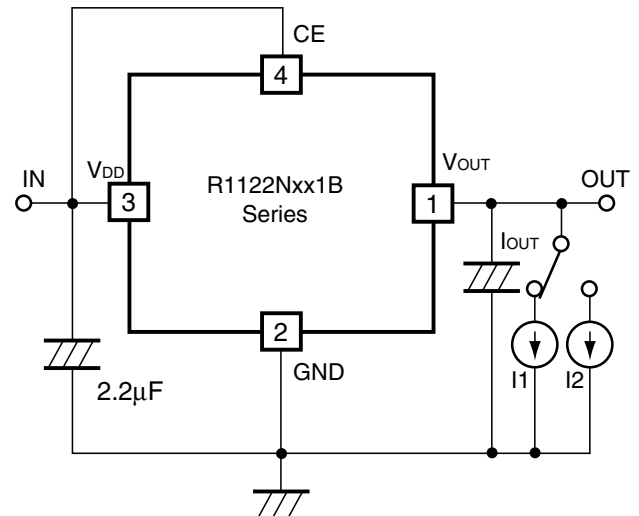

Fig.4 Load Transient Response Test Circuit

TECHNICAL NOTES

When using these ICs, consider the following points:

Phase Compensation

In these ICs, phase compensation is made for securing stable operation even if the load current is varied. For this purpose, be sure to use a capacitor C_{OUT} with good frequency characteristics and ESR (Equivalent Series Resistance). (Note: When the additional ceramic capacitors are connected to the output pin with the output capacitor for phase compensation, the operation might be unstable. Because of this, test these ICs with the same external components as the ones to be used on the PCB.)

Recommended Capacitors; GRM40X5R225K6.3 (Murata)

GRM40-034X5R335K6.3 (Murata)

GRM40-034X5R475K6.3 (Murata)

PCB Layout

Make V_{DD} and GND lines sufficient. If their impedance is high, picking up the noise or unstable operation may result. Connect a capacitor with a capacitance of $2.2\mu\text{F}$ or more between V_{DD} and GND pin as close as possible.

Set external components, especially output capacitor as close as possible to the ICs and make wiring as short as possible.

TYPICAL APPLICATION

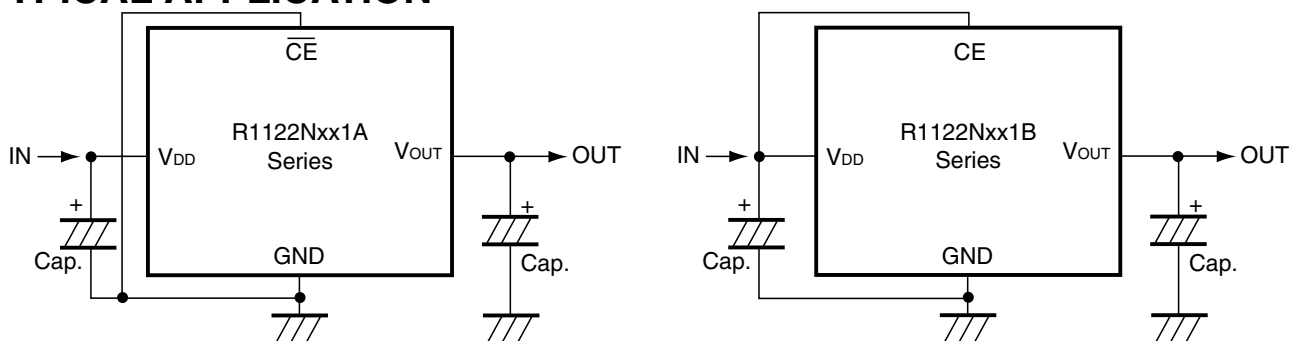

(External Components)

Output Capacitor; Ceramic $2.2\mu\text{F}$ (Set output voltage in the range from 2.5 to 5.0V)

Ceramic $4.7\mu\text{F}$ (Set output voltage in the range from 1.5 to 2.5V)

Input Capacitor; Ceramic $2.2\mu\text{F}$

TYPICAL CHARACTERISTICS

1) Output Voltage vs. Output Current

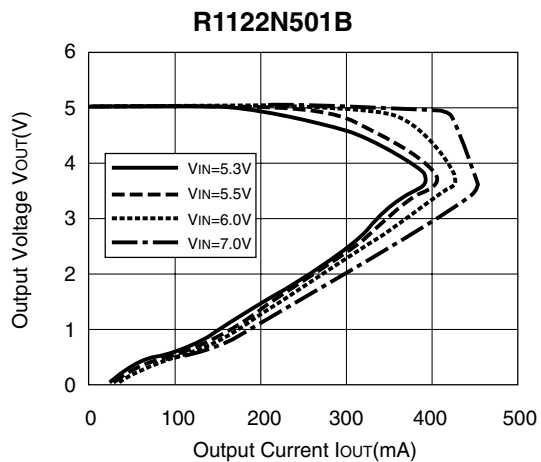
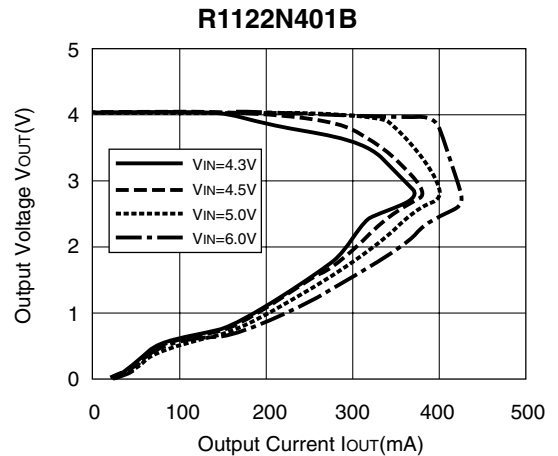
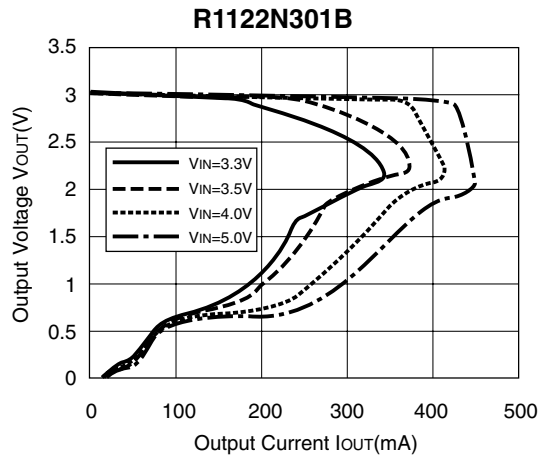
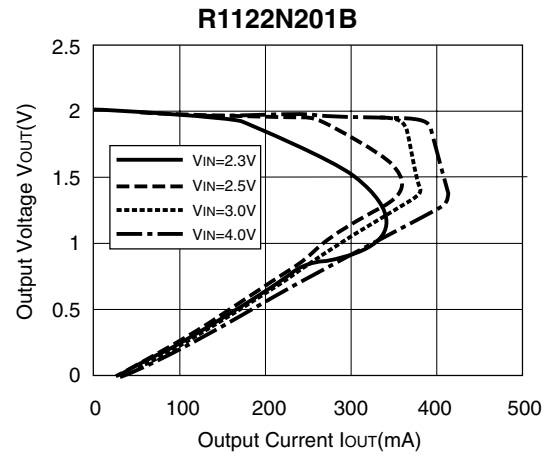
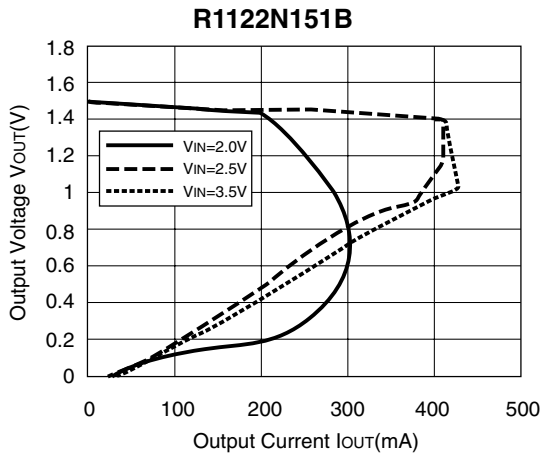

2) Output Voltage vs. Input Voltage

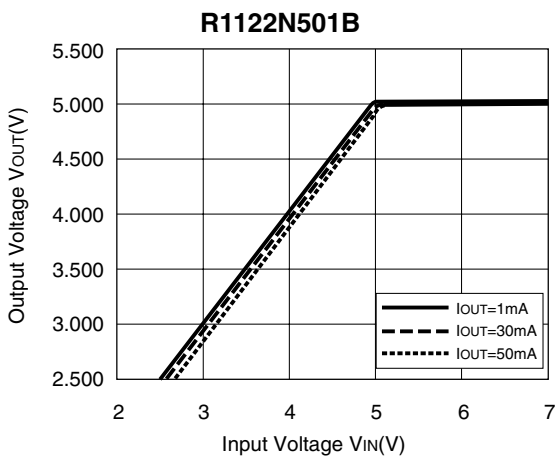
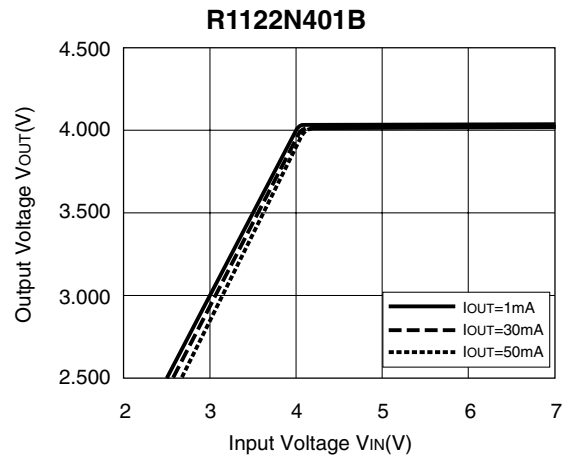
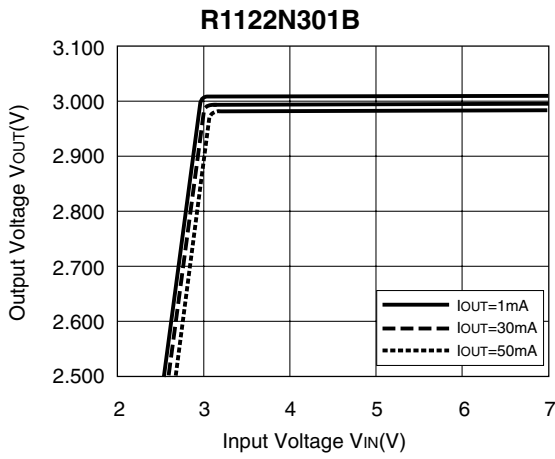
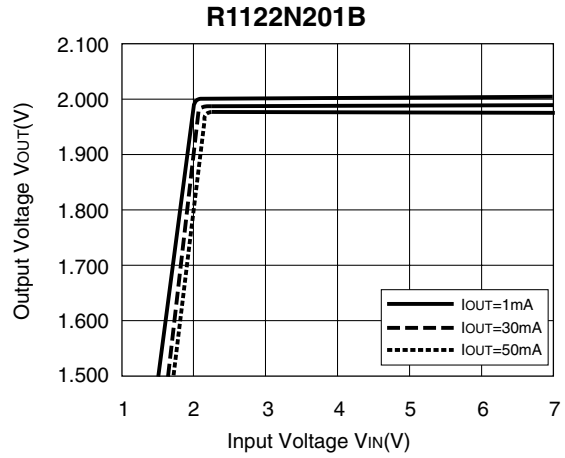
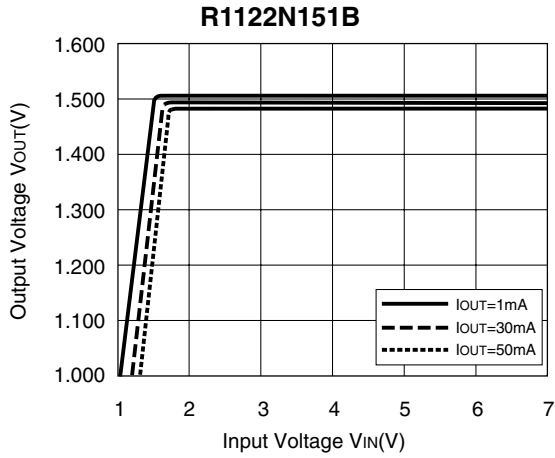

3) Dropout Voltage vs. Output Current

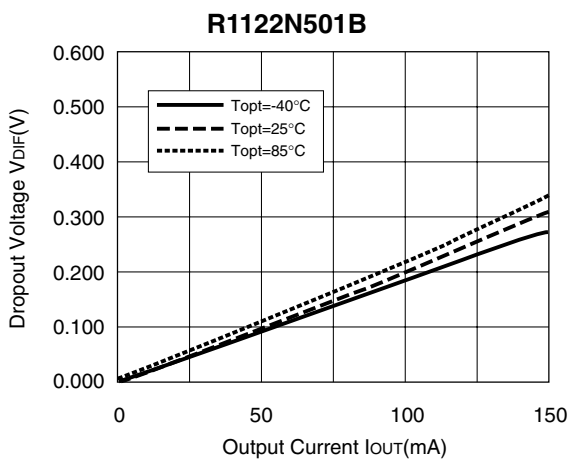
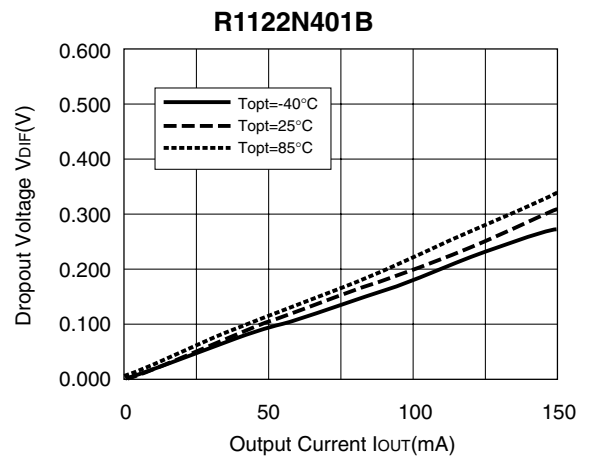
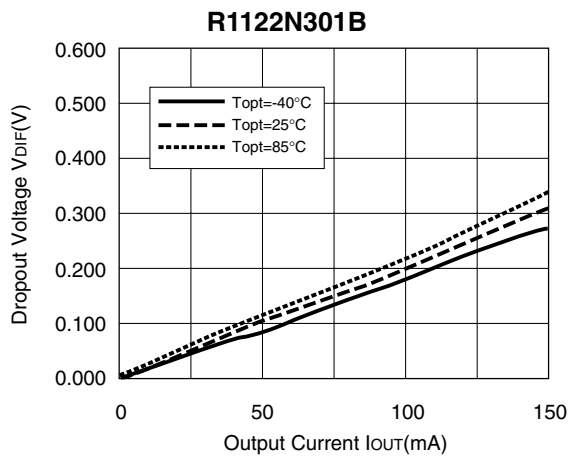
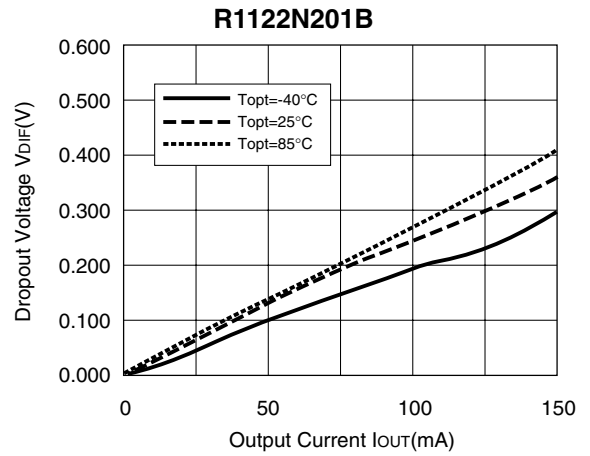
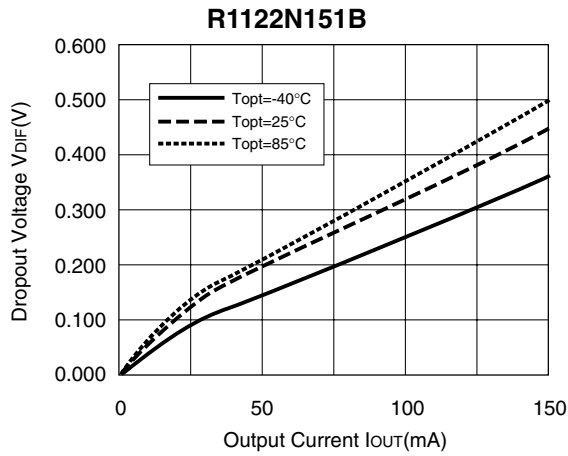

4) Output Voltage vs. Temperature

R1122N151A/B

$V_{IN}=2.5V$ $C_{IN}=1\mu F$
 $C_{OUT}=2.2\mu F$ $I_{OUT}=30mA$

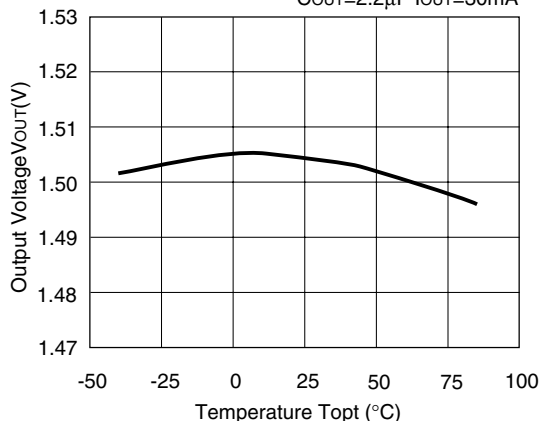

R1122N201B

$V_{IN}=3.0V$ $C_{IN}=1\mu F$
 $C_{OUT}=2.2\mu F$ $I_{OUT}=30mA$

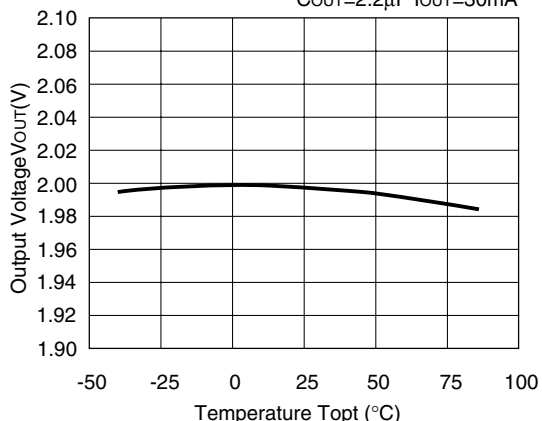

R1122N301A/B

$V_{IN}=4.0V$ $C_{IN}=1\mu F$
 $C_{OUT}=2.2\mu F$ $I_{OUT}=30mA$

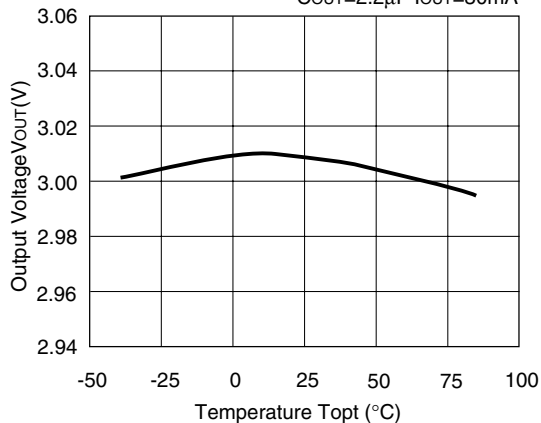

R1122N401A/B

$V_{IN}=5.0V$ $C_{IN}=1\mu F$
 $C_{OUT}=2.2\mu F$ $I_{OUT}=30mA$

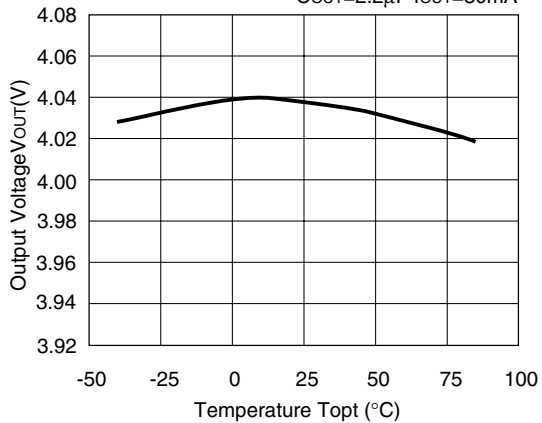

R1122N501A/B

$V_{IN}=6.0V$ $C_{IN}=1\mu F$
 $C_{OUT}=2.2\mu F$ $I_{OUT}=30mA$

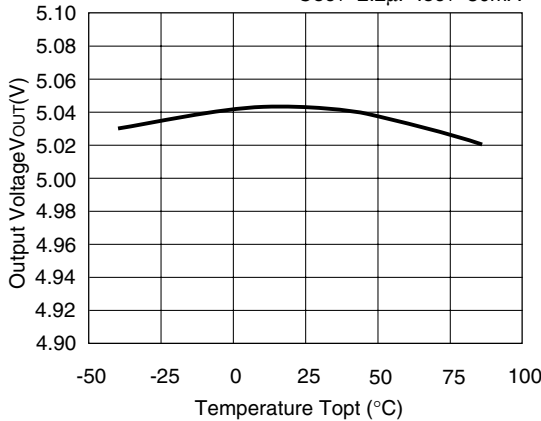

5) Supply Current vs. Input Voltage

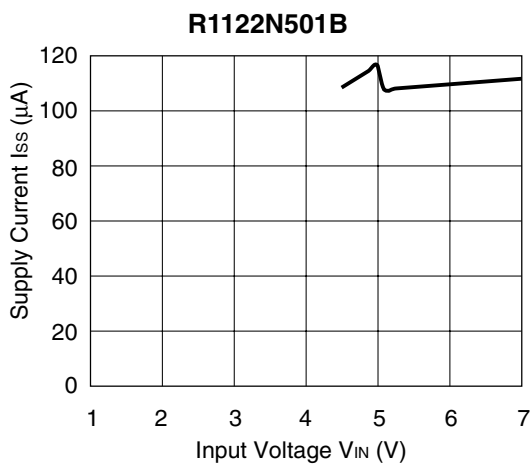
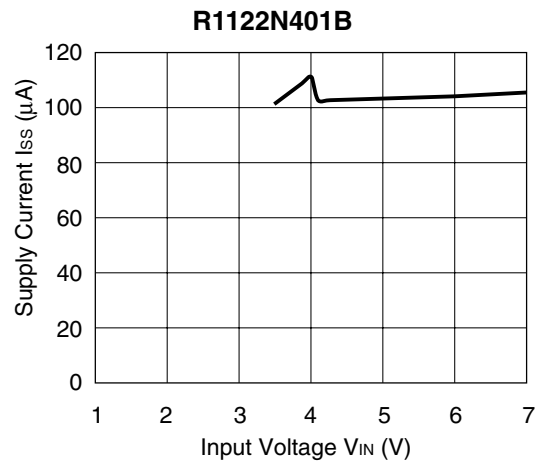
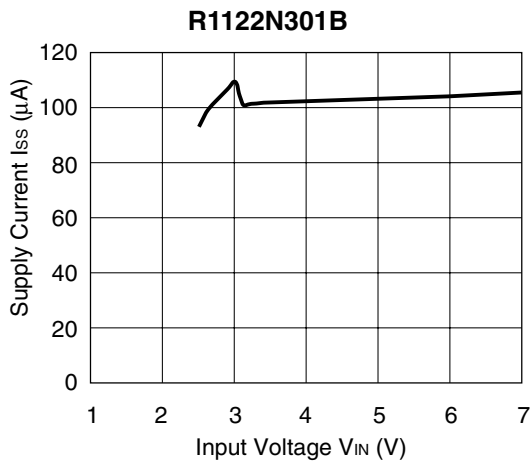
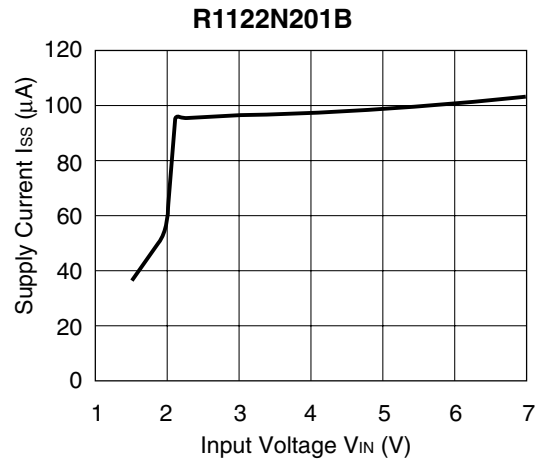
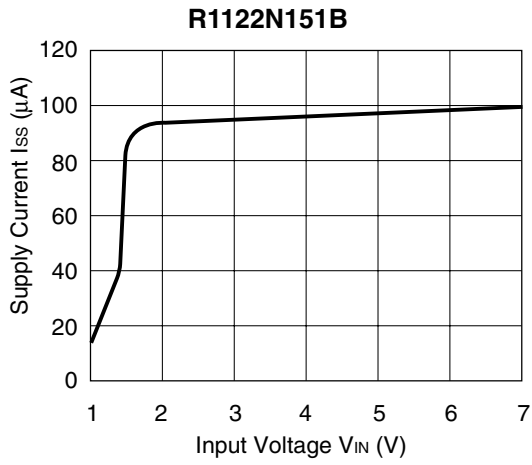

6) Supply Current vs. Temperature

R1122N151A/B

$V_{IN}=2.5V$ $C_{IN}=1\mu F$
 $C_{OUT}=2.2\mu F$

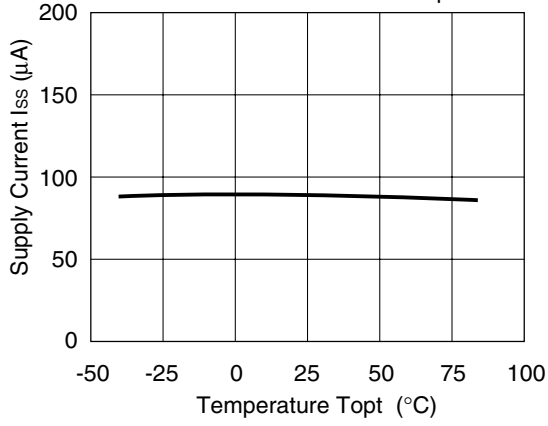

R1122N201A/B

$V_{IN}=3.0V$ $C_{IN}=1\mu F$
 $C_{OUT}=2.2\mu F$

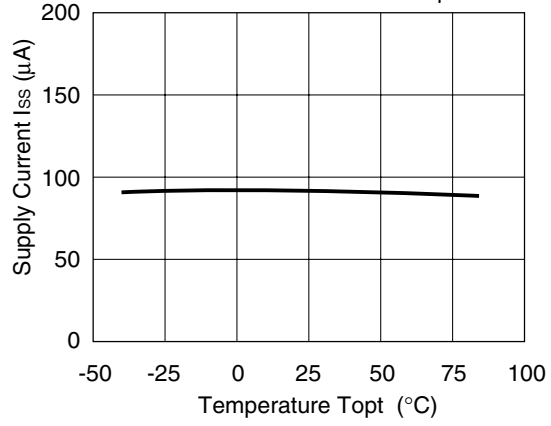

R1122N301A/B

$V_{IN}=4.0V$ $C_{IN}=1\mu F$
 $C_{OUT}=2.2\mu F$

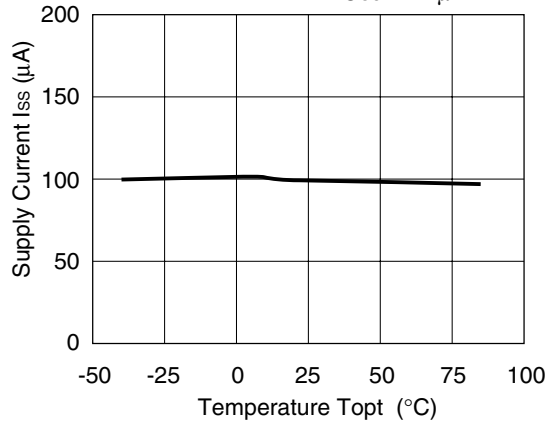

R1122N401A/B

$V_{IN}=5.0V$ $C_{IN}=1\mu F$
 $C_{OUT}=2.2\mu F$

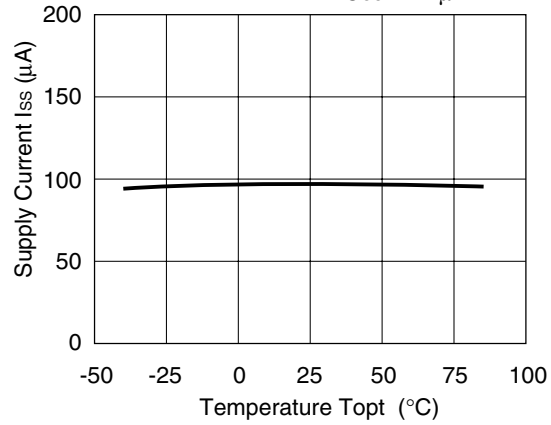

R1122N501A/B

$V_{IN}=6.0V$ $C_{IN}=1\mu F$
 $C_{OUT}=2.2\mu F$

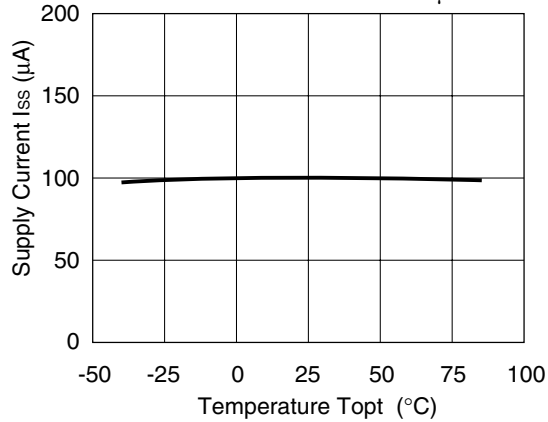

7) Ripple Rejection vs. Frequency

R1122N151A/B

$V_{IN}=2.5V+0.5Vp-p$
 $C_{OUT}=2.2\mu F$ $I_{OUT}=30mA$

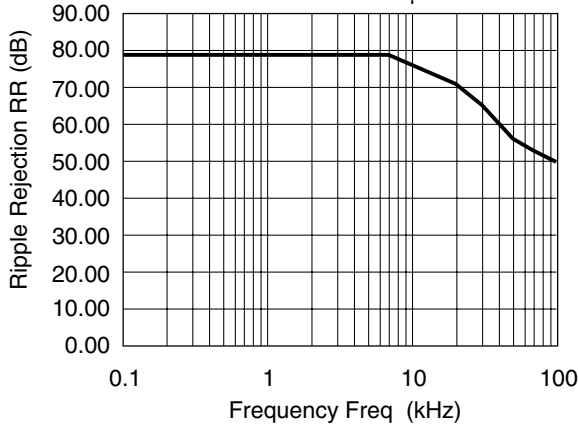

R1122N201A/B

$V_{IN}=3.0V+0.5Vp-p$
 $C_{OUT}=2.2\mu F$ $I_{OUT}=30mA$

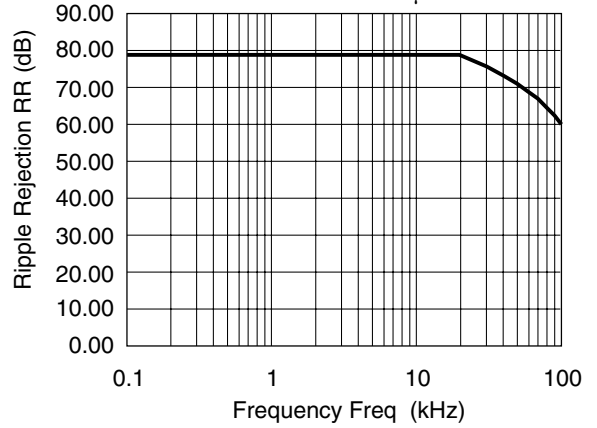

R1122N301A/B

$V_{IN}=4.0V+0.5Vp-p$
 $C_{OUT}=2.2\mu F$ $I_{OUT}=30mA$

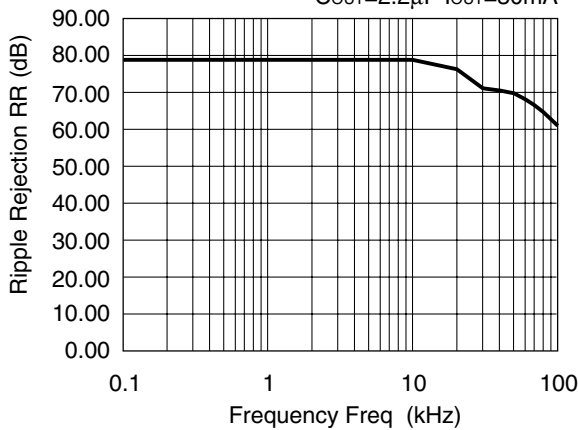

R1122N401A/B

$V_{IN}=5.0V+0.5Vp-p$
 $C_{OUT}=2.2\mu F$ $I_{OUT}=30mA$

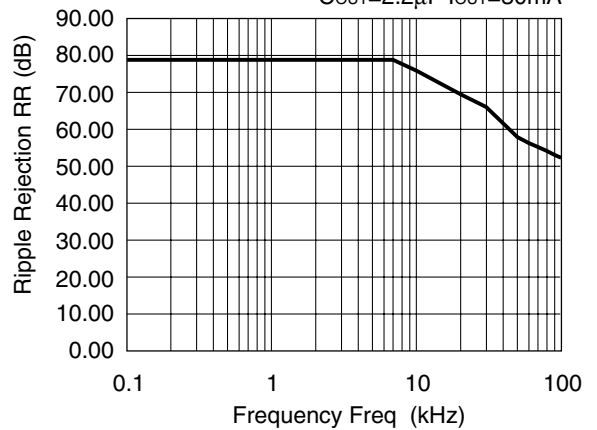

R1122N501A/B

$V_{IN}=6.0V+0.5Vp-p$
 $C_{OUT}=2.2\mu F$ $I_{OUT}=30mA$

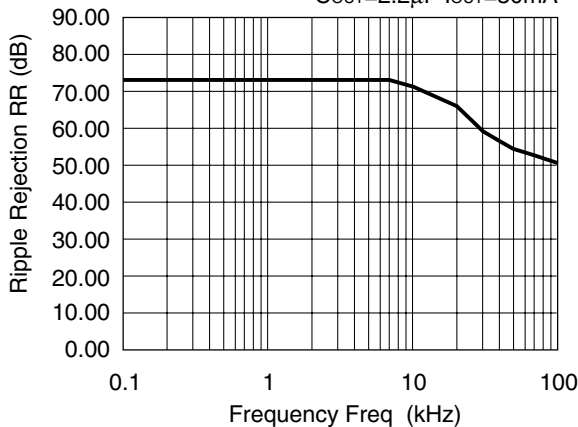

8) Ripple Rejection vs. Input Voltage (DC bias)

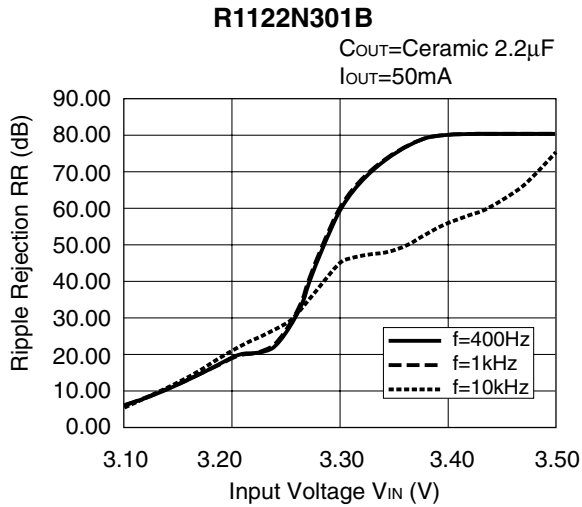
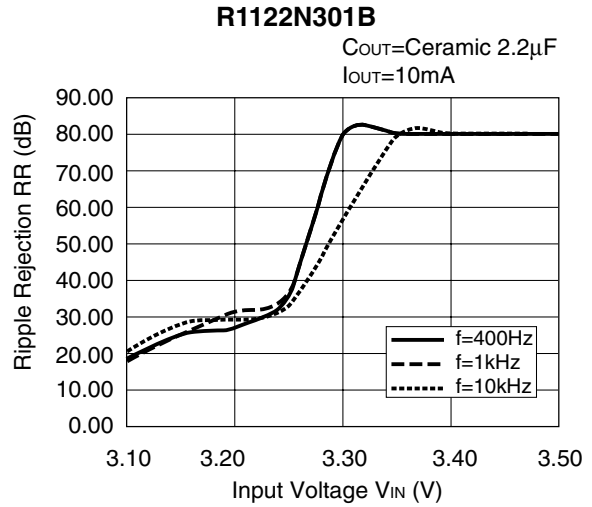
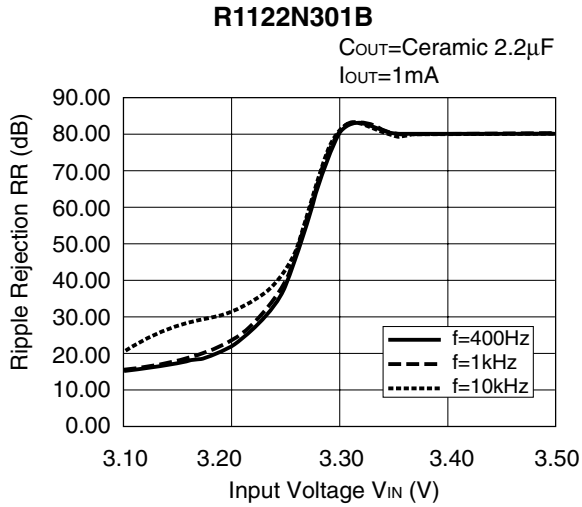

9) Input Transient Response

R1122N151B

T_{opt} =25°C

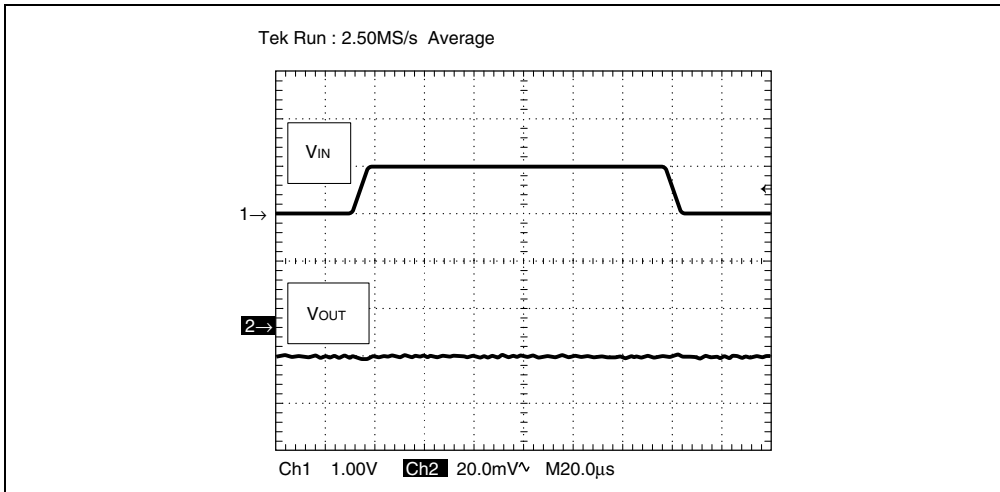

V_{IN} =2.5V \leftrightarrow 3.5V
 I_{OUT} =30mA
 C_{IN} =none
 C_{OUT} =2.2 μ F
 t_r/t_f =5 μ s

R1122N201B

$T_{opt}=25^{\circ}\text{C}$

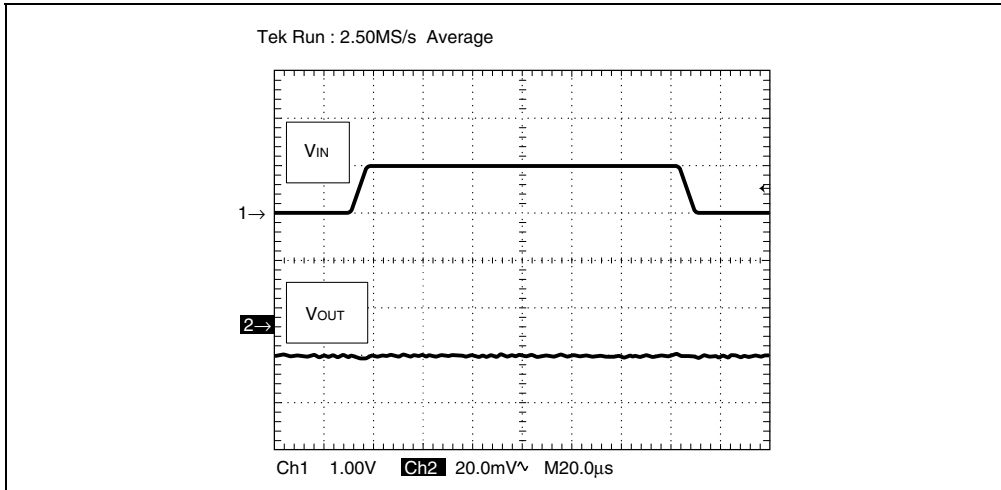

$V_{IN}=3.0\text{V}\leftrightarrow 4.0\text{V}$
 $I_{OUT}=30\text{mA}$
 $C_{IN}=\text{none}$
 $C_{OUT}=2.2\mu\text{F}$
 $t_r/t_f=5\mu\text{s}$

R1122N301B

$T_{opt}=25^{\circ}\text{C}$

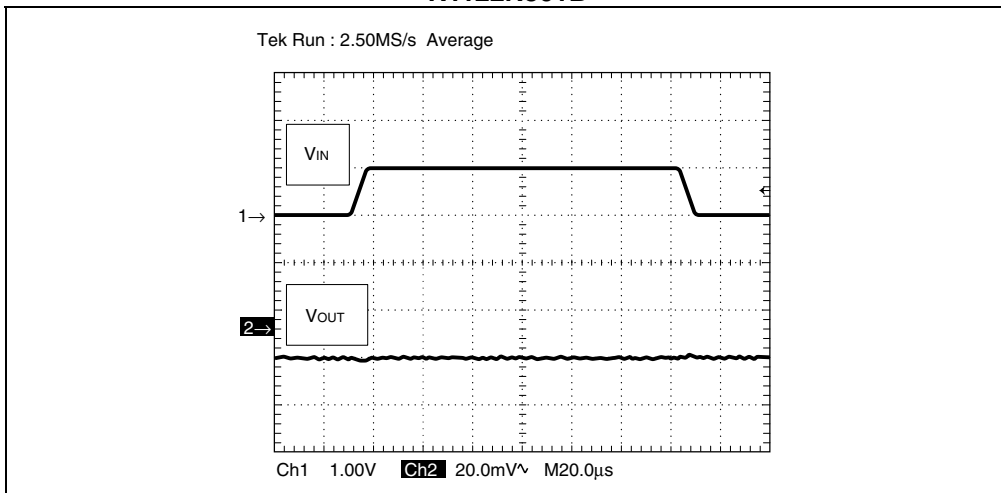

$V_{IN}=4.0\text{V}\leftrightarrow 5.0\text{V}$
 $I_{OUT}=30\text{mA}$
 $C_{IN}=\text{none}$
 $C_{OUT}=2.2\mu\text{F}$
 $t_r/t_f=5\mu\text{s}$

R1122N401B

$T_{opt}=25^{\circ}\text{C}$

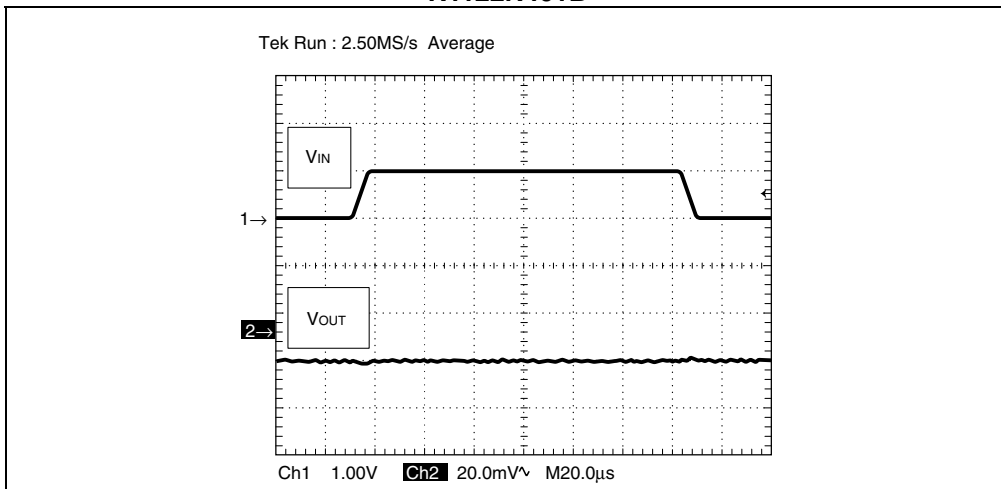

$V_{IN}=5.0\text{V}\leftrightarrow 6.0\text{V}$
 $I_{OUT}=30\text{mA}$
 $C_{IN}=\text{none}$
 $C_{OUT}=2.2\mu\text{F}$
 $t_r/t_f=5\mu\text{s}$

R1122N501B

Topt=25°C

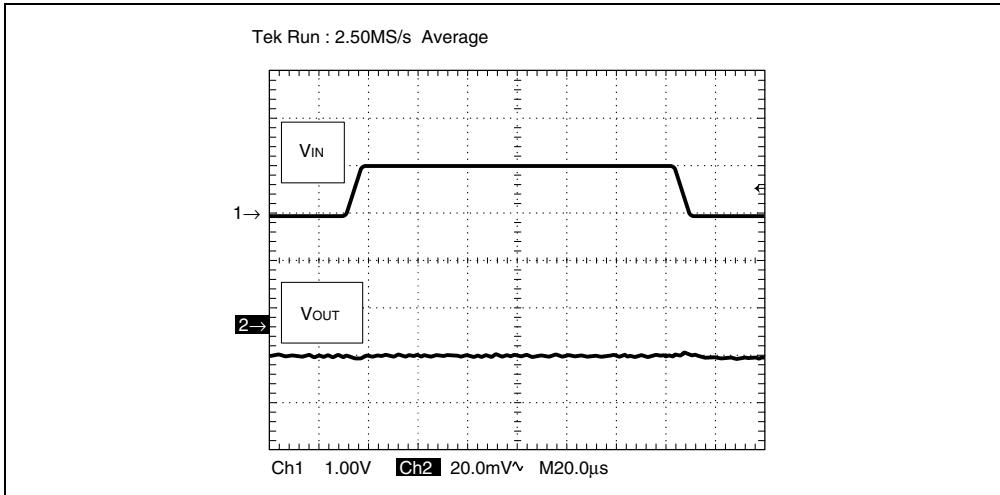

$V_{IN}=6.0V \leftrightarrow 7.0V$
 $I_{OUT}=30mA$
 $C_{IN}=none$
 $C_{OUT}=2.2\mu F$
 $tr/tf=5\mu s$

10) Load Transient Response

R1122N151B

Topt=25°C

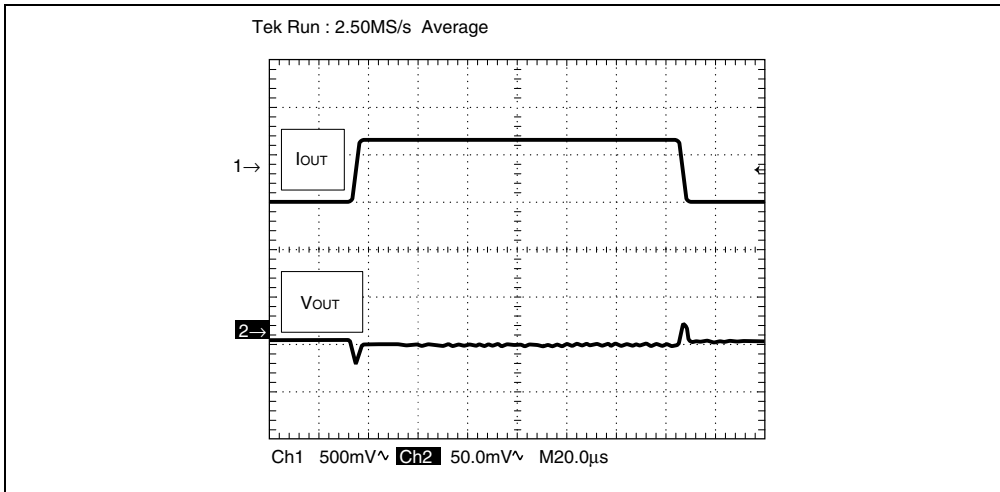

$I_{OUT}=50mA \leftrightarrow 100mA$
 $V_{IN}=2.5V$
 $C_{IN}=2.2\mu F$
 $C_{OUT}=2.2\mu F$
 $tr/tf=5\mu s$

R1122N201B

Topt=25°C

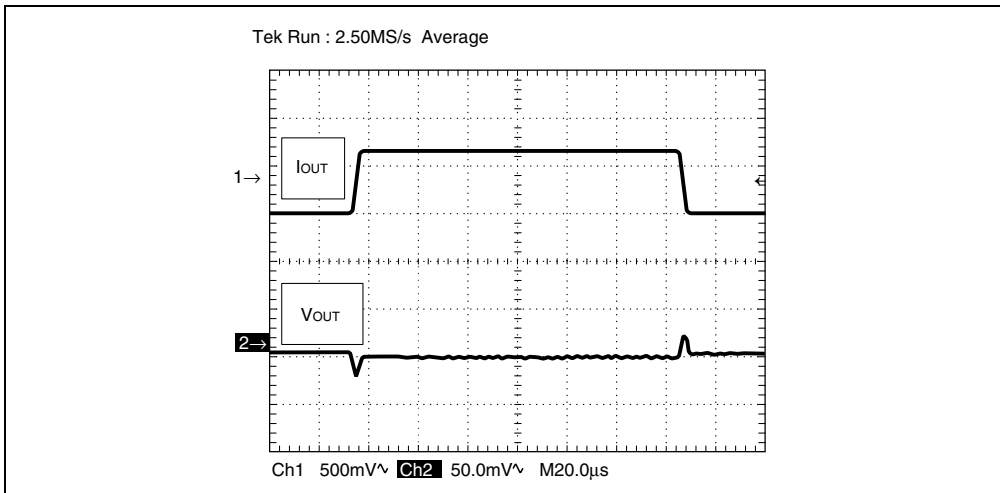

$I_{OUT}=50mA \leftrightarrow 100mA$
 $V_{IN}=3.0V$
 $C_{IN}=2.2\mu F$
 $C_{OUT}=2.2\mu F$
 $tr/tf=5\mu s$

R1122N301B

$T_{opt}=25^{\circ}C$

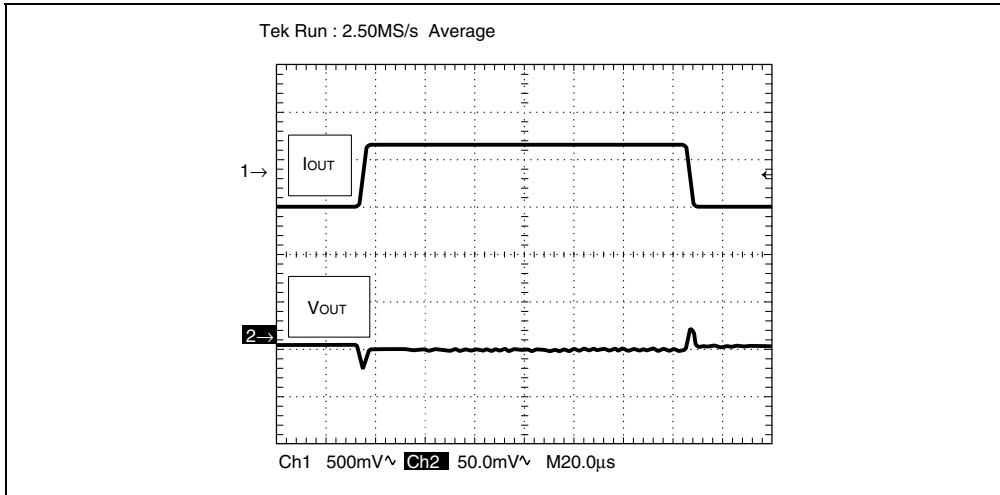

$I_{OUT}=50mA \leftrightarrow 100mA$
 $V_{IN}=4.0V$
 $C_{IN}=2.2\mu F$
 $C_{OUT}=2.2\mu F$
 $t_r/t_f=5\mu s$

R1122N401B

$T_{opt}=25^{\circ}C$

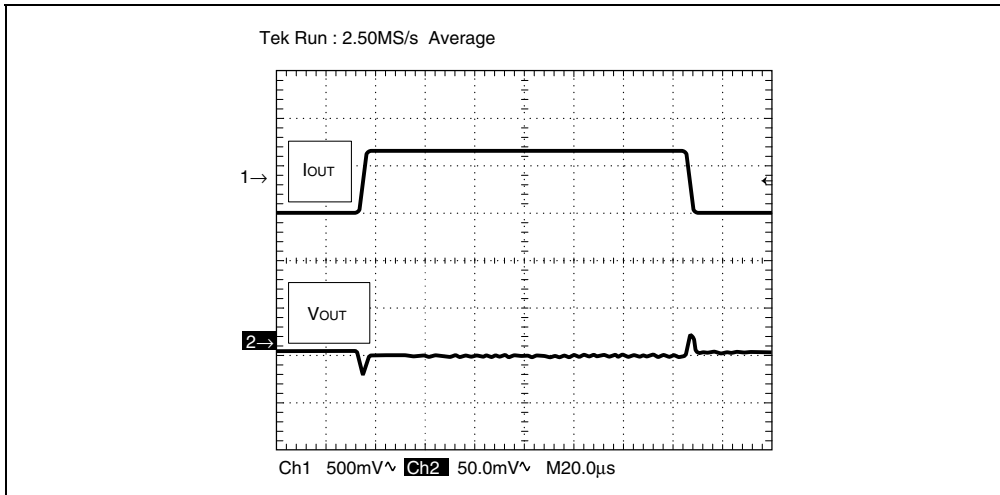

$I_{OUT}=50mA \leftrightarrow 100mA$
 $V_{IN}=5.0V$
 $C_{IN}=2.2\mu F$
 $C_{OUT}=2.2\mu F$
 $t_r/t_f=5\mu s$

R1122N501B

$T_{opt}=25^{\circ}C$

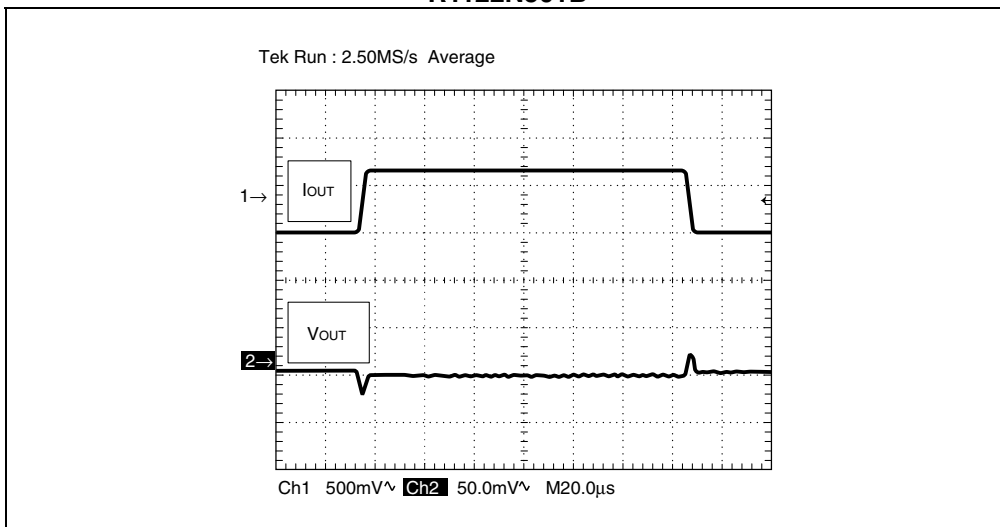

$I_{OUT}=50mA \leftrightarrow 100mA$
 $V_{IN}=6.0V$
 $C_{IN}=2.2\mu F$
 $C_{OUT}=2.2\mu F$
 $t_r/t_f=5\mu s$

TECHNICAL NOTES

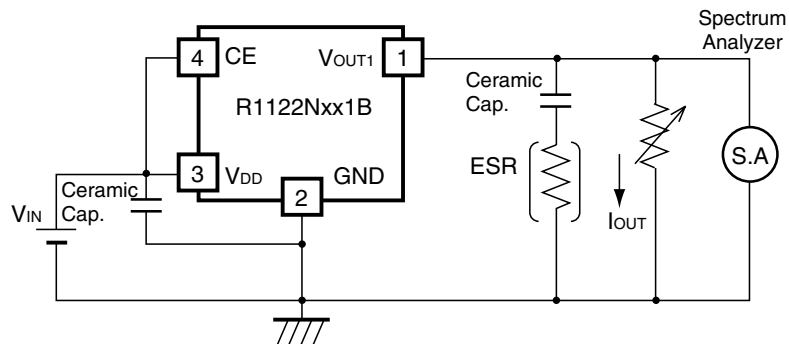

Measuring Circuit for white noise; R1122Nxx1B

The relationship between I_{OUT} (Output Current) and ESR of the output capacitor is shown below. The conditions when the white noise level is under $40\mu V$ (Avg.) are indicated the hatched area in the graph.

(note: When the additional ceramic capacitors are connected to the output pin with output capacitor for phase compensation, the operation might be unstable. Because of this, test these ICs with as the same external components as the ones to be used on the PCB.)

<measuring conditions>

- (1) $V_{IN} = V_{OUT} + 1V$
- (2) Frequency band: 10Hz to 1MHz
- (3) Temperature: $25^{\circ}C$