

FEATURES

- Ultra Low ESR and High Ripple Current Ratings
- Values from 2.2 μ F to 680 μ F
- Suitable for Reflow Soldering
- Available in EIA J, P, A2, A, B2, B, C, V and D Case Sizes

EXPANDED RANGE OF VALUES
(SEE RIPPLE CURRENT RATINGS TABLE FOR DETAILS)

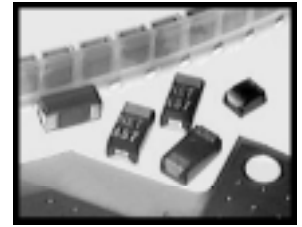

Low ESR Component
Polymer Cathode Tantalum
For Performance Data
See www.LowESR.com

CHARACTERISTICS

Capacitance Range	2.2 μ F to 680 μ F	
Capacitance Tolerance	\pm 20% (M)	
Rated Working Voltage	2.5Vdc to 16Vdc*	
Operating Temperature Range	-55°C ~ +105°C (derating above 85°C)	
Dissipation Factor (120Hz/20°C)	See specifications table	
Leakage Current Rating (after 5 minutes)	0.1CV or 3 μ A whichever is greater	
Capacitance Change Verse Temperature	-55°C	+105°C
	Δ C - 20%	Δ C + 50%
Soldering Heat Resistance (+240°C for 5 ~ 10 sec.)	Δ Capacitance: \pm 20% Leakage Current: 130% of initial value Dissipation Factor: less than value in specifications table.	
Moisture Resistance (500 hours; 90-95% RH @40°C)	Δ Capacitance: + 30% ~ -20% Leakage Current: less than value in specifications table. Dissipation Factor: less than value in specifications table.	
Load Life Test (rated voltage @ 85°C) 1000 hours	Δ Capacitance: \pm 30% Leakage Current: less than value in specifications table. Dissipation Factor: 150% of value in specifications table.	
Base Failure Rate	1%/1000 hours at +85°C	

* It is recommended that the applied voltage be less than 80% of the rated voltage

CASE SIZES AND MAXIMUM DISSIPATION FACTOR

Rated Voltage @ +85 °C	2.5	4	6.3	10	16	
Surge Voltage @ +85 °C	3.3	5.2	8	13	20	
Derated Voltage @ 105°C	2.0	3.3	5	8	12.8	
Capacitance μ F	Code	Case Sizes	Case Sizes	Case Sizes	Case Sizes	Case Sizes
2.2	225	-	-	J (4%)	J (4%)	-
3.3	335	-	-	J (4%) P (6%)	A (6%)	A (6%)
4.7	475	-	-	J (4%) P (6%)	A2/A (6%)	B (8%)
6.8	685	-	-	P/A (6%)	A (6%) B (8%)	B (8%)
10	106	-	J (4%) P/A (6%)	P/A2/A (6%)	A (6%) B (8%)	-
15	156	-	-	A (6%) B (8%)	B (8%) C (9%)	-
22	226	-	B (8%)	A (6%) B2 (10%) B (8%)	B2/B (8%) C (9%)	-
33	336	-	A (6%)	B2 (10%) B (8%)	B (8%) C (9%)	-
47	476	-	A (6%) B2 (8%)	B2/B (8%) C (9%)	B (8%) C (9%) V/D (10%)	D (10%)
68	686	-	C (9%)	B (8%) C (9%)	V/D (10%)	-
100	107	B2 (8%)	B2/B (8%)	B (8%) C (9%)	V/D (10%)	-
150	157	-	B (8%) C (9%)	C (9%) V/D (10%)	D (10%)	-
220	227	B (8%)	C (9%) V/D (10%)	D (10%)	D (10%)	-
330	337	V (10%)	D (10%)	D (10%)	-	-
470	477	-	D (10%)	-	-	-
680	687	D (10%)	D (10%)	-	-	-

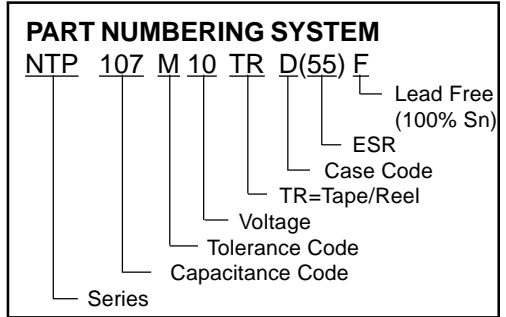

SURFACE MOUNT



Surface Mount Polymer-Tantalum Capacitor

NTP Series

MAX. ESR (mΩ) @ 20°C/100KHz

RIPPLE CURRENT (mA_{rms}) @ 20°C/100KHz

Capacitance (μF)	Working Voltage (Vdc)				
	2.5	4	6.3	10	16
2.2	-	-	J(600)=129	J(600)=129	-
3.3	-	-	J(600)=129 P(500)=224	A(800)=306	A(800)=306
4.7	-	-	J(600)=129 P(500)=224	A2(500)=346 A(800)=306	B(600)=376
6.8	-	-	P(500)=224 A(800)=306	A(800)=306 B(500)=412	B(600)=376
10	-	J(600)=129 P(500)=224 A(500)=387	P(500)=224 A2(500)=346 A(500)=387	A(300)=500 B(300)=532	-
15	-	-	A(500)=387 B(300)=532	B(300)=532 C(200)=742	-
22	-	B(300)=532	A(500)=387 B2(80)=968 B(300)=532	B2(80)=968 B(300)=532 C(150)=856	-
33	-	A(500)=387	B2(80)=968 B(300)=532	B(200)=652 C(100)=1049	-
47	-	A(200)=612 B2(80)=968	B2(80)=968 B(200)=652 B(70)=1102 C(100)=1049	B(70)=1102 C(100)=1049 V(60)=1443 D(100)=1225	D(70)=1464
68	-	C(100)=1049	B(200)=652 B(55)=1243 C(100)=1049	V(60)=1443 D(100)=1225	-
100	B2(80)=968	B2(80)=968 B(70)=1102 B(45)=1374	B(70)=1102 B(45)=1374 C(100)=1049	V(45)=1667 D(55)=1651	-
150	-	B(45)=1374 B(35)=1558 C(100)=1049	C(100)=1049 C(55)=1414 V(45)=1667 D(55)=1651 D(40)=1936 D(25)=2449	D(55)=1651 D(40)=1936	-
220	B(45)=1374	C(55)=1414 V(45)=1667 V(25)=2236 V(18)=2635 V(15)=2887 D(55)=1651 D(40)=1936 D(25)=2449 D(15)=3162	D(55)=1651 D(40)=1936	D(55)=1651 D(40)=1936 D(25)=2449	-
330	V(25)=2236 V(15)=2887	D(40)=1936 D(25)=2449 D(15)=3162	D(40)=1936 D(25)=2449	-	-
470	-	D(25)=2449 D(18)=2887 D(15)=3162 D(12)=3536	-	-	-
680	D(25)=2449	D(25)=2449	-	-	-

SURFACE MOUNT

“J, P, A2, A” Case Size

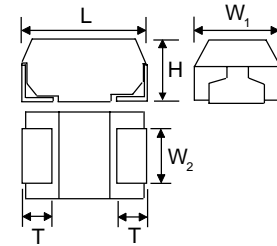

“B2, B” Case Size

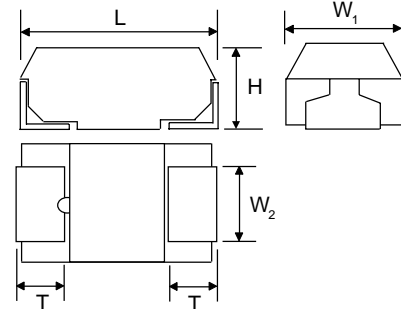

“C, V & D” Case Size

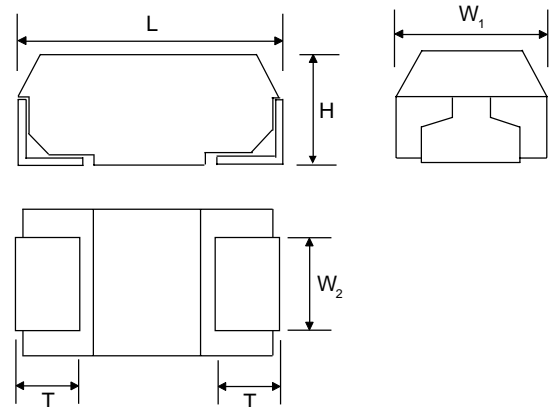

Polarity Indicator



Silver Band Denotes Anode Termination

SHADING DENOTES NEW VALUE

RIPPLE CURRENT TEMPERATURE DERATING

20°C	85°C	105°C
1.0	0.9	0.6

CASE DIMENSIONS (mm)

Case Size	EIA Code	L	H	W ₁	W ₂	T
J	0603	1.6 ± 0.1	0.8 ± 0.1	0.8 ± 0.1	0.8 ± 0.1	0.3 ± 0.15
P	2012	2.0 ± 0.2	1.1 ± 0.1	1.25 ± 0.2	0.9 ± 0.1	0.5 ± 0.1
A2	3216L	3.2 ± 0.2	1.1 ± 0.1	1.6 ± 0.2	1.2 ± 0.1	0.8 ± 0.3
A	3216	3.2 ± 0.2	1.6 ± 0.2	1.6 ± 0.2	1.2 ± 0.1	0.8 ± 0.3
B2	3528L	3.5 ± 0.2	1.1 ± 0.1	2.8 ± 0.2	2.2 ± 0.1	0.8 ± 0.3
B	3528	3.5 ± 0.2	1.9 ± 0.2	2.8 ± 0.2	2.3 ± 0.1	0.8 ± 0.3
C	6032	6.0 ± 0.2	2.5 ± 0.3	3.2 ± 0.2	1.8 ± 0.1	1.3 ± 0.3
V	7343	7.3 ± 0.2	1.9 ± 0.1	4.3 ± 0.2	2.4 ± 0.1	1.3 ± 0.3
D	7343	7.3 ± 0.2	2.8 ± 0.2	4.3 ± 0.2	2.4 ± 0.1	1.3 ± 0.3



TAPE SPECIFICATIONS (mm)

Case Size	A ± 0.2	B ± 0.2	C ± 0.3	D ± 0.1	E ± 0.1	F ± 0.1	G ± 0.05	H ± 0.1	J $+0.1$	K ± 0.2	t max.	Reel Qty
J	1.0	1.8	8.0	3.5	1.75	4.0	2.0	4.0	$\phi 1.5$	1.1	0.2	4000
P	1.4	2.2								1.4		3000
A2	1.9	3.5								1.4		3000
A	1.9									1.9		2000
B2	3.2	3.8								1.4		3000
B	3.3									2.1		2000
C	3.7	6.4	12.0	5.5	8.0	3.0	0.3	500				
V	4.8	7.7				2.1	0.4	1000				
D	4.8	7.7				3.3	0.3	500				

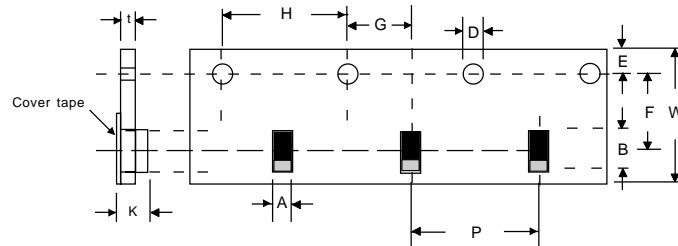

REEL SPECIFICATIONS (mm)

Tape Width	A ± 2.0	B min.	C ± 0.5	D ± 0.5	E ± 0.5	$W_1 \pm 1.0$	W_2 max.
8 mm	$\phi 178$	$\phi 50$	$\phi 13$	$\phi 21$	2.0	10	14.5
12 mm						14.5	18.5

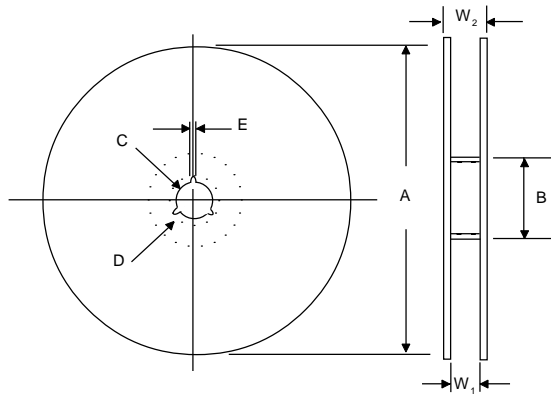

RECOMMENDED PEAK TEMPERATURE/TIME

Maximum Time	Peak Soldering Temperature
5 Seconds	250°C
10 Seconds	240°C
20 Seconds	230°C

RECOMMENDED LAND PATTERN (mm)

Case Size	S max.	X min.	Y min.
J	0.7	2.5	1.0
P	0.5	2.6	1.2
A	1.1	3.8	1.5
B	1.4	4.1	2.7
C	2.9	6.9	2.7
D	4.1	8.2	2.9

