

# T-1 PACKAGE SOLID STATE LAMP

## MVL-324B

### Description

The MVL-324B, a blue source color device, is made with InGaN ( on SiC substrate) LED die.  
The package is T-1(  $\phi$ mm) water clear plastic

### Package Dimensions

Unit : mm (inches)

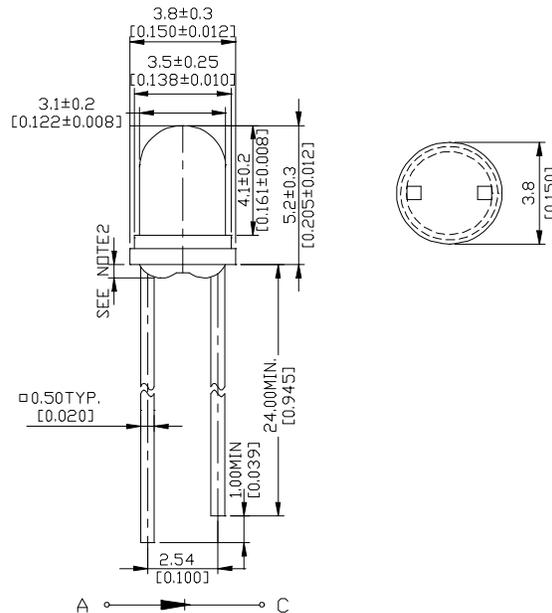

### Applications

- Full color displays & moving message signs
- Solid state incandescent replacement bulbs
- High ambient panel indicators
- Color printers & scanners
- Medical & Analytical instruments

### Features

- High performance - 2.5mW (470nm)
- Superior SiC substrate technology
- Excellent chip to chip consistency
- High reliability

#### Notes :

1. Tolerance is  $\pm 0.25$  mm (.010") unless otherwise noted.
2. Protruded resin under flange is 0.8 mm (.031") max.
3. Lead spacing is measured where the leads emerge from the package.

### Absolute Maximum Ratings

@  $T_A=25^\circ\text{C}$

| Parameter                                   | Symbol    | Maximum Rating   | Unit |
|---|-----------|------------------|------|
| Peak Forward Current(1/10 Duty Cycle@1KHz ) | $I_{pf}$  | 100              | mA   |
| Continuous Forward Current                  | $I_{af}$  | 30               | mA   |
| Reverse Voltage                             | $V_R$     | 5                | V    |
| Operating Temperature Range                 | $T_{opr}$ | -20°C to + 80°C  |      |
| Storage Temperature Range                   | $T_{stg}$ | -30°C to + 100°C |      |
| Electrostatic Discharge Threshold(HBM)      | $E_{ot}$  | 1000             | V    |

**UNI**

Unity Opto Technology Co., Ltd.

01/09/2002

## Optical-Electrical Characteristics

@ T<sub>A</sub>=25°C

| Parameter           | Test Conditions      | Symbol            | Min . | Typ . | Max . | Unit . |
|---------------------|----------------------|-------------------|-------|-------|-------|--------|
| Luminous Intensity  | I <sub>F</sub> =20mA | I <sub>V</sub>    | 100   | 200   | -     | mcd    |
| Forward Voltage     | I <sub>F</sub> =20mA | V <sub>F</sub>    | -     | 3.5   | 4.0   | V      |
| Reverse Current     | V <sub>R</sub> =5V   | I <sub>R</sub>    | -     | -     | 10    | μA     |
| Dominant Wavelength | I <sub>F</sub> =20mA | λ <sub>d</sub>    | -     | 470   | -     | nm     |
| Viewing Angle       | I <sub>F</sub> =20mA | 2θ <sub>1/2</sub> | -     | 40    | -     | deg.   |

## Typical Optical-Electrical Characteristic Curves

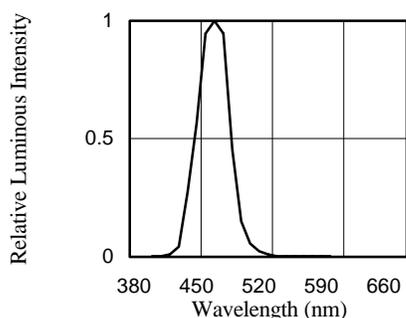

FIG.1 RELATIVE LUMINOUS INTENSITY VS. WAVELENGTH

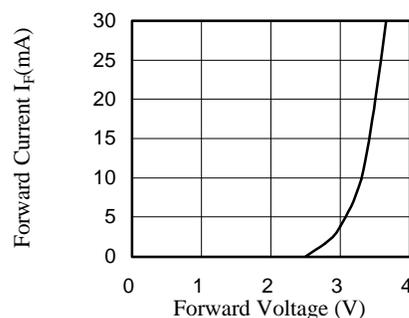

FIG.2 FORWARD CURRENT VS. FORWARD VOLTAGE

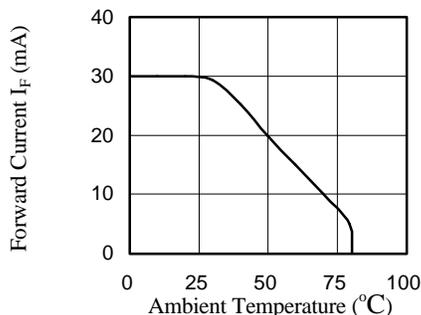

FIG.3 FORWARD CURRENT VS. AMBIENT TEMPERATURE

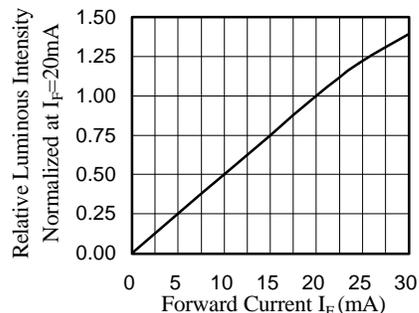

FIG.4 RELATIVE LUMINOUS INTENSITY VS. FORWARD CURRENT

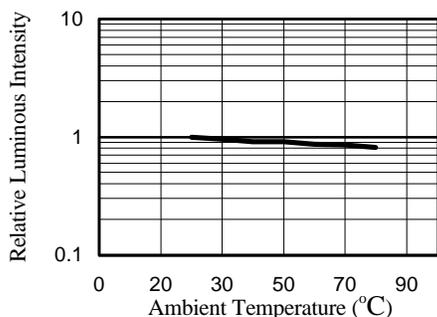

FIG.5 RELATIVE LUMINOUS INTENSITY VS. AMBIENT TEMPERATURE

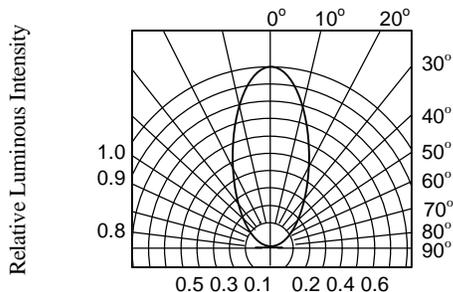

FIG.6 RADIATION DIAGRAM