

14×14 RA 1L3P TYPE

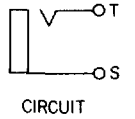

(Ni)	(Ni)
Ⓡ Ⓜ Ⓨ	Ⓨ Ⓨ Ⓨ
YKC21-3047	YKC21-3058
(Ni)	(Ni)
Ⓡ Ⓜ ↓ Ⓨ	Ⓨ Ⓨ ↓ Ⓨ
YKC21-3086	YKC21-3111
(Au)	(Au)
Ⓡ Ⓜ Ⓨ	Ⓨ Ⓨ Ⓨ
YKC21-3364	YKC21-3147
(Ni)	(Au)
Ⓨ Ⓜ Ⓡ	Ⓨ Ⓜ Ⓡ
YKC21-3039	YKC21-3059

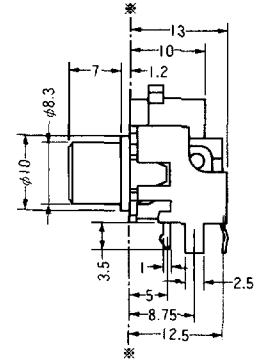
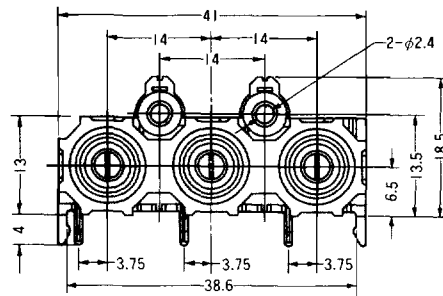
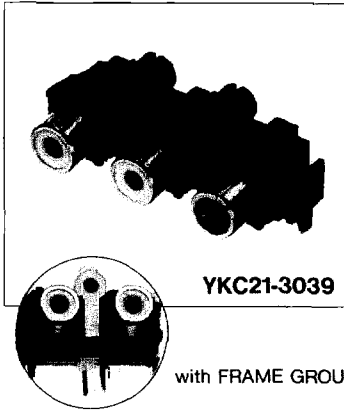
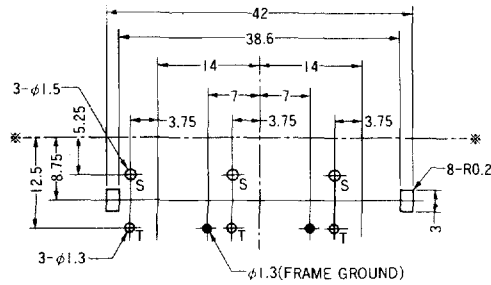

HOLE LAYOUT (PRINTED-SIDE VIEW)
PWB t=1.6

上表は代表例です。ご希望の仕様をご連絡下さい。
Above is just an example. Please ask for specification of your choice.

14×14 RA 2L6P TYPE

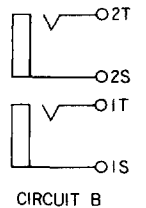
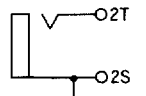
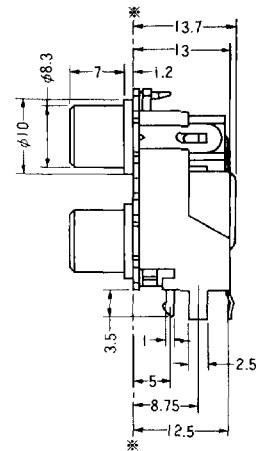
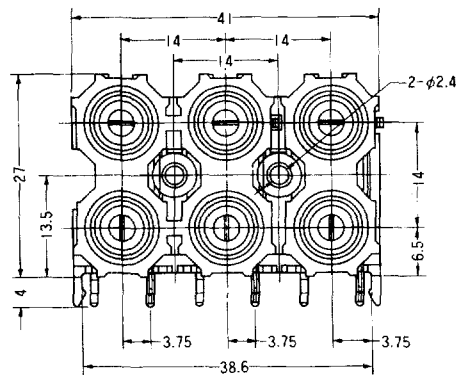
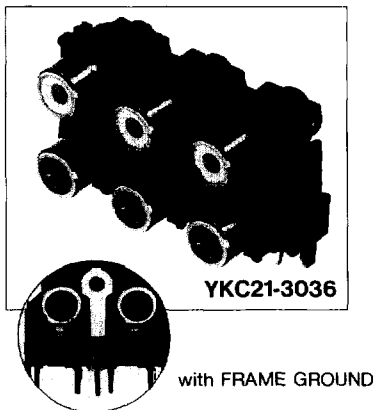

Ⓜ Ⓜ Ⓜ	(Ni)	Ⓡ Ⓡ Ⓡ	(Ni)
Ⓡ Ⓡ Ⓡ		Ⓜ Ⓜ Ⓜ	
YKC21-3036		YKC21-3174	
Ⓜ Ⓜ Ⓜ	(Ni)	Ⓡ Ⓡ Ⓡ	(Ni)
Ⓡ Ⓡ ↓ Ⓡ		Ⓜ Ⓜ ↓ Ⓜ	
YKC21-3164		YKC21-3283	
Ⓜ Ⓜ Ⓜ	(Au)	Ⓡ Ⓡ Ⓡ	(Au)
Ⓡ Ⓡ Ⓡ		Ⓜ Ⓜ Ⓜ	
YKC21-3144		YKC21-3158	
Ⓡ Ⓜ Ⓨ	(Ni)	Ⓡ Ⓡ Ⓡ	(Ni)
Ⓡ Ⓜ Ⓨ		Ⓡ Ⓡ Ⓡ	
YKC21-3123		YKC21-3154	

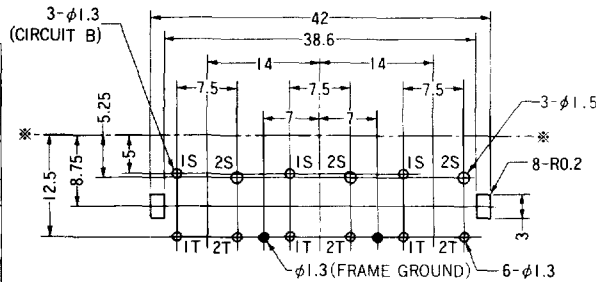

HOLE LAYOUT (PRINTED-SIDE VIEW)
PWB t=1.6

上表掲載品番の回路：CIRCUIT A
上表は代表例です。ご希望の仕様をご連絡下さい。
The model No. described in the above table：CIRCUIT A
Above is just an example. Please ask for specification of your choice.