

.050 Contact Centers (1.27mm)

.050 x .225 grid

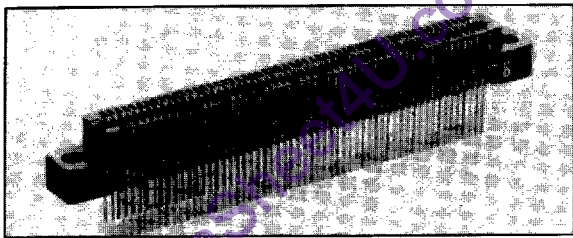

These .050" contact center connectors offer an opportunity for greater contact density in the card-edge format. Up to 64 dual positions are available, with dip solder terminations configured in either 2 rows or 4 staggered rows to facilitate loading into the p.c. board. Note that the smaller contact dimensions reduce the ability of the connector to withstand mistreatment and also require tighter tolerances on mating p.c. board traces.

OUTLINE AND DIMENSIONS

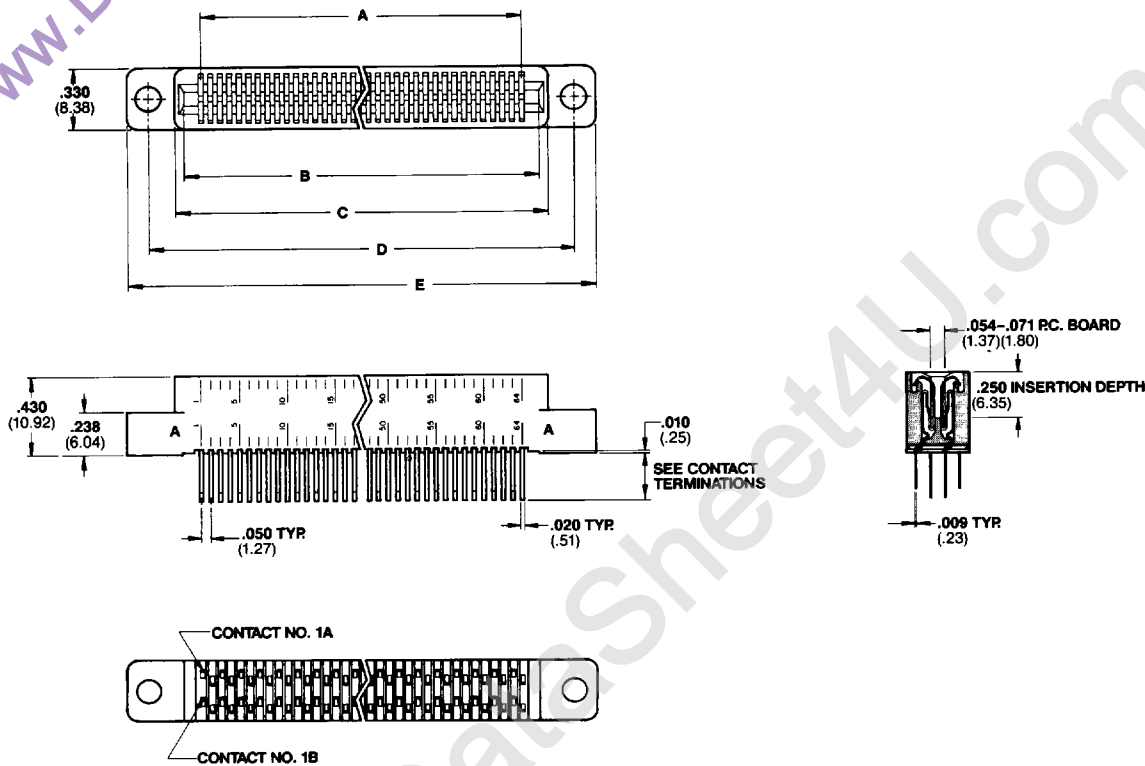

Contact Identification:

Numbers: 1, 5, 10, ... 64

Letters: A Near side, B Far side

CONTACT POSITIONS	A ±.007 (±.18)	B ±.007 (±.18)	C ±.010 (±.25)	D ±.007 (±.18)	E ±.015 (±.38)
6/12	.250 (6.35)	.426 (10.82)	.520 (13.21)	.800 (20.32)	1.020 (25.91)
10/20	.450 (11.43)	.626 (15.90)	.720 (18.29)	1.000 (25.40)	1.220 (30.99)
15/30	.700 (17.78)	.876 (22.25)	.970 (24.64)	1.250 (31.75)	1.470 (37.34)
25/50	1.200 (30.48)	1.376 (34.95)	1.470 (37.34)	1.750 (44.45)	1.970 (50.04)
30/60	1.450 (36.83)	1.626 (41.30)	1.720 (43.69)	2.000 (50.80)	2.220 (56.39)
40/80	1.950 (49.53)	2.126 (54.00)	2.220 (56.39)	2.500 (63.50)	2.720 (69.09)
64/128	3.150 (80.01)	3.326 (84.48)	3.420 (86.87)	3.700 (93.98)	3.920 (99.57)

Note: Dimensions are in inches and (millimeters). Tolerance ±.010(.25) unless otherwise specified.

5 ■ 9005376 0000005 996 ■

SPECIFICATIONS

ELECTRICAL

Operating Voltage:
250 Vdc (sea level)
Current Rating: 0.5 amp max.
Dielectric Withstanding Voltage:
375 Vrms min.
Insulation Resistance:
5000 megohms min.
Voltage Drop:
20 mV max.

TEMPERATURE RANGE

-65° C to +125° C
(-85° F to +257° F)

MECHANICAL

Contact Retention:
2.5 lbs. min.
Insertion Force:
1 to 8 oz. per opposing contact pair when using .062 (1.57) steel test blade.
Withdrawal Force:
.25 oz. min. per opposing contact pair when using .054(1.37) steel test blade.

MATERIALS

INSULATOR:
Diallyl Phthalate, per MIL-M-14, U.L. 94V-0 approved, color green
CONTACTS:
Copper alloy, gold plated per MIL-G-45204, Type II, Grade C, over nickel.
NOTE:
All tests are in accordance with requirements of MIL-C-21097.

CONTACT TERMINATIONS

NOTE:

Code V grid spacing is .050 (1.27) x .225 (5.71).

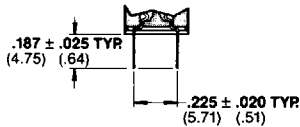

**DIP SOLDER
CODE V**

NOTE:

All dip solder terminations are .020 (.51) x .009 (.23) and fit .028 (.71) minimum diameter p.c. board hole.

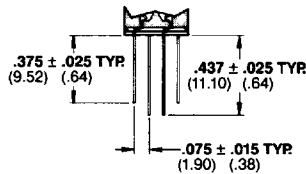

**DIP SOLDER
CODE Z**

RECOMMENDED P.C.B. HOLE PATTERN

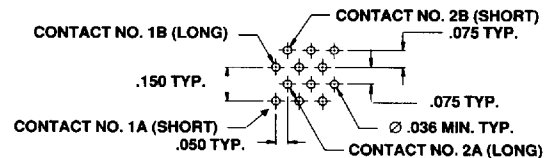

NOTE:

Code Z grid spacing is four staggered rows

MOUNTING STYLES

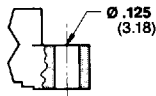

**THRU HOLE
CODE 5**



**NO EARS
CODE 12**

ORDERING INFORMATION

KH	25	/1	L	V	5
-----------	-----------	-----------	----------	----------	----------

CONTACT PLATING

KH: .000010 gold engagement and termination areas
VH: .000030 gold engagement and termination areas

NUMBER OF CONTACT PAIRS

6, 10, 15, 25, 30, 40, 64

INSULATOR MATERIAL

1: Diallyl Phthalate (green)

SERIES IDENTIFIER

L: .050 (1.27) Contact Centers; .062 (1.57) P.C. Board

CONTACT TERMINATIONS

V: Dip Solder
Z: Dip Solder Staggered Rows

MOUNTING STYLES

5: Thru Hole
12: No Ears

These series are nonstandard and require a factory quotation for price and delivery.

Hoods with Cable Clamp

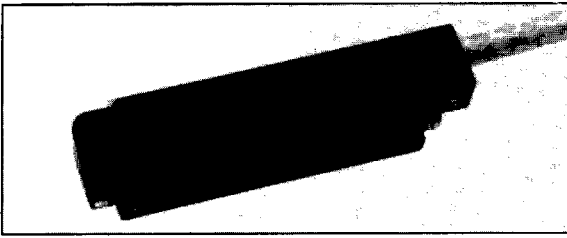

Hoods are available for most Viking card-edge connectors with style 5 mounts and suitable contact termination lengths. They are molded in thermoplastic and feature an integral cable clamp for a right-angle cable outlet. The cable clamp has a screw adjustment and accommodates cable sizes from 3/16" (4.76) diameter to 3/8" (9.52) diameter.

A hood assembly consists of two main parts, one of which "telescopes" into the other, thus fitting various lengths of connectors. Three different widths (Dim. "A") are available to suit the various connector series. The

hood is secured with two self-tapping screws which are provided. Consult the table to find the correct hood part number for your connector series and size.

OUTLINE AND DIMENSIONS

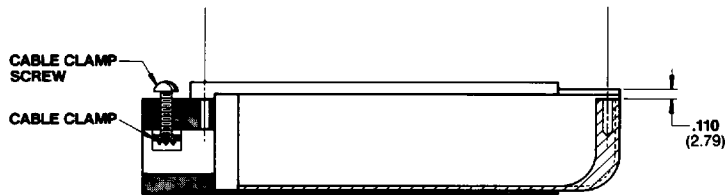
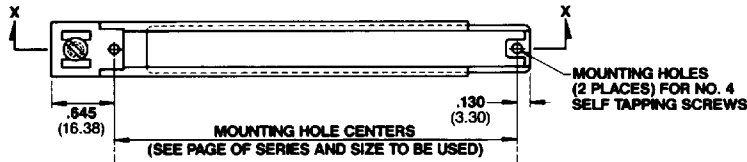
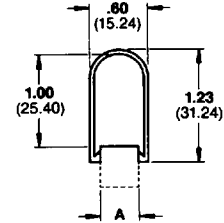
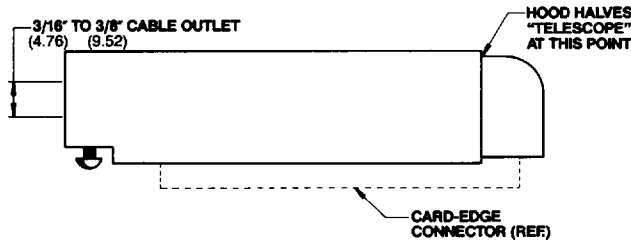

SECTION X-X

Connector Series	Dim. A	Contacts Per Row	Hood Assembly Part No.	Contacts Per Row	Hood Assembly Part No.	Contacts Per Row	Hood Assembly Part No.	Contacts Per Row	Hood Assembly Part No.
LV, LZ	.330	25-30	036-0097-004	40	036-0097-003	64	036-0097-002		
JDD, JE, JN, JV	.330	10	036-0097-004	15-25	036-0097-003	28-35	036-0097-002	36-50	036-0097-001
JND, JNK	.375	15-25	036-0098-003	28-36	036-0098-002	40-50	036-0098-001		
CDD, CE, CN, CV	.330	10-18	036-0097-003	22-28	036-0097-002	31-50	036-0097-001		
CND, CNK	.375	10-18	036-0098-003	22-30	036-0098-002	31-50	036-0098-001		
HNG	.400	18	036-0099-002	28-31	036-0099-001				
AB, ADD, AE, AK, AN, AV	.330	6	036-0097-004	10-15	036-0097-003	18-22	036-0097-002		
AMD, AMK, AND	.400	22	036-0099-002	28-43	036-0099-001				

Note: Dimensions are in inches and (millimeters). Tolerance ±.010(.25) unless otherwise specified.

Most Viking card-edge connectors have the option of "between-contacts" polarization or "in-contact" polarization.

Connectors with part number prefix "2" or "3" have grooves or slots between contacts into which the polarizing key is pressed. The appropriate "between-contacts" polarizing key is referenced on the data pages for each series. A Viking part number which

does not have a prefix of "2" or "3" does not have the "between-contacts" polarizing option.

If "in-contact" polarizing is desired, a pair of contacts must be removed and replaced by a key as detailed below. Therefore, two circuits are removed in the case of dual "readout" connectors and one circuit is removed in the case of single row connectors.

BETWEEN-CONTACTS



All .100", .125"
Contact Centers

Part Number: 091-0071-000
Material: Polyester
Key is pressed into grooves between contacts.

SLOT DIMENSIONS

A = .050(1.27)
B = .350(8.89)

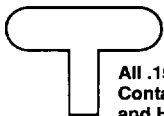

All .156"
Contact Centers
and HNG Series

Part Number: 091-0024-000
Material: GF Polyester
Key is pressed into slots between contacts.

SLOT DIMENSIONS

A = .050(1.27)
B = .350(8.89)

IN-CONTACT

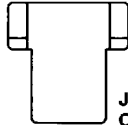

JDD, JE, JN, JV Series
CDD, CE, CN, CV Series

Part Number: 091-0025-000
Material: GF Nylon
Key replaces two opposing contacts.
Key is pressed into empty contact cavities.

SLOT DIMENSIONS

A = .070(1.77)
B = .350(8.89)

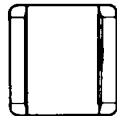

JND, JNK Series
CND, CNK Series
AMD, AMK, AND Series

Part Number: 091-0051-000
Material: GF Nylon
Key replaces two opposing contacts.
Key is pressed into empty contact cavities.

SLOT DIMENSIONS

A = .070(1.77)
B = .350(8.89)



JDD, JE, JN, JV Series
CDD, CE, CN, CV Series

Part Number: 091-0114-012
Material: Copper, Gold Plated
Key replaces two opposing contacts.
Tail is bent 90° after installation.

SLOT DIMENSIONS

A = .070(1.77)
B = .350(8.89)



ADD, AE, AKC,
AN, AV Series
HN, HV Series

Part Number: 091-0020-012
Material: Copper, Gold Plated
Key replaces two opposing contacts.
Tail is bent 90° after installation.

SLOT DIMENSIONS

A = .100(2.54)
B = .350(8.89)

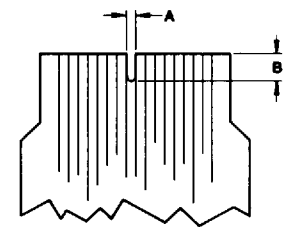

RECOMMENDED SLOT SIZE

Contact Replacement Tools

How To Replace Damaged Contacts

Wire Wrap, Round Tail Dip Solder and Pierced Eyelet Contacts Only

If a contact should become damaged and require replacement, special tools and replacement contacts are available. The technique and necessary tools are detailed below.

Wire Wrap and Round Tail Dip Solder Series AMD, AMK, AND, CND, CNK, HNG, JND, JNK

Viking's square wrap terminals and round tail dip solder terminals are retained in the insulator body by means of a press fit.

1. The use of an impact tool is suggested in removing the contact but other means can be used. Select the impact tool according to the chart. The impact tool slips over the tail of the damaged contact and is pushed firmly until the tool trips and drives the contact out.
2. Insert a replacement contact into the empty cavity from the front of the connector until the tail protrudes on the termination side.
3. Pull the tail using a pair of pliers until the contact is correctly seated and the tail is of equal length to the other contacts.

W/W Series	Replacement Contact	D/S Series	Replacement Contact	Impact Tool
AMD, AND	018-1140-002	AMK	018-1149-002	000407-0085
CND	018-1141-002	CNK	018-1151-002	000407-0085
HNG	018-0526-002			000407-0093
JND	018-1140-002	JNK	018-1149-002	000407-0085

Pierced Eyelet Series AN, CN, HN, JN

Viking's pierced eyelet terminals are retained in the insulator body by a dimple at the point where the tail enters the insulator.

1. Using the cut-off tool, cut off the tail at the "dimpled" area and remove the damaged contact.
2. Insert a replacement contact into the empty cavity from the front of the connector until it is completely seated.
3. While holding the contact in the seated position, place the dimple tool over the tail and squeeze to form a dimple on the flat metal at the base of the insulator. The dimple should preferably face out from the center of the connector. The dimple retains the contact in the insulator.

Pierced Series	Replacement Contact	Cut-Off Tool	Dimple Tool
AN	018-0906-002	115-0109-000	115-0108-000
CN	018-0905-002	115-0531-000	115-0532-000
HN	018-0028-002	115-0109-000	115-0108-000
JN	018-0905-002	115-0533-000	115-0534-000

