

SPECIFICATION FOR APPROVAL

- () Preliminary Specification
 (◆) Final Specification

| | |
|-------|-------------------|
| Title | 14.0"W HD TFT LCD |
|-------|-------------------|

| | |
|----------|----|
| Customer | HP |
| MODEL | |

| | |
|----------|----------------------|
| SUPPLIER | LG Display Co., Ltd. |
| *MODEL | LP140WH1 |
| Suffix | TLC1 |

*When you obtain standard approval,
 please use the above model name without suffix

| APPROVED BY | SIGNATURE |
|-------------|-----------|
| / | _____ |
| / | _____ |
| / | _____ |

Please return 1 copy for your confirmation with your signature and comments.

| APPROVED BY | SIGNATURE |
|------------------------|-----------|
| K. J. Kwon / S.Manager | _____ |
| REVIEWED BY | |
| M.J.Lee / Manager | _____ |
| PREPARED BY | |
| J.Y.Lee / Engineer | |
| C.H.Lee / Engineer | _____ |

Products Engineering Dept.
 LG Display Co., Ltd

Product Specification

Contents

| No | ITEM | Page |
|-----|---|-------|
| | COVER | 1 |
| | CONTENTS | 2 |
| | RECORD OF REVISIONS | 3 |
| 1 | GENERAL DESCRIPTION | 4 |
| 2 | ABSOLUTE MAXIMUM RATINGS | 5 |
| 3 | ELECTRICAL SPECIFICATIONS | |
| 3-1 | ELECTRICAL CHARACTERISTICS | 6 |
| 3-2 | INTERFACE CONNECTIONS | 7 |
| 3-3 | LVDS SIGNAL TIMING SPECIFICATION | 8-9 |
| 3-3 | SIGNAL TIMING SPECIFICATIONS | 9 |
| 3-4 | SIGNAL TIMING WAVEFORMS | 10 |
| 3-5 | COLOR INPUT DATA REFERENCE | 11 |
| 3-6 | POWER SEQUENCE | 12 |
| 4 | OPTICAL SPECIFICATIONS | 13-15 |
| 5 | MECHANICAL CHARACTERISTICS | 16-19 |
| 6 | RELIABILITY | 20 |
| 7 | INTERNATIONAL STANDARDS | |
| 7-1 | SAFETY | 21 |
| 7-2 | EMC | 21 |
| 8 | PACKING | |
| 8-1 | DESIGNATION OF LOT MARK | 22 |
| 8-2 | PACKING FORM | 22 |
| 9 | PRECAUTIONS | 23-24 |
| A | APPENDIX. Enhanced Extended Display Identification Data | 25-27 |

1. General Description

The LP140WH1 is a Color Active Matrix Liquid Crystal Display with an integral LED backlight system. The matrix employs a-Si Thin Film Transistor as the active element. It is a transmissive type display operating in the normally white mode. This TFT-LCD has 14.0 inches diagonally measured active display area with HD resolution(768 vertical by 1366 horizontal pixel array). Each pixel is divided into Red, Green and Blue sub-pixels or dots which are arranged in vertical stripes. Gray scale or the brightness of the sub-pixel color is determined with a 6-bit gray scale signal for each dot, thus, presenting a palette of more than 262,144 colors.

The LP140WH1 has been designed to apply the interface method that enables low power, high speed, low EMI.

The LP140WH1 is intended to support applications where thin thickness, low power are critical factors and graphic displays are important. In combination with the vertical arrangement of the sub-pixels, the LP140WH1 characteristics provide an excellent flat display for office automation products such as Notebook PC.

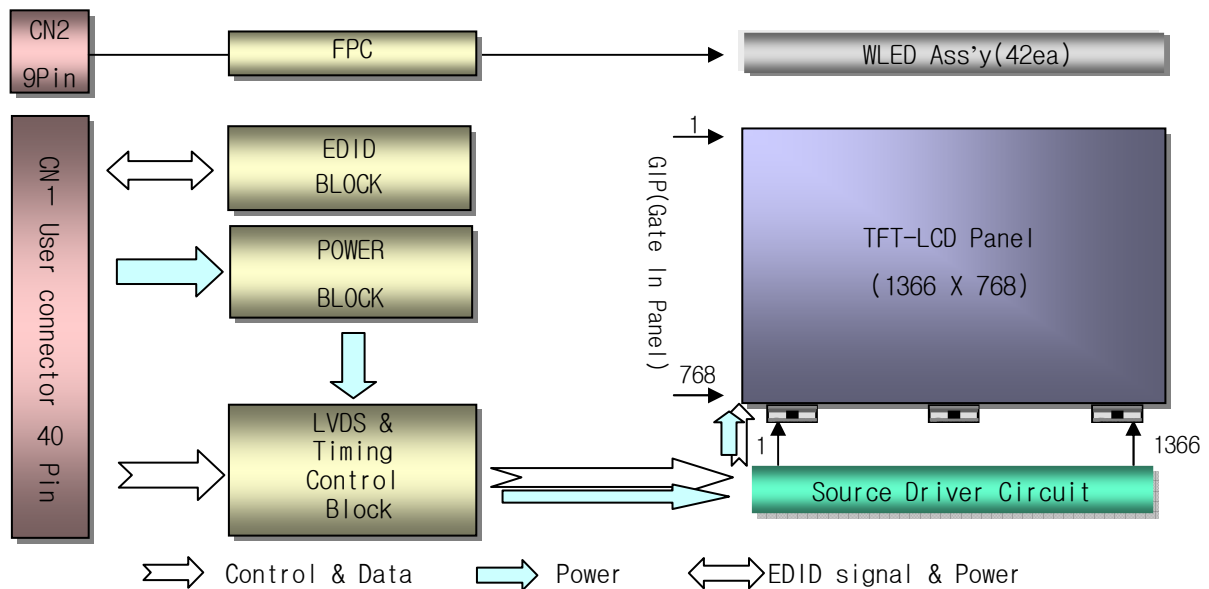

General Features

| | |
|------------------------|--|
| Active Screen Size | 14.0 inches diagonal |
| Outline Dimension | 323.5(H, typ) × 192.0(V, typ) × 5.2(D,max) [mm] |
| Pixel Pitch | 0.2265mm × 0.2265 mm |
| Pixel Format | 1366 horiz. By 768 vert. Pixels RGB strip arrangement |
| Color Depth | 6-bit, 262,144 colors |
| Luminance, White | 200 cd/m ² (Typ.5 point) |
| Power Consumption | Total 4.1 Watt(Typ.) @ LCM circuit 1.3 Watt(Typ.), B/L input 2.8Watt(Typ. with Driver) |
| Weight | 350g (Max.) |
| Display Operating Mode | Transmissive mode, normally white |
| Surface Treatment | Hard Coating(3H), Glare treatment of the front polarizer |
| RoHS Comply | Yes |

2. Absolute Maximum Ratings

The following are maximum values which, if exceeded, may cause faulty operation or damage to the unit.

Table 1. ABSOLUTE MAXIMUM RATINGS

| Parameter | Symbol | Values | | Units | Notes |
|----------------------------|--------|--------|-----|-------|-------------|
| | | Min | Max | | |
| Power Input Voltage | VCC | -0.3 | 4.0 | Vdc | at 25 ± 5°C |
| Operating Temperature | TOP | 0 | 50 | °C | 1 |
| Storage Temperature | HST | -20 | 60 | °C | 1 |
| Operating Ambient Humidity | HOP | 10 | 90 | %RH | 1 |
| Storage Humidity | HST | 10 | 90 | %RH | 1 |

Note : 1. Temperature and relative humidity range are shown in the figure below.
Wet bulb temperature should be 39°C Max, and no condensation of water.

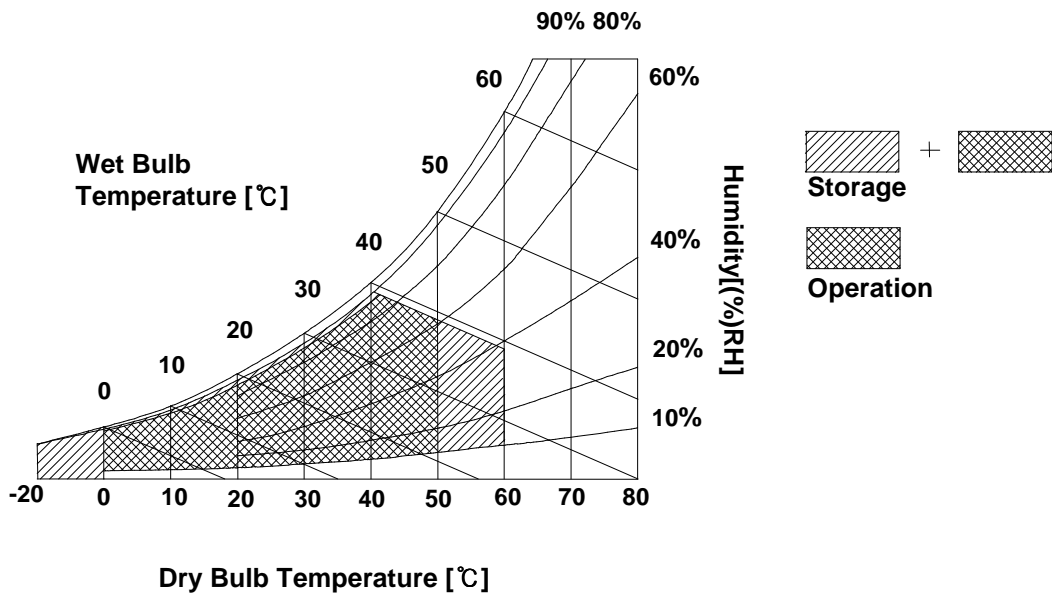

3. Electrical Specifications

3-1. Electrical Characteristics

The LP140WH1 requires two power inputs. The first logic is employed to power the LCD electronics and to drive the TFT array and liquid crystal. The second backlight is the input about LED BL.with LED Driver.

Table 2. ELECTRICAL CHARACTERISTICS

| Parameter | Symbol | Values | | | Unit | Notes | |
|---------------------------------------|-----------------------|-----------------|------|------|------|-------|---|
| | | Min | Typ | Max | | | |
| LOGIC : | | | | | | | |
| Power Supply Input Voltage | V _{CC} | 3.0 | 3.3 | 3.6 | V | | |
| Power Supply Input Current | Mosaic Pattern | I _{CC} | - | 400 | 465 | mA | 1 |
| | Black Pattern | I _{CC} | - | 500 | 575 | mA | |
| Power Consumption | P _{CC} | - | 1.3 | 1.5 | W | 1 | |
| Power Supply Inrush Current | I _{CC_P} | - | - | 1500 | mA | | |
| LVDS Impedance | Z _{LVDS} | 90 | 100 | 110 | Ω | 2 | |
| BACKLIGHT : (with LED Driver) | | | | | | | |
| LED Power Input Voltage | V _{LED} | 7.0 | 12.0 | 20.0 | V | | |
| LED Power Input Current | I _{LED} | - | 230 | 255 | mA | 3 | |
| LED Power Consumption | P _{LED} | - | 2.8 | 3.0 | W | 3 | |
| LED Power Inrush Current | I _{LED_P} | - | - | - | mA | | |
| PWM Dimming (Duty) Ratio | - | 12.5 | - | 100 | % | 4 | |
| PWM Impedance | Z _{PWM} | 20 | 40 | 60 | kΩ | | |
| PWM Frequency | F _{PWM} | 200 | - | 1000 | Hz | 5 | |
| PWM High Level Voltage | V _{PWM_H} | 2.1 | 3.3 | 5 | V | | |
| PWM Low Level Voltage | V _{PWM_L} | 0 | - | 0.8 | V | | |
| LED_EN High Voltage | V _{LED_EN_H} | 2.1 | 3.3 | 5 | V | | |
| LED_EN Low Voltage | V _{LED_EN_L} | 0 | - | 0.8 | V | | |
| Life Time | | 12,000 | - | - | Hrs | 6 | |

Note)

1. The specified I_{CC} current and power consumption are under the V_{CC} = 3.3V , 25°C , f_v = 60Hz condition whereas Mosaic pattern is displayed and f_v is the frame frequency.

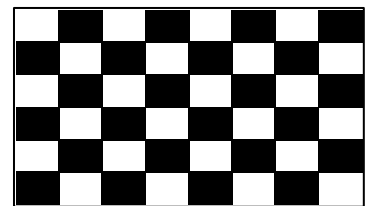

2. This impedance value is needed to proper display and measured from LVDS Tx to the mating connector.
3. The specified LED current and power consumption are under the V_{LED} = 12.0V , 25°C , Dimming of Max luminance whereas White pattern is displayed and f_v is the frame frequency.
4. The operation of LED Driver below minimum dimming ratio may cause flickering or reliability issue.
5. This specification is not effective at 100% dimming ratio as an exception because it has DC level equivalent to 0Hz. In spite of acceptable range as defined, the PWM Frequency should be fixed and stable for more consistent brightness control at any specific level desired.
6. The life time is determined as the sum of operating time at which brightness of LCM at the typical LED current is 50% compare to that of minimum value specified in table7. under general user condition.

3-2. Interface Connections

This LCD employs two interface connections, a 40 pin connector is used for the module electronics interface and the other connector is used for the integral backlight system.

The electronics interface connector is a model CABLINE-VS RECE ASS'Y manufactured by I-PEX.

Table 3. MODULE CONNECTOR PIN CONFIGURATION (CN1)

| Pin | Symbol | Description | Notes |
|-----|------------------------|--|--|
| 1 | NC | No Connection | <p>1, Interface chips 1.1 LCD : SW, SW0624 (LCD Controller) including LVDS Receiver 1.2 System : THC63LVDF823A or equivalent * Pin to Pin compatible with LVDS</p> <p>2. Connector 2.1 LCD : CABLINE-VS RECE ASS'Y, I-PEX or its compatibles 2.2 Mating : CABLINE-VS PLUG CABLE ASS'Y or equivalent. 2.3 Connector pin arrangement</p>  <p>[LCD Module Rear View]</p> |
| 2 | VCC | Power Supply, 3.3V Typ. | |
| 3 | VCC | Power Supply, 3.3V Typ. | |
| 4 | V EEDID | DDC 3.3V power | |
| 5 | NC | No Connection | |
| 6 | Clk EEDID | DDC Clock | |
| 7 | DATA EEDID | DDC Data | |
| 8 | Odd_R _{IN} 0- | Negative LVDS differential data input | |
| 9 | Odd_R _{IN} 0+ | Positive LVDS differential data input | |
| 10 | GND | Ground | |
| 11 | Odd_R _{IN} 1- | Negative LVDS differential data input | |
| 12 | Odd_R _{IN} 1+ | Positive LVDS differential data input | |
| 13 | GND | Ground | |
| 14 | Odd_R _{IN} 2- | Negative LVDS differential data input | |
| 15 | Odd_R _{IN} 2+ | Positive LVDS differential data input | |
| 16 | GND | Ground | |
| 17 | Odd_CLKIN- | Negative LVDS differential clock input | |
| 18 | Odd_CLKIN+ | Positive LVDS differential clock input | |
| 19 | GND | Ground | |
| 20 | NC | No Connection | |
| 21 | NC | No Connection | |
| 19 | GND | Ground | |
| 23 | NC | No Connection | |
| 24 | NC | No Connection | |
| 19 | GND | Ground | |
| 26 | NC | No Connection | |
| 27 | NC | No Connection | |
| 19 | GND | Ground | |
| 29 | NC | No Connection | |
| 30 | NC | No Connection | |
| 31 | VLED_GND | LED Ground | |
| 32 | VLED_GND | LED Ground | |
| 33 | VLED_GND | LED Ground | |
| 34 | NC | No Connection | |
| 35 | PWM | PWM for luminance control | |
| 36 | LED_EN | Backlight On/Off Control | |
| 37 | NC | No Connection (Reserved) | |
| 38 | VLED | LED Power Supply 7V-21V | |
| 39 | VLED | LED Power Supply 7V-21V | |
| 40 | VLED | LED Power Supply 7V-21V | |

Product Specification

3-3. LVDS Signal Timing Specifications

3-3-1. DC Specification

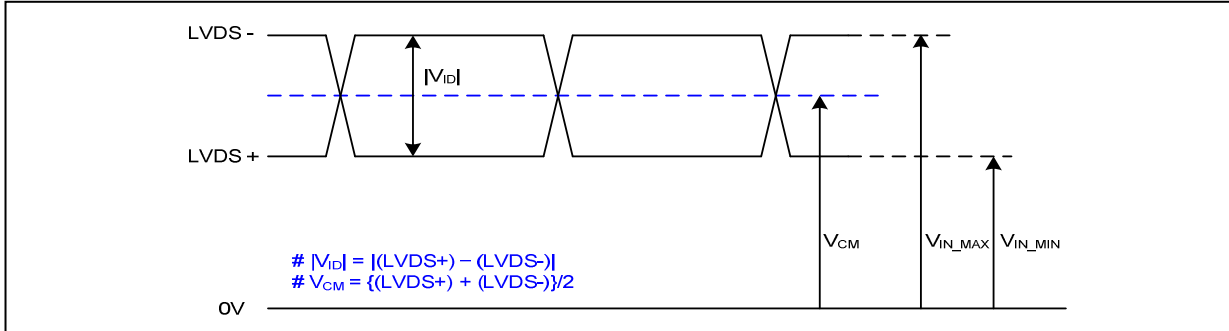

| Description | Symbol | Min | Max | Unit | Notes |
|---------------------------|------------|-----|-----|------|-------|
| LVDS Differential Voltage | $ V_{ID} $ | 100 | 600 | mV | - |
| LVDS Common mode Voltage | V_{CM} | 0.6 | 1.8 | V | - |
| LVDS Input Voltage Range | V_{IN} | 0.3 | 2.1 | V | - |

3-3-2. AC Specification

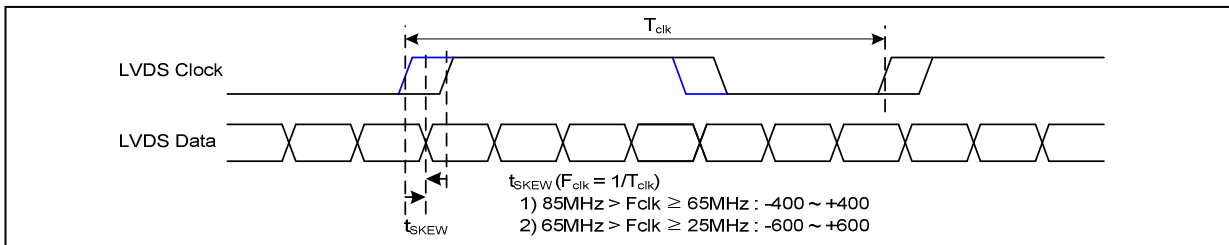

| Description | Symbol | Min | Max | Unit | Notes |
|--|----------------|-------|---------|-----------|------------------------------|
| LVDS Clock to Data Skew Margin | t_{SKEW} | - 400 | + 400 | ps | $85MHz > F_{clk} \geq 65MHz$ |
| | t_{SKEW} | - 600 | + 600 | ps | $65MHz > F_{clk} \geq 25MHz$ |
| LVDS Clock to Clock Skew Margin (Even to Odd) | t_{SKEW_EO} | - 1/7 | + 1/7 | T_{clk} | - |
| Maximum deviation of input clock frequency during SSC | F_{DEV} | - | ± 3 | % | - |
| Maximum modulation frequency of input clock during SSC | F_{MOD} | - | 200 | KHz | - |

Product Specification

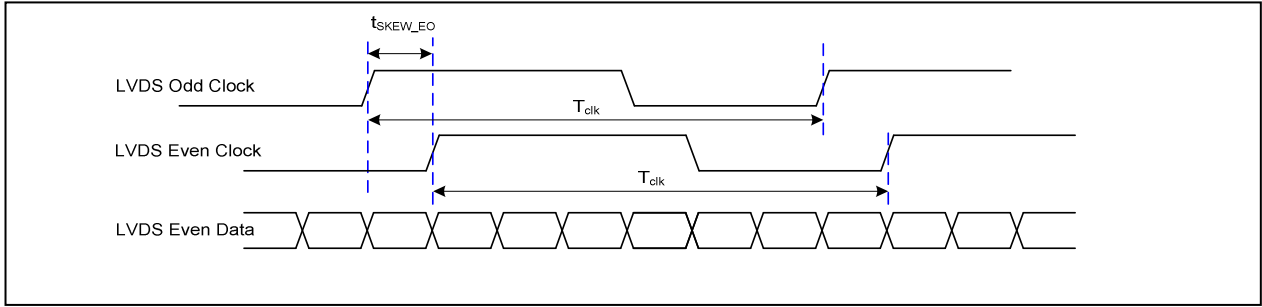

< Clock skew margin between channel >

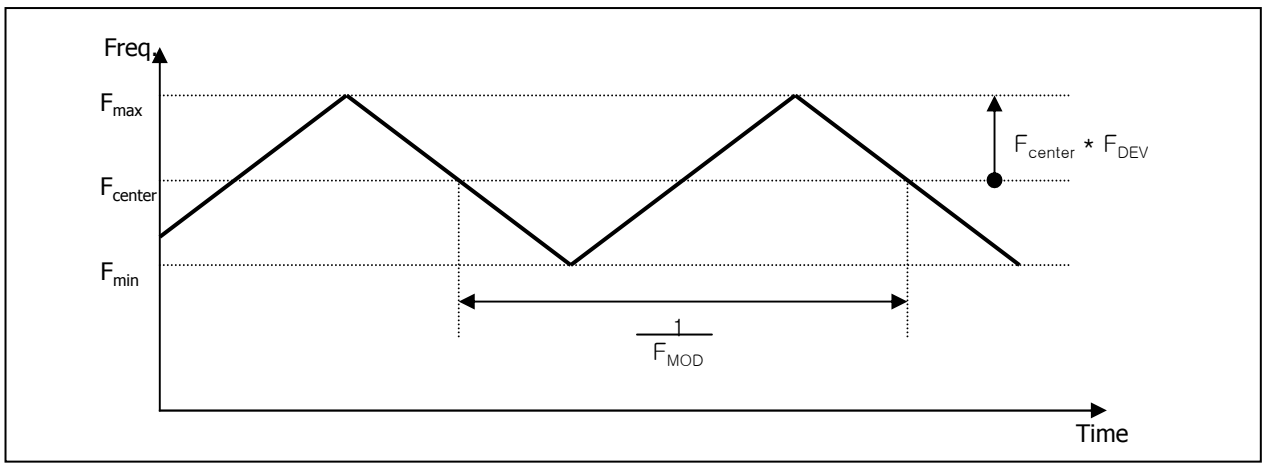

< Spread Spectrum >

3-3-3. Data Format

1) LVDS 1 Port

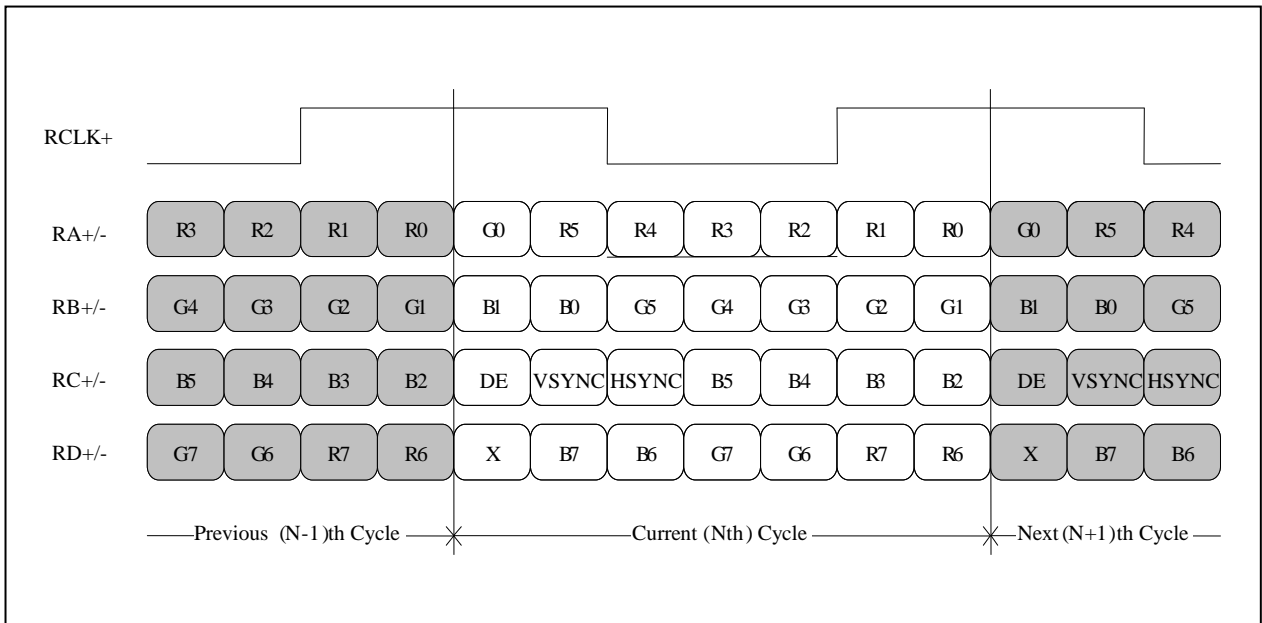

< LVDS Data Format >

3-4. Signal Timing Specifications

This is the signal timing required at the input of the User connector. All of the interface signal timing should be satisfied with the following specifications and specifications of LVDS Tx/Rx for its proper operation.

Table 4. TIMING TABLE

| ITEM | Symbol | Min | Typ | Max | Unit | Note |
|-------------|------------------------|-----------|------|------|------|------|
| DCLK | Frequency | f_{CLK} | 68.7 | 72.3 | 76.2 | MHz |
| Hsync | Period | t_{HP} | 1470 | 1526 | 1586 | tCLK |
| | Width | t_{WH} | 23 | 32 | 40 | |
| | Width-Active | t_{WHA} | 1366 | 1366 | 1366 | |
| Vsync | Period | t_{VP} | 779 | 790 | 801 | tHP |
| | Width | t_{WV} | 2 | 5 | 8 | |
| | Width-Active | t_{WVA} | 768 | 768 | 768 | |
| Data Enable | Horizontal back porch | t_{HBP} | 72 | 80 | 124 | tCLK |
| | Horizontal front porch | t_{HFP} | 8 | 48 | 48 | |
| | Vertical back porch | t_{VBP} | 8 | 14 | 20 | tHP |
| | Vertical front porch | t_{VFP} | 1 | 3 | 5 | |

3-5. Signal Timing Waveforms

Condition : VCC = 3.3V

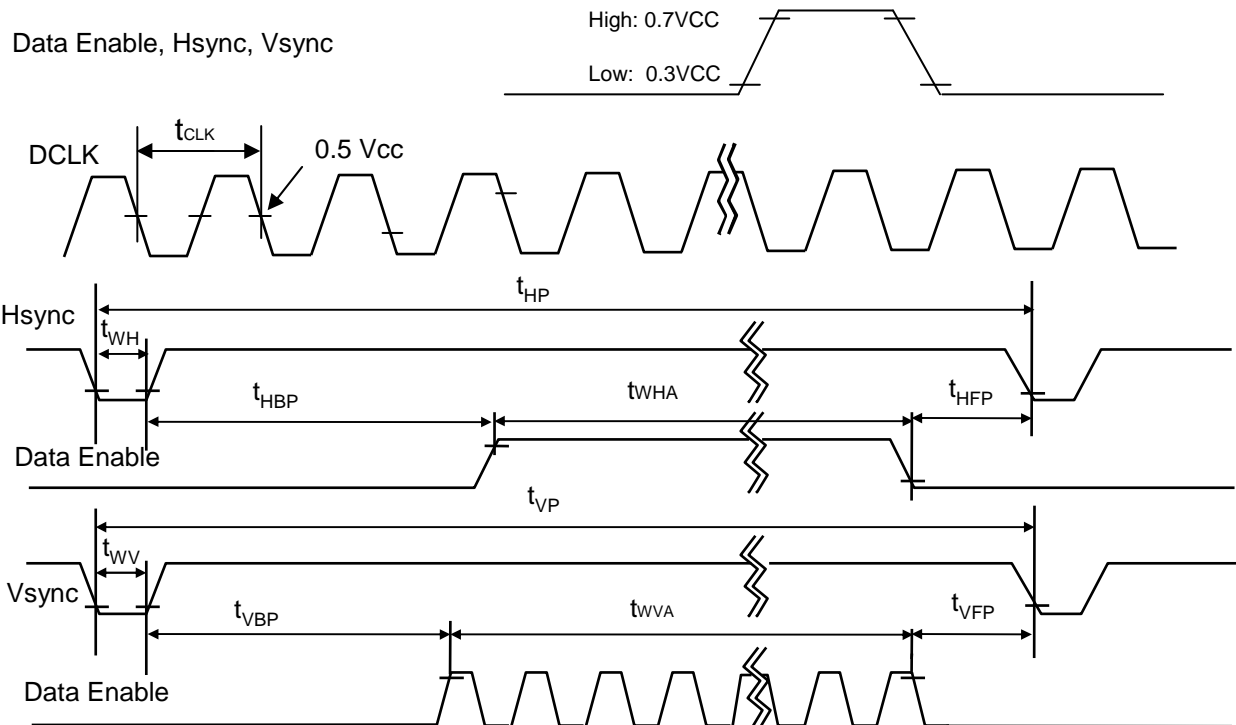

3-6. Color Input Data Reference

The brightness of each primary color (red, green and blue) is based on the 6-bit gray scale data input for the color ; the higher the binary input, the brighter the color. The table below provides a reference for color versus data input.

Table 5. COLOR DATA REFERENCE

| Color | | Input Color Data | | | | | | | | | | | | | | | | | |
|-------------|------------|------------------|-----|-----|-----|-----|-----|-------|-----|-----|-----|-----|-----|------|-----|-----|-----|-----|-----|
| | | RED | | | | | | GREEN | | | | | | BLUE | | | | | |
| | | MSB | | | | LSB | | MSB | | | | LSB | | MSB | | LSB | | | |
| | | R 5 | R 4 | R 3 | R 2 | R 1 | R 0 | G 5 | G 4 | G 3 | G 2 | G 1 | G 0 | B 5 | B 4 | B 3 | B 2 | B 1 | B 0 |
| Basic Color | Black | 0 | 0 | 0 | 0 | 0 | 0 | 0 | 0 | 0 | 0 | 0 | 0 | 0 | 0 | 0 | 0 | 0 | 0 |
| | Red | 1 | 1 | 1 | 1 | 1 | 1 | 0 | 0 | 0 | 0 | 0 | 0 | 0 | 0 | 0 | 0 | 0 | 0 |
| | Green | 0 | 0 | 0 | 0 | 0 | 0 | 1 | 1 | 1 | 1 | 1 | 1 | 0 | 0 | 0 | 0 | 0 | 0 |
| | Blue | 0 | 0 | 0 | 0 | 0 | 0 | 0 | 0 | 0 | 0 | 0 | 0 | 1 | 1 | 1 | 1 | 1 | 1 |
| | Cyan | 0 | 0 | 0 | 0 | 0 | 0 | 1 | 1 | 1 | 1 | 1 | 1 | 1 | 1 | 1 | 1 | 1 | 1 |
| | Magenta | 1 | 1 | 1 | 1 | 1 | 1 | 0 | 0 | 0 | 0 | 0 | 0 | 1 | 1 | 1 | 1 | 1 | 1 |
| | Yellow | 1 | 1 | 1 | 1 | 1 | 1 | 1 | 1 | 1 | 1 | 1 | 1 | 0 | 0 | 0 | 0 | 0 | 0 |
| | White | 1 | 1 | 1 | 1 | 1 | 1 | 1 | 1 | 1 | 1 | 1 | 1 | 1 | 1 | 1 | 1 | 1 | 1 |
| RED | RED (00) | 0 | 0 | 0 | 0 | 0 | 0 | 0 | 0 | 0 | 0 | 0 | 0 | 0 | 0 | 0 | 0 | 0 | 0 |
| | RED (01) | 0 | 0 | 0 | 0 | 0 | 1 | 0 | 0 | 0 | 0 | 0 | 0 | 0 | 0 | 0 | 0 | 0 | 0 |
| | ... | ... | | | | | | ... | | | | | | ... | | | | | |
| | RED (62) | 1 | 1 | 1 | 1 | 1 | 0 | 0 | 0 | 0 | 0 | 0 | 0 | 0 | 0 | 0 | 0 | 0 | 0 |
| | RED (63) | 1 | 1 | 1 | 1 | 1 | 1 | 0 | 0 | 0 | 0 | 0 | 0 | 0 | 0 | 0 | 0 | 0 | 0 |
| GREEN | GREEN (00) | 0 | 0 | 0 | 0 | 0 | 0 | 0 | 0 | 0 | 0 | 0 | 0 | 0 | 0 | 0 | 0 | 0 | 0 |
| | GREEN (01) | 0 | 0 | 0 | 0 | 0 | 0 | 0 | 0 | 0 | 0 | 0 | 1 | 0 | 0 | 0 | 0 | 0 | 0 |
| | ... | ... | | | | | | ... | | | | | | ... | | | | | |
| | GREEN (62) | 0 | 0 | 0 | 0 | 0 | 0 | 1 | 1 | 1 | 1 | 1 | 0 | 0 | 0 | 0 | 0 | 0 | 0 |
| | GREEN (63) | 0 | 0 | 0 | 0 | 0 | 0 | 1 | 1 | 1 | 1 | 1 | 1 | 0 | 0 | 0 | 0 | 0 | 0 |
| BLUE | BLUE (00) | 0 | 0 | 0 | 0 | 0 | 0 | 0 | 0 | 0 | 0 | 0 | 0 | 0 | 0 | 0 | 0 | 0 | 0 |
| | BLUE (01) | 0 | 0 | 0 | 0 | 0 | 0 | 0 | 0 | 0 | 0 | 0 | 0 | 0 | 0 | 0 | 0 | 0 | 1 |
| | ... | ... | | | | | | ... | | | | | | ... | | | | | |
| | BLUE (62) | 0 | 0 | 0 | 0 | 0 | 0 | 0 | 0 | 0 | 0 | 0 | 0 | 1 | 1 | 1 | 1 | 1 | 0 |
| | BLUE (63) | 0 | 0 | 0 | 0 | 0 | 0 | 0 | 0 | 0 | 0 | 0 | 0 | 1 | 1 | 1 | 1 | 1 | 1 |

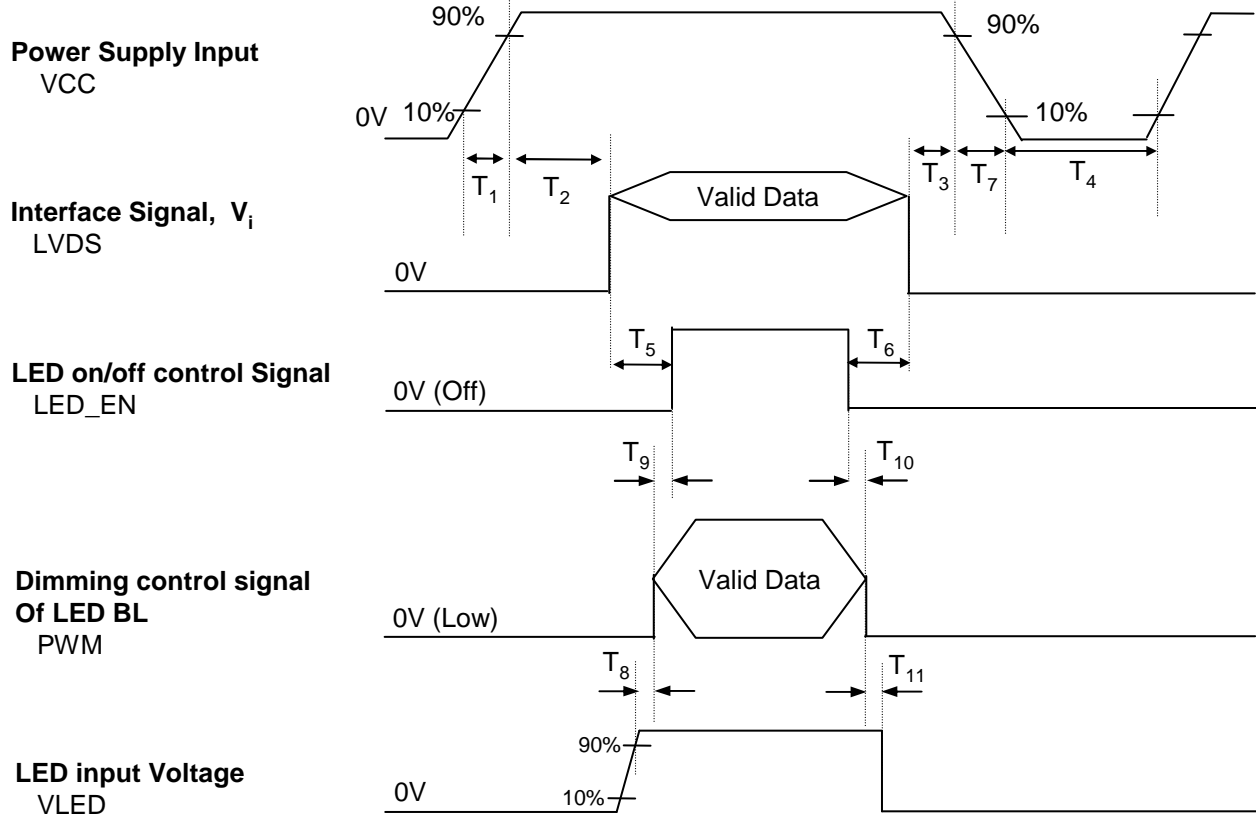
3-7. Power Sequence

Table 6. POWER SEQUENCE TABLE

| Parameter | Value | | | Units |
|-----------------|-------|------|------|-------|
| | Min. | Typ. | Max. | |
| T ₁ | 0.5 | - | 10 | ms |
| T ₂ | 0 | - | 50 | ms |
| T ₃ | 0 | - | 50 | ms |
| T ₄ | 400 | - | - | ms |
| T ₅ | 200 | - | - | ms |
| T ₆ | 200 | - | - | ms |
| T ₇ | 3 | - | 10 | ms |
| T ₈ | 10 | - | - | ms |
| T ₉ | 0 | - | - | ms |
| T ₁₀ | 0 | - | - | ms |
| T ₁₁ | 10 | - | - | ms |

Note)

- Valid Data is Data to meet "3-3. LVDS Signal Timing Specifications"
- Please avoid floating state of interface signal at invalid period.
- When the interface signal is invalid, be sure to pull down the power supply for LCD VCC to 0V.
- LED power must be turn on after power supply for LCD and interface signal are valid.

4. Optical Specification

Optical characteristics are determined after the unit has been 'ON' and stable for approximately 30 minutes in a dark environment at 25°C. The values specified are at an approximate distance 50cm from the LCD surface at a viewing angle of Φ and Θ equal to 0°.

FIG. 1 presents additional information concerning the measurement equipment and method.

FIG. 1 Optical Characteristic Measurement Equipment and Method

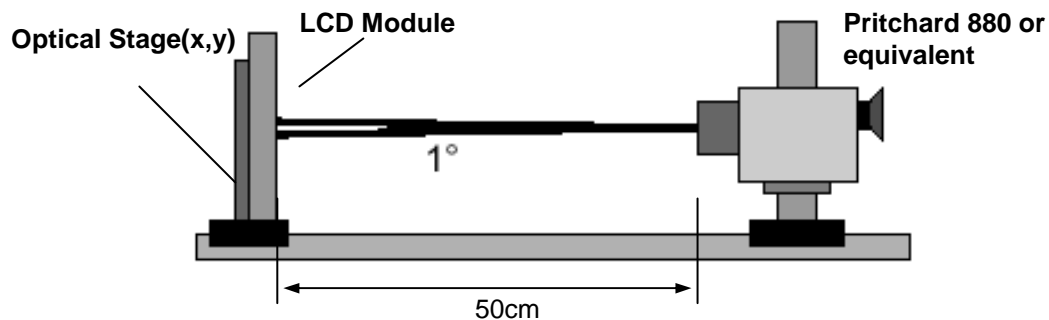

Table 7. OPTICAL CHARACTERISTICS

$T_a=25^\circ\text{C}$, $V_{CC}=3.3\text{V}$, $f_v=60\text{Hz}$, $f_{CLK}=72.3\text{MHz}$, $I_{LED}=18\text{mA}$

| Parameter | Symbol | Values | | | Units | Notes |
|-----------------------------------|--------------------|--------|-------|-------|-------------------|-------|
| | | Min | Typ | Max | | |
| Contrast Ratio | CR | 500 | - | - | | 1 |
| Surface Luminance, white | L_{WH} | 170 | 200 | - | cd/m ² | 2 |
| Luminance Variation | δ_{WHITE} | - | 1.4 | 1.6 | | 3 |
| Response Time | $T_{R+} + T_{R-D}$ | - | 16 | 24 | ms | 4 |
| Color Coordinates | | | | | | |
| RED | RX | 0.561 | 0.591 | 0.621 | | |
| | RY | 0.320 | 0.350 | 0.380 | | |
| GREEN | GX | 0.308 | 0.338 | 0.368 | | |
| | GY | 0.520 | 0.550 | 0.580 | | |
| BLUE | BX | 0.126 | 0.156 | 0.186 | | |
| | BY | 0.088 | 0.118 | 0.148 | | |
| WHITE | WX | 0.283 | 0.313 | 0.343 | | |
| | WY | 0.299 | 0.329 | 0.359 | | |
| Viewing Angle | | | | | | |
| x axis, right ($\Phi=0^\circ$) | Θ_r | 40 | - | - | degree | 5 |
| x axis, left ($\Phi=180^\circ$) | Θ_l | 40 | - | - | degree | |
| y axis, up ($\Phi=90^\circ$) | Θ_u | 10 | - | - | degree | |
| y axis, down ($\Phi=270^\circ$) | Θ_d | 30 | - | - | degree | |
| Gray Scale | | | | | | |
| | | | | | | 6 |

Product Specification

Note)

1. Contrast Ratio(CR) is defined mathematically as

$$\text{Contrast Ratio} = \frac{\text{Surface Luminance with all white pixels}}{\text{Surface Luminance with all black pixels}}$$

2. Surface luminance is the average of 5 point across the LCD surface 50cm from the surface with all pixels displaying white. For more information see FIG 1.

$$L_{WH} = \text{Average}(L_1, L_2, \dots, L_5)$$

 3. The variation in surface luminance, The panel total variation (δ_{WHITE}) is determined by measuring L_N at each test position 1 through 13 and then defined as followed numerical formula. For more information see FIG 2.

$$\delta_{WHITE} = \frac{\text{Maximum}(L_1, L_2, \dots, L_{13})}{\text{Minimum}(L_1, L_2, \dots, L_{13})}$$

 4. Response time is the time required for the display to transition from white to black (rise time, Tr_R) and from black to white(Decay Time, Tr_D). For additional information see FIG 3.

5. Viewing angle is the angle at which the contrast ratio is greater than 10. The angles are determined for the horizontal or x axis and the vertical or y axis with respect to the z axis which is normal to the LCD surface. For more information see FIG 4.

6. Gray scale specification

 * $f_V = 60\text{Hz}$

| Gray Level | Luminance [%] (Typ) |
|------------|---------------------|
| L0 | 0.16 |
| L7 | 0.97 |
| L15 | 4.30 |
| L23 | 10.59 |
| L31 | 19.92 |
| L39 | 34.80 |
| L47 | 55.61 |
| L55 | 79.40 |
| L63 | 100 |

FIG. 2 Luminance

<measuring point for surface luminance & measuring point for luminance variation>

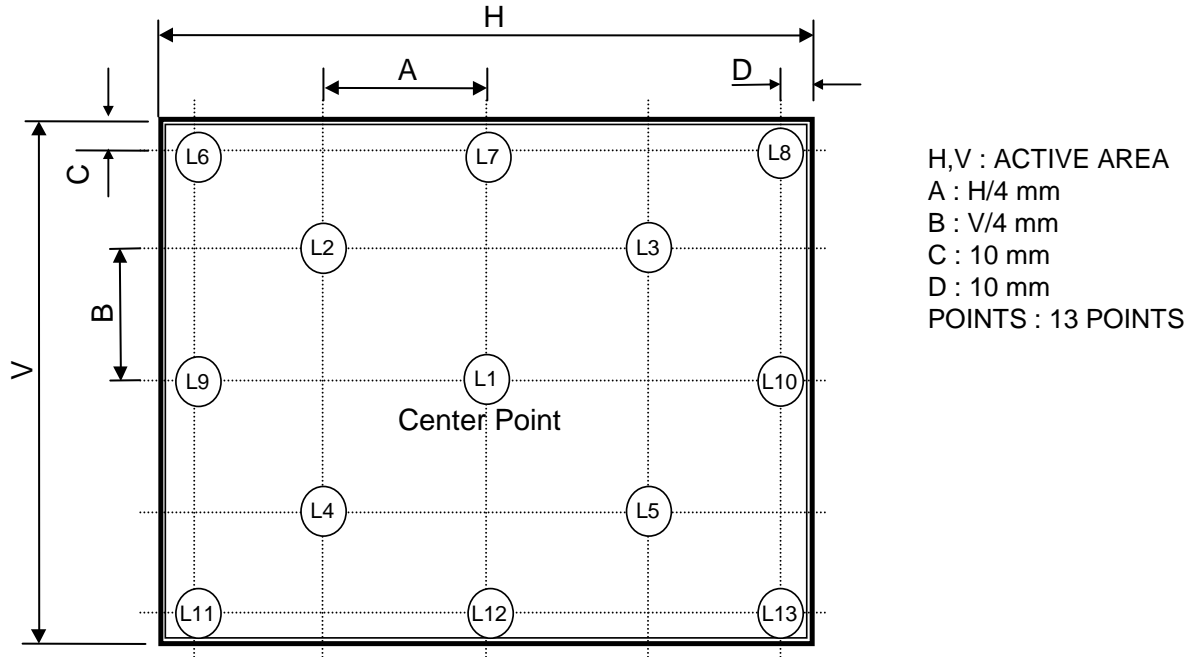
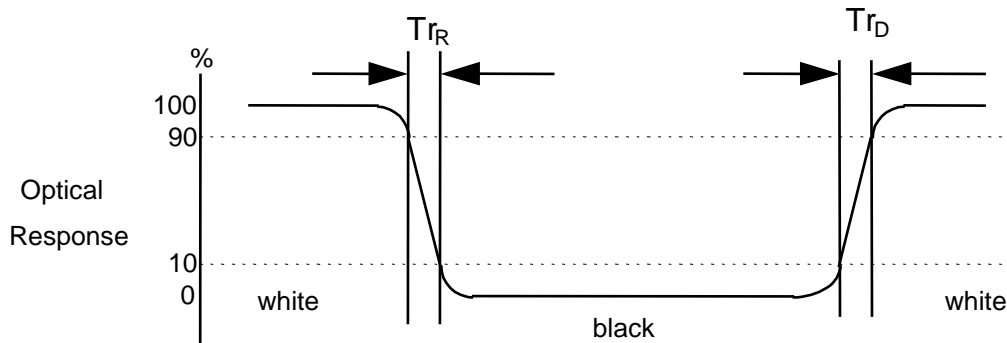

FIG. 3 Response Time

The response time is defined as the following figure and shall be measured by switching the input signal for “black” and “white”.



5. Mechanical Characteristics

The contents provide general mechanical characteristics for the model LP140WH1. In addition the figures in the next page are detailed mechanical drawing of the LCD.

| | | |
|---------------------|--|---------------|
| Outline Dimension | Horizontal | 323.5 ± 0.5mm |
| | Vertical | 192.0 ± 0.5mm |
| | Thickness | 5.2mm (max) |
| Bezel Area | Horizontal | 314.4 ± 0.5mm |
| | Vertical | 177.4 ± 0.5mm |
| Active Display Area | Horizontal | 309.40 mm |
| | Vertical | 173.95 mm |
| Weight | 350g (Max.) | |
| Surface Treatment | Hard Coating(3H), Glare treatment of the front polarizer | |

Product Specification

<FRONT VIEW>

Note) Unit:[mm], General tolerance: ± 0.5 mm

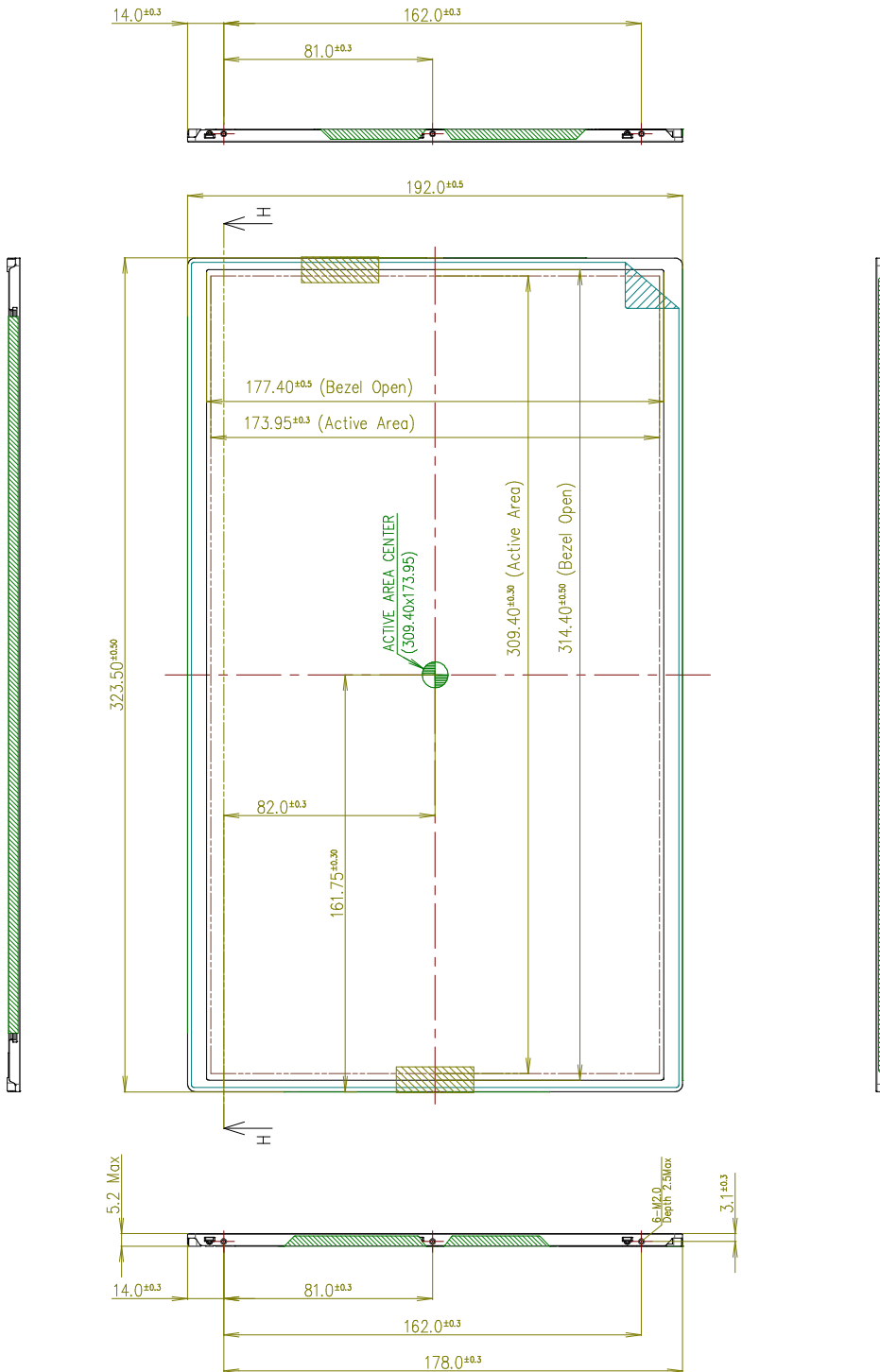

Product Specification

<REAR VIEW>

Note) Unit:[mm], General tolerance: ± 0.5mm

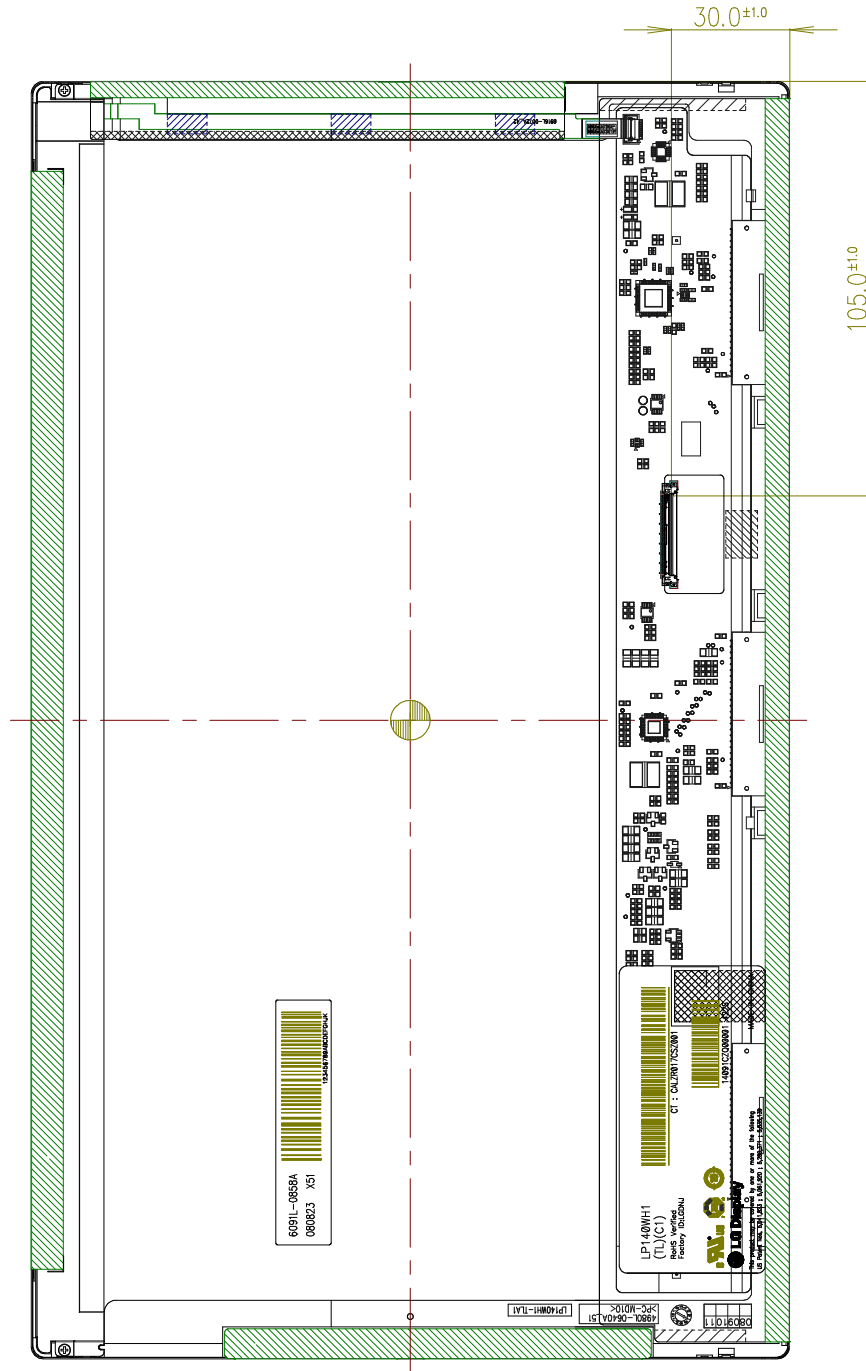

Product Specification

[DETAIL DESCRIPTION OF SIDE MOUNTING SCREW]

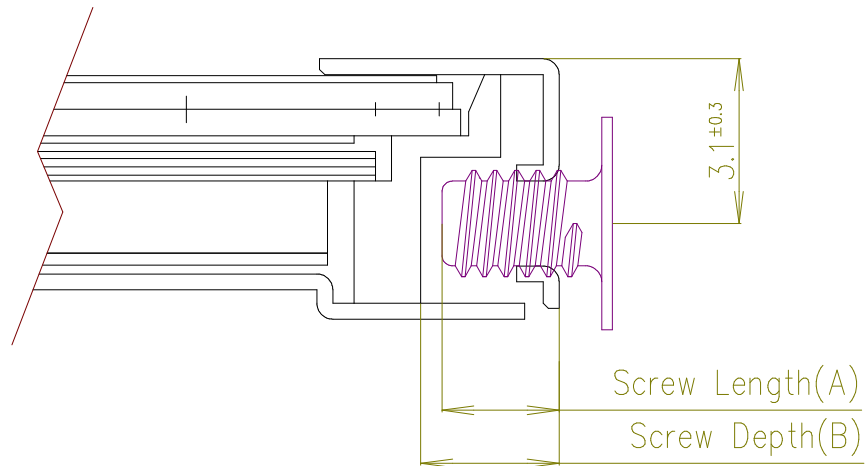

- * Mounting Screw Length (A)
= 2.0(Min) / 2.5(Max)
- * Mounting Screw Hole Depth (B)
= 2.5(Min)
- * Mounting hole location : 3.1(typ.)
- * Torque : 2.0 kgf.cm(Max)
(Measurement gauge : torque meter)

Notes : 1. Screw plated through the method of non-electrolytic nickel plating is preferred to reduce possibility that results in vertical and/or horizontal line defect due to the conductive particles from screw surface.

6. Reliability

Environment test condition

| No. | Test Item | Conditions |
|-----|---|--|
| 1 | High temperature storage test | Ta= 60°C, 240h |
| 2 | Low temperature storage test | Ta= -20°C, 240h |
| 3 | High temperature operation test | Ta= 50°C, 50%RH, 240h |
| 4 | Low temperature operation test | Ta= 0°C, 240h |
| 5 | Vibration test (non-operating) | Sine wave, 10 ~ 500 ~ 10Hz, 1.5G, 0.37oct/min 3 axis, 1hour/axis |
| 6 | Shock test (non-operating) | Half sine wave, 180G, 2ms one shock of each six faces(I.e. run 180G 2ms for all six faces) |
| 7 | Altitude operating storage / shipment | 0 ~ 10,000 feet (3,048m) 24Hr 0 ~ 40,000 feet (12,192m) 24Hr |

{ Result Evaluation Criteria }

There should be no change which might affect the practical display function when the display quality test is conducted under normal operating condition.

7. International Standards

7-1. Safety

- a) UL 60950-1:2003, First Edition, Underwriters Laboratories, Inc., Standard for Safety of Information Technology Equipment.
- b) CAN/CSA C22.2, No. 60950-1-03 1st Ed. April 1, 2003, Canadian Standards Association, Standard for Safety of Information Technology Equipment.
- c) EN 60950-1:2001, First Edition, European Committee for Electrotechnical Standardization(CENELEC) European Standard for Safety of Information Technology Equipment.

7-2. EMC

- a) ANSI C63.4 "Methods of Measurement of Radio-Noise Emissions from Low-Voltage Electrical and Electrical Equipment in the Range of 9kHz to 40GHz. "American National Standards Institute(ANSI), 1992
- b) C.I.S.P.R "Limits and Methods of Measurement of Radio Interface Characteristics of Information Technology Equipment." International Special Committee on Radio Interference.
- c) EN 55022 "Limits and Methods of Measurement of Radio Interface Characteristics of Information Technology Equipment." European Committee for Electrotechnical Standardization.(CENELEC), 1998 (Including A1: 2000)

8. Packing

8-1. Designation of Lot Mark

a) Lot Mark

| | | | | | | | | | | | | |
|---|---|---|---|---|---|---|---|---|---|---|---|---|
| A | B | C | D | E | F | G | H | I | J | K | L | M |
|---|---|---|---|---|---|---|---|---|---|---|---|---|

A,B,C : SIZE(INCH)
 E : MONTH

D : YEAR
 F ~ M : SERIAL NO.

Note

1. YEAR

| | | | | | | | | | | |
|------|------|------|------|------|------|------|------|------|------|------|
| Year | 2001 | 2002 | 2003 | 2004 | 2005 | 2006 | 2007 | 2008 | 2009 | 2010 |
| Mark | 1 | 2 | 3 | 4 | 5 | 6 | 7 | 8 | 9 | 0 |

2. MONTH

| | | | | | | | | | | | | |
|-------|-----|-----|-----|-----|-----|-----|-----|-----|-----|-----|-----|-----|
| Month | Jan | Feb | Mar | Apr | May | Jun | Jul | Aug | Sep | Oct | Nov | Dec |
| Mark | 1 | 2 | 3 | 4 | 5 | 6 | 7 | 8 | 9 | A | B | C |

b) Location of Lot Mark

Serial No. is printed on the label. The label is attached to the backside of the LCD module.
 This is subject to change without prior notice.

8-2. Packing Form

a) Package quantity in one box : 30 pcs

b) Box Size : 490 mm × 390 mm × 256 mm

9. PRECAUTIONS

Please pay attention to the followings when you use this TFT LCD module.

9-1. MOUNTING PRECAUTIONS

- (1) You must mount a module using holes arranged in four corners or four sides.
- (2) You should consider the mounting structure so that uneven force (ex. Twisted stress) is not applied to the module. And the case on which a module is mounted should have sufficient strength so that external force is not transmitted directly to the module.
- (3) Please attach the surface transparent protective plate to the surface in order to protect the polarizer. Transparent protective plate should have sufficient strength in order to resist external force.
- (4) You should adopt radiation structure to satisfy the temperature specification.
- (5) Acetic acid type and chlorine type materials for the cover case are not desirable because the former generates corrosive gas of attacking the polarizer at high temperature and the latter causes circuit break by electro-chemical reaction.
- (6) Do not touch, push or rub the exposed polarizers with glass, tweezers or anything harder than HB pencil lead. And please do not rub with dust clothes with chemical treatment. Do not touch the surface of polarizer for bare hand or greasy cloth. (Some cosmetics are detrimental to the polarizer.)
- (7) When the surface becomes dusty, please wipe gently with absorbent cotton or other soft materials like chamois soaks with petroleum benzene. Normal-hexane is recommended for cleaning the adhesives used to attach front / rear polarizers. Do not use acetone, toluene and alcohol because they cause chemical damage to the polarizer.
- (8) Wipe off saliva or water drops as soon as possible. Their long time contact with polarizer causes deformations and color fading.
- (9) Do not open the case because inside circuits do not have sufficient strength.

9-2. OPERATING PRECAUTIONS

- (1) The spike noise causes the mis-operation of circuits. It should be lower than following voltage :
 $V = \pm 200\text{mV}$ (Over and under shoot voltage)
- (2) Response time depends on the temperature. (In lower temperature, it becomes longer.)
- (3) Brightness depends on the temperature. (In lower temperature, it becomes lower.)
And in lower temperature, response time (required time that brightness is stable after turned on) becomes longer.
- (4) Be careful for condensation at sudden temperature change. Condensation makes damage to polarizer or electrical contacted parts. And after fading condensation, smear or spot will occur.
- (5) When fixed patterns are displayed for a long time, remnant image is likely to occur.
- (6) Module has high frequency circuits. Sufficient suppression to the electromagnetic interference shall be done by system manufacturers. Grounding and shielding methods may be important to minimize the interference.

9-3. ELECTROSTATIC DISCHARGE CONTROL

Since a module is composed of electronic circuits, it is not strong to electrostatic discharge. Make certain that treatment persons are connected to ground through wrist band etc. And don't touch interface pin directly.

9-4. PRECAUTIONS FOR STRONG LIGHT EXPOSURE

Strong light exposure causes degradation of polarizer and color filter.

9-5. STORAGE

When storing modules as spares for a long time, the following precautions are necessary.

- (1) Store them in a dark place. Do not expose the module to sunlight or fluorescent light. Keep the temperature between 5°C and 35°C at normal humidity.
- (2) The polarizer surface should not come in contact with any other object.
It is recommended that they be stored in the container in which they were shipped.

9-6. HANDLING PRECAUTIONS FOR PROTECTION FILM

- (1) When the protection film is peeled off, static electricity is generated between the film and polarizer.
This should be peeled off slowly and carefully by people who are electrically grounded and with well ion-blown equipment or in such a condition, etc.
- (2) The protection film is attached to the polarizer with a small amount of glue. If some stress is applied to rub the protection film against the polarizer during the time you peel off the film, the glue is apt to remain on the polarizer.
Please carefully peel off the protection film without rubbing it against the polarizer.
- (3) When the module with protection film attached is stored for a long time, sometimes there remains a very small amount of glue still on the polarizer after the protection film is peeled off.
- (4) You can remove the glue easily. When the glue remains on the polarizer surface or its vestige is recognized, please wipe them off with absorbent cotton waste or other soft material like chamois soaked with normal-hexane.

Product Specification

APPENDIX A. Enhanced Extended Display Identification Data (EEDID™) 1/3

| | Byte (Dec) | Byte (Hex) | Field Name and Comments | Value (Hex) | Value (Bin) | | |
|--------------------------|-------------------------|------------|--|---------------------------------|-------------|----------|----------|
| Header | 0 | 00 | Header | 00 | 00000000 | | |
| | 1 | 01 | Header | FF | 11111111 | | |
| | 2 | 02 | Header | FF | 11111111 | | |
| | 3 | 03 | Header | FF | 11111111 | | |
| | 4 | 04 | Header | FF | 11111111 | | |
| | 5 | 05 | Header | FF | 11111111 | | |
| | 6 | 06 | Header | FF | 11111111 | | |
| Vendor / Product Version | 7 | 07 | Header | 00 | 00000000 | | |
| | 8 | 08 | EISA manufacture code (3 Character ID) | LGD | 30 | 00110000 | |
| | 9 | 09 | EISA manufacture code (Compressed ASC II) | | E4 | 11100100 | |
| | 10 | 0A | Panel Supplier Reserved - Product Code | 01E1h | E1 | 11100001 | |
| | 11 | 0B | (Hex. LSB first) | | 01 | 00000001 | |
| | 12 | 0C | LCD Module Serial No - Preferred but Optional ("0" If not used) | | 00 | 00000000 | |
| | 13 | 0D | LCD Module Serial No - Preferred but Optional ("0" If not used) | | 00 | 00000000 | |
| | 14 | 0E | LCD Module Serial No - Preferred but Optional ("0" If not used) | | 00 | 00000000 | |
| | 15 | 0F | LCD Module Serial No - Preferred but Optional ("0" If not used) | | 00 | 00000000 | |
| | 16 | 10 | Week of Manufacture | 00 weeks | 00 | 00000000 | |
| Display Parameters | 17 | 11 | Year of Manufacture | 2008 years | 12 | 00010010 | |
| | 18 | 12 | EDID structure version # = 1 | | 01 | 00000001 | |
| | 19 | 13 | EDID revision # = 3 | | 03 | 00000011 | |
| | 20 | 14 | Video input Definition = Digital signal | | 80 | 10000000 | |
| | 21 | 15 | Max H image size (Rounded cm) = 31 cm | | 1F | 00011111 | |
| | 22 | 16 | Max V image size (Rounded cm) = 17 cm | | 11 | 00010001 | |
| | 23 | 17 | Display gamma = (gamma*100)-100 = Example:(2.2*100)-100=120 = 2.2 Gamma | | 78 | 01111000 | |
| | 24 | 18 | Feature Support (no_DPMS, no_Active_OH/Very Low Power, RGB color display, Timing BLK 1,no_GTF) | | 0A | 00001010 | |
| | Panel Color Coordinates | 25 | 19 | Red/Green Low Bits (RxRy/GxGy) | | 6B | 01101011 |
| | | 26 | 1A | Blue/White Low Bits (BxBY/WxWy) | | 15 | 00010101 |
| 27 | | 1B | Red X Rx = 0.591 | | 97 | 10010111 | |
| 28 | | 1C | Red Y Ry = 0.350 | | 59 | 01011001 | |
| 29 | | 1D | Green X Gx = 0.338 | | 56 | 01010110 | |
| 30 | | 1E | Green Y Gy = 0.550 | | 8C | 10001100 | |
| 31 | | 1F | Blue X Bx = 0.156 | | 28 | 00101000 | |
| 32 | | 20 | Blue Y By = 0.118 | | 1E | 00011110 | |
| 33 | | 21 | White X Wx = 0.313 | | 50 | 01010000 | |
| 34 | | 22 | White Y Wy = 0.329 | | 54 | 01010100 | |
| Established Timin | 35 | 23 | Established timing 1 (00h if not used) | | 00 | 00000000 | |
| | 36 | 24 | Established timing 2 (00h if not used) | | 00 | 00000000 | |
| | 37 | 25 | Manufacturer's timings (00h if not used) | | 00 | 00000000 | |
| Standard Timing ID | 38 | 26 | Standard timing ID1 (01h if not used) | | 01 | 00000001 | |
| | 39 | 27 | Standard timing ID1 (01h if not used) | | 01 | 00000001 | |
| | 40 | 28 | Standard timing ID2 (01h if not used) | | 01 | 00000001 | |
| | 41 | 29 | Standard timing ID2 (01h if not used) | | 01 | 00000001 | |
| | 42 | 2A | Standard timing ID3 (01h if not used) | | 01 | 00000001 | |
| | 43 | 2B | Standard timing ID3 (01h if not used) | | 01 | 00000001 | |
| | 44 | 2C | Standard timing ID4 (01h if not used) | | 01 | 00000001 | |
| | 45 | 2D | Standard timing ID4 (01h if not used) | | 01 | 00000001 | |
| | 46 | 2E | Standard timing ID5 (01h if not used) | | 01 | 00000001 | |
| | 47 | 2F | Standard timing ID5 (01h if not used) | | 01 | 00000001 | |
| | 48 | 30 | Standard timing ID6 (01h if not used) | | 01 | 00000001 | |
| | 49 | 31 | Standard timing ID6 (01h if not used) | | 01 | 00000001 | |
| | 50 | 32 | Standard timing ID7 (01h if not used) | | 01 | 00000001 | |
| | 51 | 33 | Standard timing ID7 (01h if not used) | | 01 | 00000001 | |
| | 52 | 34 | Standard timing ID8 (01h if not used) | | 01 | 00000001 | |
| | 53 | 35 | Standard timing ID8 (01h if not used) | | 01 | 00000001 | |

Product Specification

APPENDIX A. Enhanced Extended Display Identification Data (EEDID™) 2/3

| | Byte (Dec) | Byte (Hex) | Field Name and Comments | Value (Hex) | Value (Bin) | |
|----------------------|----------------------|------------|---|-------------|-------------|----------|
| Timing Descriptor #1 | 54 | 36 | Pixel Clock/10,000 (LSB) 72.3 MHz @ 60Hz | 3E | 00111110 | |
| | 55 | 37 | Pixel Clock/10,000 (MSB) | 1C | 00011100 | |
| | 56 | 38 | Horizontal Active (lower 8 bits) 1366 Pixels | 56 | 01010110 | |
| | 57 | 39 | Horizontal Blanking(Thp-HA) (lower 8 bits) 160 Pixels | A0 | 10100000 | |
| | 58 | 3A | Horizontal Active / Horizontal Blanking(Thp-HA) (upper 4:4bits) | 50 | 01010000 | |
| | 59 | 3B | Vertical Active 768 Lines | 00 | 00000000 | |
| | 60 | 3C | Vertical Blanking (Tvp-HA) (DE Blanking typ.for DE only panels) 22 Lines | 16 | 00010110 | |
| | 61 | 3D | Vertical Active : Vertical Blanking (Tvp-HA) (upper 4:4bits) | 30 | 00110000 | |
| | 62 | 3E | Horizontal Sync. Offset (Thfp) 48 Pixels | 30 | 00110000 | |
| | 63 | 3F | Horizontal Sync Pulse Width (HSPW) 32 Pixels | 20 | 00100000 | |
| | 64 | 40 | Vertical Sync Offset(Tvfp) : Sync Width (VSPW) 3 Lines : 5 Lines | 35 | 00110101 | |
| | 65 | 41 | Horizontal Vertical Sync Offset/Width (upper 2bits) | 00 | 00000000 | |
| | 66 | 42 | Horizontal Image Size (mm) 310 mm | 36 | 00110110 | |
| | 67 | 43 | Vertical Image Size (mm) 174 mm | AE | 10101110 | |
| | 68 | 44 | Horizontal Image Size / Vertical Image Size | 10 | 00010000 | |
| | 69 | 45 | Horizontal Border = 0 (Zero for Notebook LCD) | 00 | 00000000 | |
| | 70 | 46 | Vertical Border = 0 (Zero for Notebook LCD) | 00 | 00000000 | |
| | 71 | 47 | Non-Interlace, Normal display, no stereo, Digital Separate (Vsync_NEG, Hsync_NEG), DE only note : LSB is set to '1' if panel is DE-timing only. H/V can be ignored. | 19 | 00011001 | |
| | Timing Descriptor #2 | 72 | 48 | Flag | 00 | 00000000 |
| | | 73 | 49 | Flag | 00 | 00000000 |
| | | 74 | 4A | Flag | 00 | 00000000 |
| 75 | | 4B | Data Type Tag (Descriptor Defined by manufacturer) | 00 | 00000000 | |
| 76 | | 4C | Flag | 00 | 00000000 | |
| 77 | | 4D | Descriptor Defined by manufacturer | 00 | 00000000 | |
| 78 | | 4E | Descriptor Defined by manufacturer | 00 | 00000000 | |
| 79 | | 4F | Descriptor Defined by manufacturer | 00 | 00000000 | |
| 80 | | 50 | Descriptor Defined by manufacturer | 00 | 00000000 | |
| 81 | | 51 | Descriptor Defined by manufacturer | 00 | 00000000 | |
| 82 | | 52 | Descriptor Defined by manufacturer | 00 | 00000000 | |
| 83 | | 53 | Descriptor Defined by manufacturer | 00 | 00000000 | |
| 84 | | 54 | Descriptor Defined by manufacturer | 00 | 00000000 | |
| 85 | | 55 | Descriptor Defined by manufacturer | 00 | 00000000 | |
| 86 | | 56 | Descriptor Defined by manufacturer | 00 | 00000000 | |
| 87 | | 57 | Descriptor Defined by manufacturer | 00 | 00000000 | |
| 88 | | 58 | Descriptor Defined by manufacturer | 00 | 00000000 | |
| 89 | | 59 | Descriptor Defined by manufacturer | 00 | 00000000 | |
| Timing Descriptor #3 | | 90 | 5A | Flag | 00 | 00000000 |
| | 91 | 5B | Flag | 00 | 00000000 | |
| | 92 | 5C | Flag | 00 | 00000000 | |
| | 93 | 5D | Data Type Tag (ASCII String) | FE | 11111110 | |
| | 94 | 5E | Flag | 00 | 00000000 | |
| | 95 | 5F | ASCII String L | 4C | 01001100 | |
| | 96 | 60 | ASCII String G | 47 | 01000111 | |
| | 97 | 61 | ASCII String | 20 | 00100000 | |
| | 98 | 62 | ASCII String D | 44 | 01000100 | |
| | 99 | 63 | ASCII String i | 69 | 01101001 | |
| | 100 | 64 | ASCII String s | 73 | 01110011 | |
| | 101 | 65 | ASCII String p | 70 | 01110000 | |
| | 102 | 66 | ASCII String l | 6C | 01101100 | |
| | 103 | 67 | ASCII String a | 61 | 01100001 | |
| | 104 | 68 | ASCII String y | 79 | 01111001 | |
| | 105 | 69 | Manufacturer P/N(If<13 char--> 0Ah, then terminate with ASC II code 0Ah,set remaining char = 20h) | 0A | 00001010 | |
| | 106 | 6A | Manufacturer P/N(If<13 char--> 0Ah, then terminate with ASC II code 0Ah,set remaining char = 20h) | 20 | 00100000 | |
| | 107 | 6B | Manufacturer P/N(If<13 char--> 0Ah, then terminate with ASC II code 0Ah,set remaining char = 20h) | 20 | 00100000 | |

APPENDIX A. Enhanced Extended Display Identification Data (EEDID™) 3/3

| | Byte (Dec) | Byte (Hex) | Field Name and Comments | Value (Hex) | Value (Bin) |
|-----------------------------|---------------|----------------|--|----------------|----------------|
| Timing Descriptor #4 | 108 | 6C | Flag | 00 | 00000000 |
| | 109 | 6D | Flag | 00 | 00000000 |
| | 110 | 6E | Flag | 00 | 00000000 |
| | 111 | 6F | Data Type Tag (ASCII String) | FE | 11111110 |
| | 112 | 70 | Flag | 00 | 00000000 |
| | 113 | 71 | ASCII String L | 4C | 01001100 |
| | 114 | 72 | ASCII String P | 50 | 01010000 |
| | 115 | 73 | ASCII String 1 | 31 | 00110001 |
| | 116 | 74 | ASCII String 4 | 34 | 00110100 |
| | 117 | 75 | ASCII String 0 | 30 | 00110000 |
| | 118 | 76 | ASCII String W | 57 | 01010111 |
| | 119 | 77 | ASCII String H | 48 | 01001000 |
| | 120 | 78 | ASCII String 1 | 31 | 00110001 |
| | 121 | 79 | ASCII String - | 2D | 00101101 |
| | 122 | 7A | ASCII String T | 54 | 01010100 |
| 123 | 7B | ASCII String L | 4C | 01001100 | |
| 124 | 7C | ASCII String C | 43 | 01000011 | |
| 125 | 7D | ASCII String 1 | 31 | 00110001 | |
| Chec | 126 | 7E | Extension flag (# of optional 128 panel ID extension block to follow, Typ = 0) | 00 | 00000000 |
| | 127 | 7F | Check Sum (The 1-byte sum of all 128 bytes in this panel ID block shall = 0) | F3 | 11110011 |