

PLEASE CHECK WWW.MOLEX.COM FOR LATEST PART INFORMATION

Part Number: [0554821139](#)
Status: **Active**
Overview: [mini_mi_ii](#)
Description: 1.25mm (.049") Pitch Mini Mi II™ Wire-to-Wire Adapter, without Panel Mount Clip, 11 Circuits, Lead-free

Documents:

[3D Model](#) [Product Specification PS-55482-006 \(PDF\)](#)
[Drawing \(PDF\)](#) [RoHS Certificate of Compliance \(PDF\)](#)

General

Product Family	Accessories
Series	55482
Component Type	Adapter
Overview	mini_mi_ii
Product Name	Mini Mi II™

Physical

Circuits (Loaded)	11
Color - Resin	Natural
Gender	Male
Material - Metal	Brass
Material - Plating Mating	Tin
Material - Plating Termination	Tin
Material - Resin	Nylon
Number of Rows	1
Packaging Type	Bag
Plating min: Mating (µin)	40
Plating min: Mating (µm)	1.00
Plating min: Termination (µin)	40
Plating min: Termination (µm)	1.00
Temperature Range - Operating	-20°C to +80°C

Electrical

Current - Maximum per Contact	1.5A
-------------------------------	------

Material Info

Reference - Drawing Numbers

Product Specification	PS-55482-006
Sales Drawing	SD-55482-005

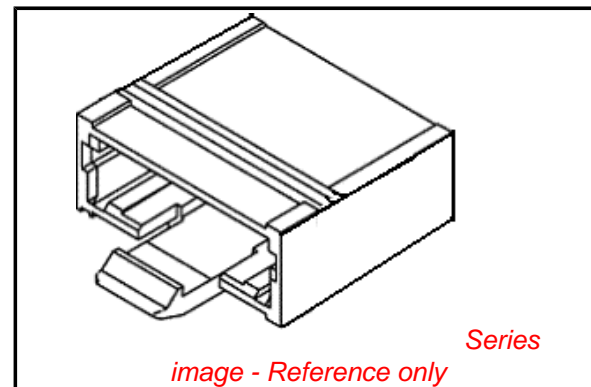

EU RoHS

**ELV and RoHS
Compliant**
**REACH SVHC
Not Reviewed**
**Halogen-Free
Status**

China RoHS



**Need more information on product
environmental compliance?**

Email productcompliance@molex.com
 For a multiple part number RoHS Certificate of Compliance, [click here](#)

Please visit the [Contact Us](#) section for any non-product compliance questions.

Search Parts in this Series

[55482Series](#)

Use With

[54596 IDT Housing](#)

10 9 8 7 6 5 4 3 2 1

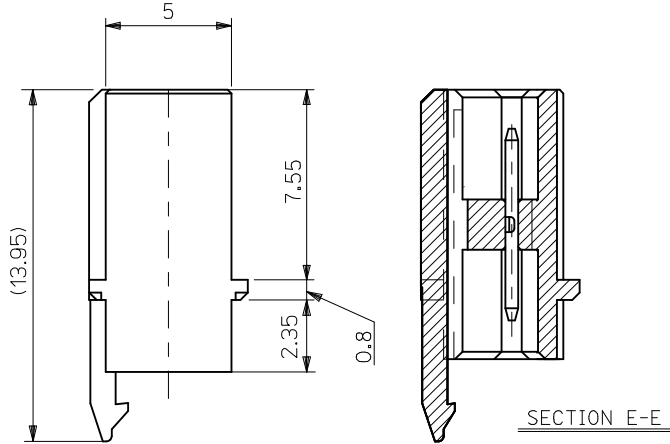
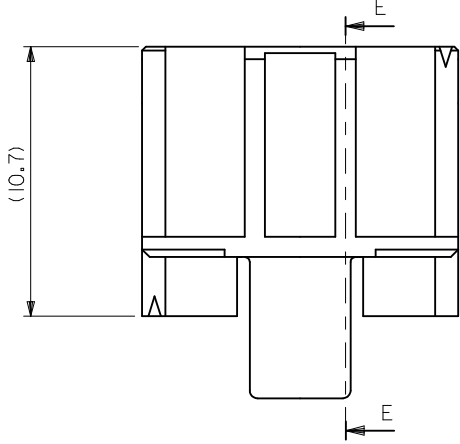
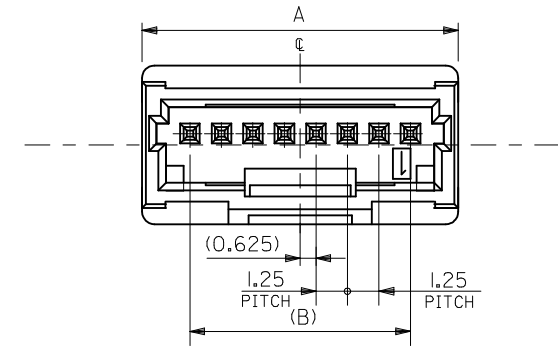

MA中継コネクタ挿入方向
ED & MOUNTED CONNECTOR

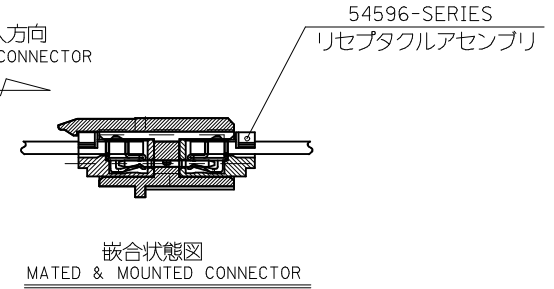

- 注記 1.材質 MATERIAL
 NOTES ウエハー: ポリアミド、UL94-V0、ナチュラル色
 WAFER: PA、UL94-V0、COLOR NATURAL
 ピン: 黄銅、銅下地 錫メッキ
 PIN: BRASS, PRE-TINNED
- 2.嵌合相手 MATE WITH
 リセプタクルアセンブリ: 54596 シリーズ
 REC. ASS'Y: 54596 SERIES
 ピン: リン青銅、錫メッキ
 PIN: PHOSPHOR BRONZE, PRE-TINNED
- 3.本製品は 55482-***30 の鉛フリー品である。
 THIS PRODUCT IS LEAD FREE OF 55482-***30.
- 4.ELV AND RoHS COMPLIANT.

23.75	27.55	55482-2039	20
22.5	26.3	55482-1939	19
21.25	25.05	55482-1839	18
20	23.8	55482-1739	17
18.75	22.55	55482-1639	16
17.5	21.3	55482-1539	15
16.25	20.05	55482-1439	14
15	18.8	55482-1339	13
13.75	17.55	55482-1239	12
12.5	16.3	55482-1139	11
11.25	15.05	55482-1039	10
10	13.8	55482-0939	9
8.75	12.55	55482-0839	8
7.5	11.3	55482-0739	7
6.25	10.05	55482-0639	6
5	8.8	55482-0539	5
3.75	7.55	55482-0439	4
2.5	6.3	55482-0339	3
1.25	5.05	55482-0239	2
B	A	TRAY	CIRCUITS

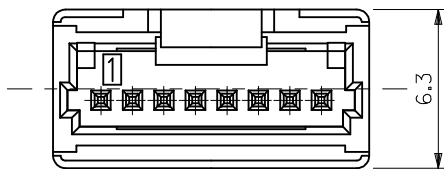

REVISED EC NO: J2010-0170 2009/07/27 DRWN:TKON 2009/07/28 CHKD:KASAKAWA 2009/07/28 APPR:NUKITA 2009/07/29	DESCRIPTION	GENERAL TOLERANCES (UNLESS SPECIFIED)		55482-***39		MODEL NO.	ORDER NO. オーダー番号	
		10 UNDER ±0.2		DIMENSION STYLE MM ONLY		SCALE 5:1	DESIGN UNITS METRIC	
		10 OVER 30 UNDER ±0.25		DRAWN BY T. UENO		THIRD ANGLE PROJECTION		
		30 OVER ±0.3		DATE 2004/06/07		TITLE MINI MI2 1-ROW RELAY WAFER ASSY -LEAD FREE-		
ANGULAR ±3 °		CHECKED BY M. SASAO		DATE 2004/06/07		MOLEX INCORPORATED		
DRAFT WHERE APPLICABLE MUST REMAIN WITHIN DIMENSIONS		APPROVED BY M. SASAO		DATE 2004/06/07		DOCUMENT NO. SD-55482-005	SHEET NO. 1 OF 1	
SIZE A3		THIS DRAWING CONTAINS INFORMATION THAT IS PROPRIETARY TO MOLEX INCORPORATED AND SHOULD NOT BE USED WITHOUT WRITTEN PERMISSION						