

19.5 dB Bi-Directional Coupler

0.5 - 400 MHz

CH-/CHS-137

V2.00

Features

- Low Cost
- Convenient Plug-In Mounting
- Fully Hermetic Package (CHS-137)

Guaranteed Specifications* (From -55°C to +85°C)

Frequency Range	0.5-400 MHz	
Coupling (Input to Output)		
0.5-200 MHz	19.5 ±0.5 dB	
200-400 MHz	20 ±1.0 dB	
VSWR (All Ports)		
5-200 MHz	1.2:1 Max	
0.5-400 MHz	1.5:1 Max	
Directivity (Both Directions)		
0.5-50 MHz	30 dB Min	
50-200 MHz	20 dB Min	
200-400 MHz	15 dB Min	
Main Line Loss**	CH-137	CHS-137
0.5-50 MHz	0.5 dB Max	0.5 dB Max
50-200 MHz	0.4 dB Max	0.4 dB Max
200-400 MHz	0.6 dB Max	0.7 dB Max

RH-1

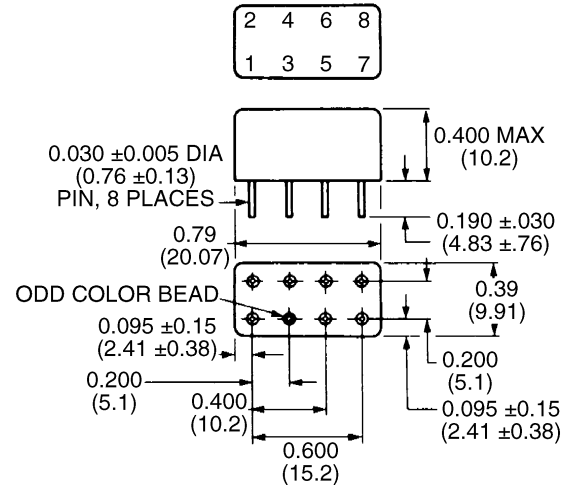

Dimensions in () are in mm.
Unless otherwise noted: .xxx = ±0.010 (.xx = ±0.25)
WEIGHT (APPROX.): 0.23 OUNCES 6.5 GRAMS

Operating Characteristics

Input Power 3.0 Watts Max

Environmental

MIL-STD-202 screening option available.

* All specifications apply with 50 ohm source and load impedance.

** Includes theoretical power split.

Ordering Information

Model No.

CH-137 PIN

CHS-137 PIN

Package

Relay Header

Surface Mount

SF-1

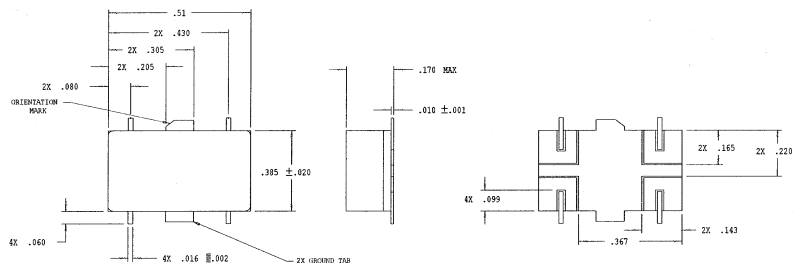

Dimensions in () are in mm.
Unless otherwise noted: .xxx = ±0.010 (.xx = ±0.25)
WEIGHT (APPROX.): 0.07 OUNCES 2 GRAMS

Typical Performance

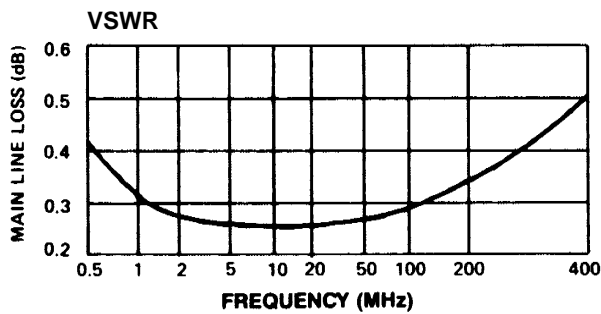
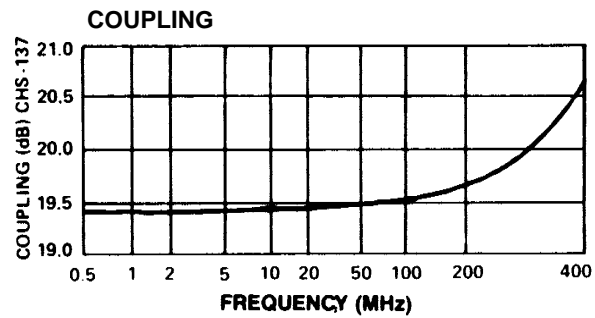
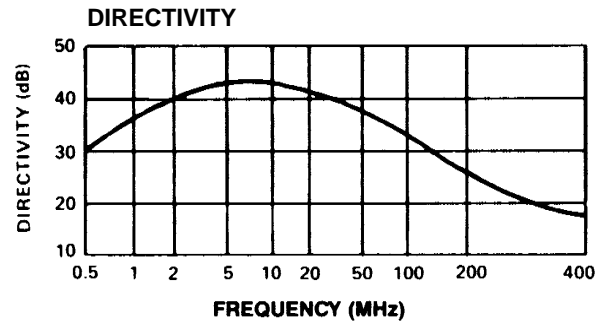
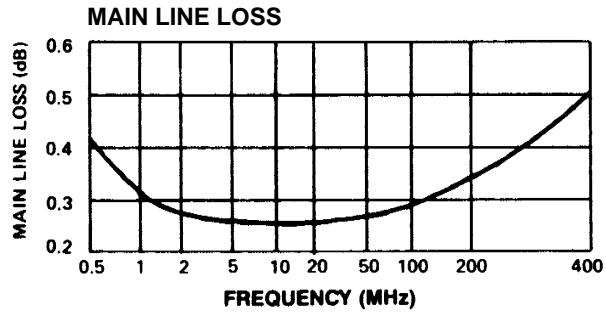

Functional Diagram & Pin Configuration (CH-137)

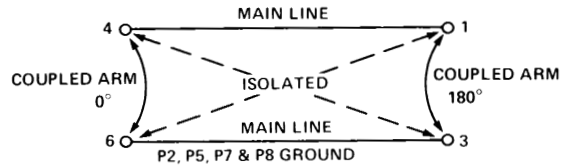

Functional Diagram (CHS-137)

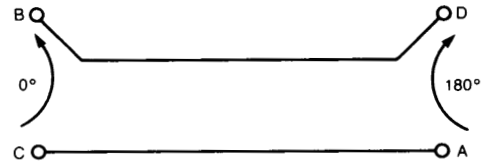

Pin Configuration

CHS-137

Pin Number	Description
1	C
2	B
3	A
4	D