

MECHANICAL DATA

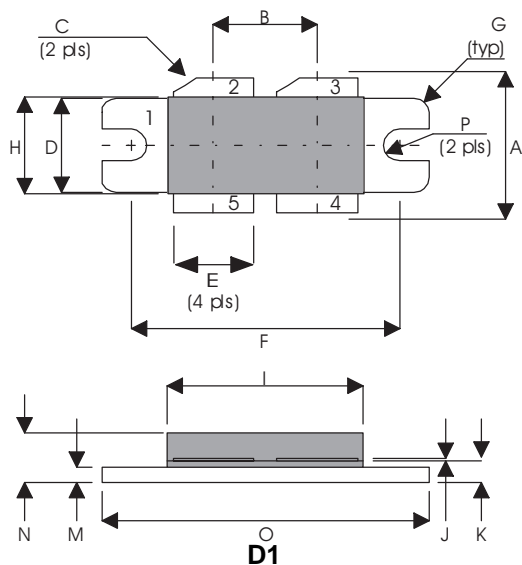

PIN 1	SOURCE (COMMON)	PIN 2	DRAIN 1
PIN 3	DRAIN 2	PIN 4	GATE 2
PIN 5	GATE 1		

DIM	Millimetres	Tol.	Inches	Tol.
A	15.24	0.50	0.600	0.020
B	10.80	0.13	0.425	0.005
C	45°	5°	45°	5°
D	9.78	0.13	0.385	0.005
E	8.38	0.13	0.330	0.005
F	27.94	0.13	1.100	0.005
G	1.52R	0.13	0.060R	0.005
H	10.16	0.15	0.400	0.006
I	21.84	0.23	0.860	0.009
J	0.10	0.02	0.004	0.001
K	1.96	0.13	0.077	0.005
M	1.02	0.13	0.040	0.005
N	4.45	0.38	0.175	0.015
O	34.04	0.13	1.340	0.005
P	1.63R	0.13	0.064R	0.005

IMPROVED PERFORMANCE
GOLD METALLISED
SILICON DMOS RF FET
100W – 50V – 500MHz
PUSH-PULL

FEATURES

- SUITABLE FOR BROAD BAND APPLICATIONS
- SIMPLE BIAS CIRCUITS
- ULTRA-LOW THERMAL RESISTANCE
- BeO FREE
- LOW Crss
- HIGH GAIN – 15 dB MINIMUM

APPLICATIONS

- HF/VHF/UHF COMMUNICATIONS
from 1 MHz to 500 MHz

P_D	Power Dissipation	500W (290W -A Version)
BV_{DSS}	Drain – Source Breakdown Voltage *	125V
BV_{GSS}	Gate – Source Breakdown Voltage *	±20V
$I_{D(sat)}$	Drain Current *	9A
T_{stg}	Storage Temperature	-65 to 150°C
T_j	Maximum Operating Junction Temperature	200°C

* Per Side

Semelab Plc reserves the right to change test conditions, parameter limits and package dimensions without notice. Information furnished by Semelab is believed to be both accurate and reliable at the time of going to press. However Semelab assumes no responsibility for any errors or omissions discovered in its use. Semelab encourages customers to verify that datasheets are current before placing orders.

ELECTRICAL CHARACTERISTICS (T_{case} = 25°C unless otherwise stated)

Parameter	Test Conditions	Min.	Typ.	Max.	Unit
PER SIDE					
B _V DSS	Drain-Source Breakdown Voltage	V _{GS} = 0	I _D = 100mA	125	V
I _{DSS}	Zero Gate Voltage Drain Current	V _{DS} = 50V	V _{GS} = 0		3 mA
I _{GSS}	Gate Leakage Current	V _{GS} = 20V	V _{DS} = 0		1 μA
V _{GS(th)}	Gate Threshold Voltage*	I _D = 10mA	V _{DS} = V _{GS}	1	7 V
g _{fs}	Forward Transconductance*	V _{DS} = 10V	I _D = 3A	2.4	S
TOTAL DEVICE					
G _{PS}	Common Source Power Gain	P _O = 100W		15	dB
η	Drain Efficiency	V _{DS} = 50V	I _{DQ} = 1.2A	65	%
VSWR	Load Mismatch Tolerance	f = 500MHz		20:1	—
PER SIDE					
C _{iss}	Input Capacitance	V _{DS} = 50V	V _{GS} = -5V f = 1MHz	100	pF
C _{oss}	Output Capacitance	V _{DS} = 50V	V _{GS} = 0 f = 1MHz	45	pF
C _{rss}	Reverse Transfer Capacitance	V _{DS} = 50V	V _{GS} = 0 f = 1MHz	1.5	pF

* Pulse Test: Pulse Duration = 300 μs , Duty Cycle ≤ 2%

THERMAL DATA

R _{THj-case}	Thermal Resistance Junction – Case	Max. 0.35°C / W 0.6°C / W -A Version
-----------------------	------------------------------------	---

Semelab Plc reserves the right to change test conditions, parameter limits and package dimensions without notice. Information furnished by Semelab is believed to be both accurate and reliable at the time of going to press. However Semelab assumes no responsibility for any errors or omissions discovered in its use. Semelab encourages customers to verify that datasheets are current before placing orders.

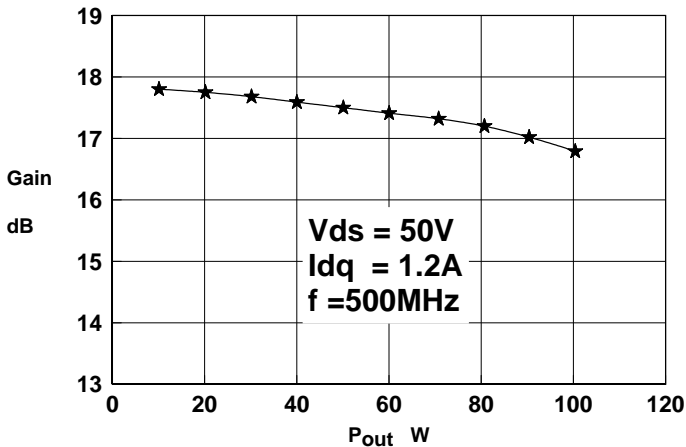

Figure 1 - Gain vs. Power Output.

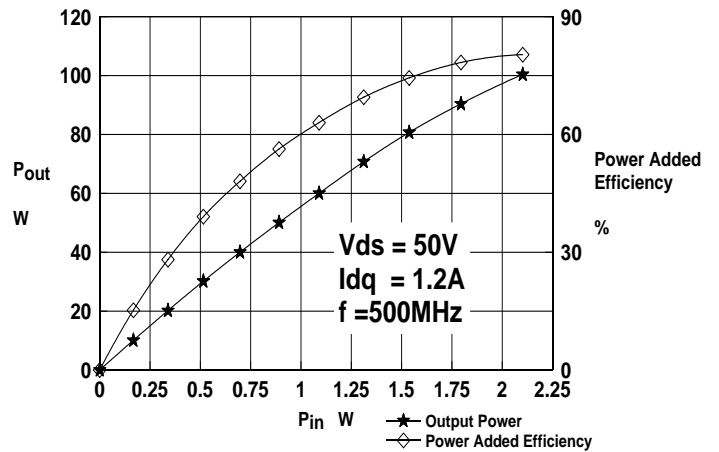

Figure 2 - Power Output & Efficiency vs. Power Input.

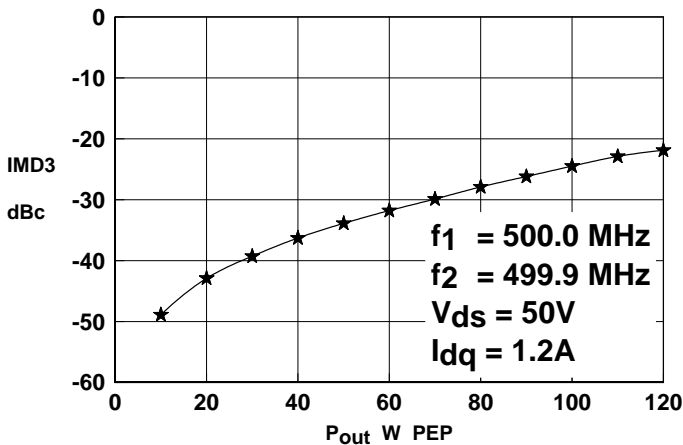

Figure 3 - IMD vs. Output Power.

DMD5012

OPTIMUM SOURCE AND LOAD IMPEDANCE

Frequency MHz	Z_S Ω	Z_L Ω
500	$1.6 + j2.3$	$3.5 + j2.1$

N.B. Impedances measured terminal to terminal

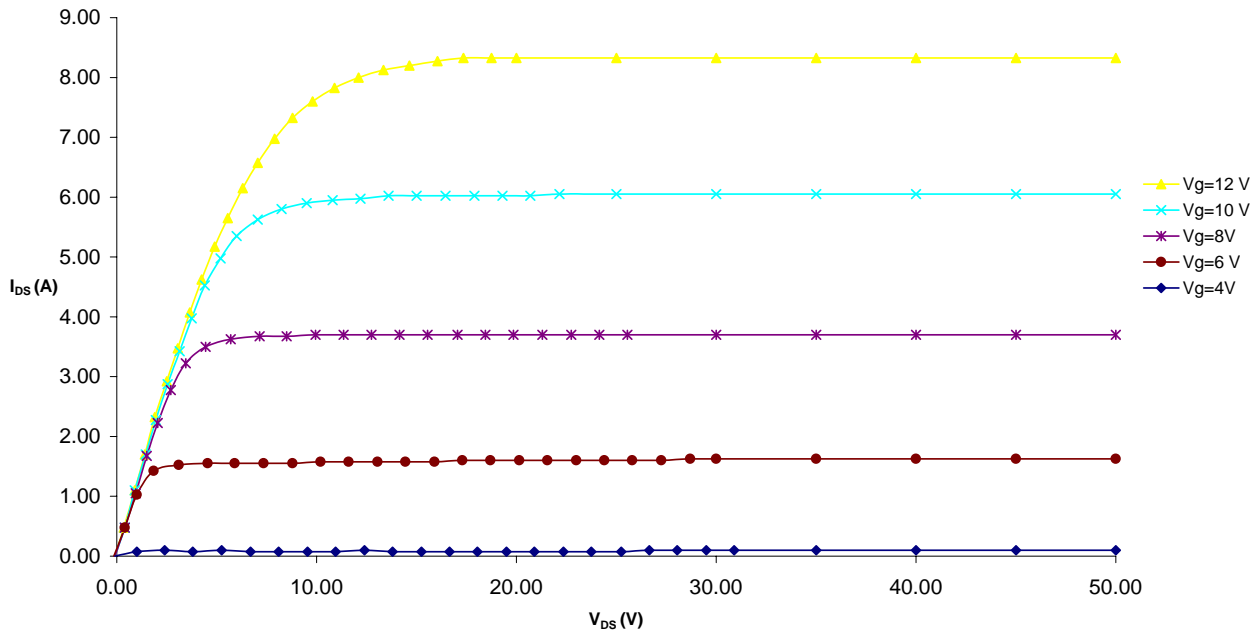

Figure 4 – Typical IV Characteristics.

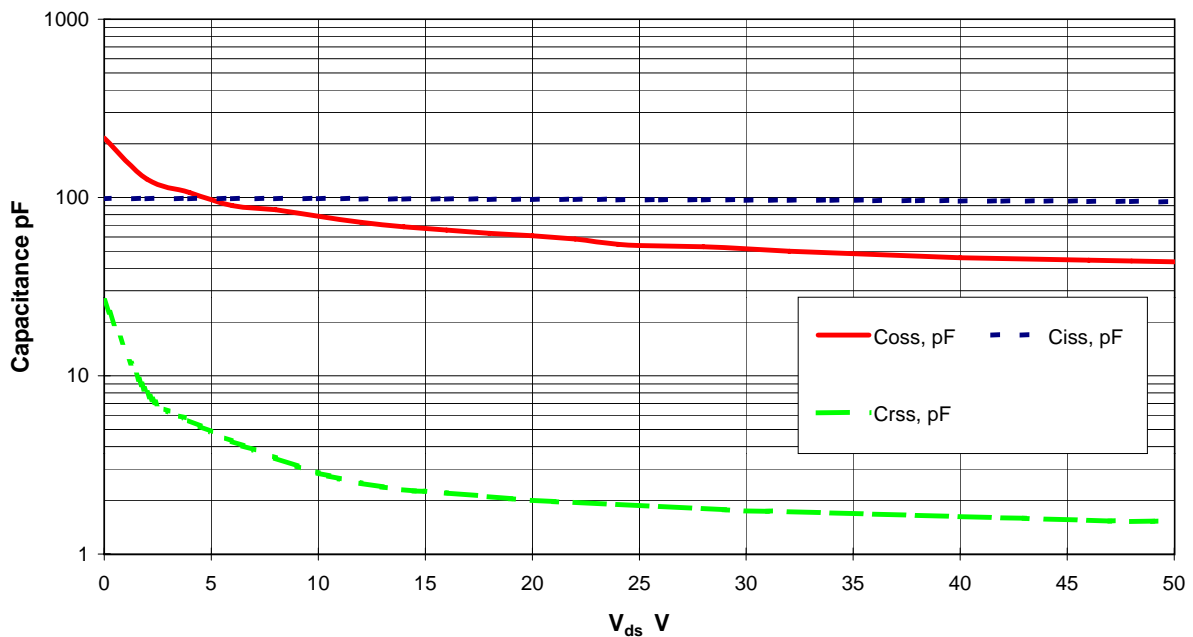
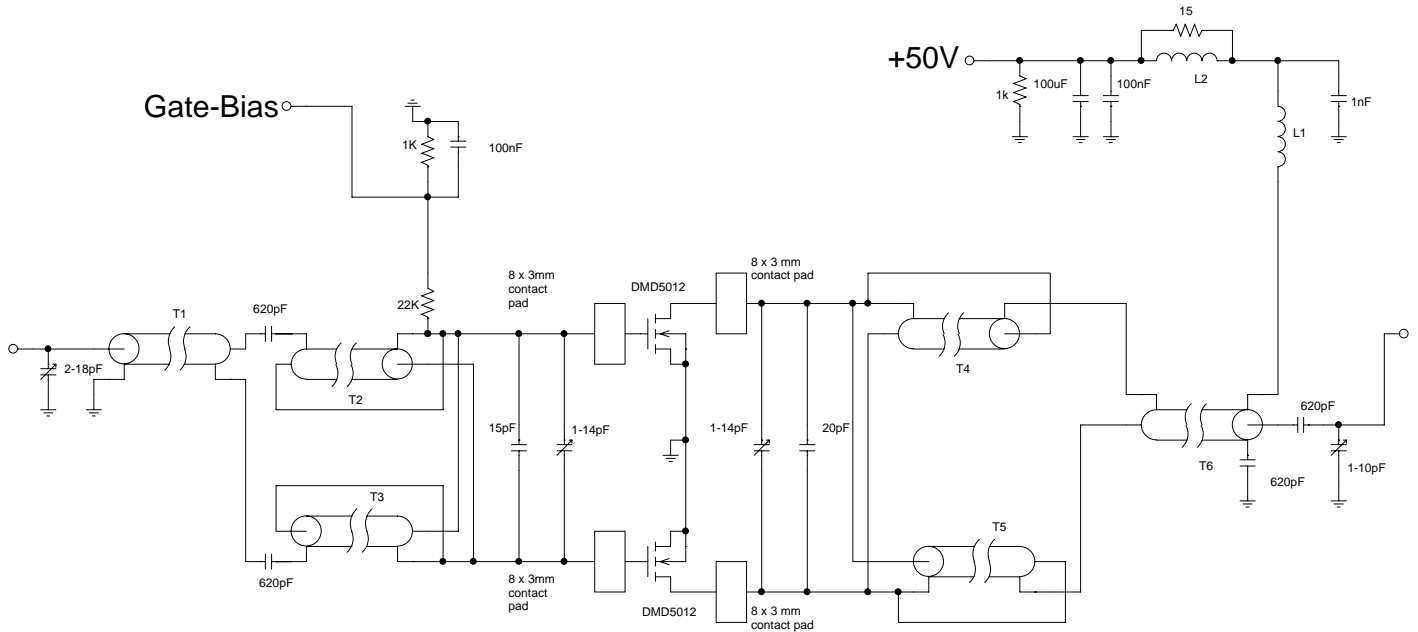

Figure 5 – Typical CV Characteristics.

Semelab Plc reserves the right to change test conditions, parameter limits and package dimensions without notice. Information furnished by Semelab is believed to be both accurate and reliable at the time of going to press. However Semelab assumes no responsibility for any errors or omissions discovered in its use. Semelab encourages customers to verify that datasheets are current before placing orders.



DMD5012 500MHz TEST FIXTURE

T1,6	65mm	50 Ohm UT85 semi-rigid coax
T2,3,4,5	75mm	15 Ohm UT85-15 semi-rigid coax
L1	6 turns	21 swg enamelled copper wire, 3mm i.d.
L2	8.5 turns	19 swg enamelled copper wire on Fair-Rite FT82-43 core