

GSC8107E

P-CHANNEL ENHANCEMENT MODE POWER MOSFET

BVDSS	-30V
RDS(ON)	7.0mΩ
ID	-13A

Description

The GSC8107E provide the designer with the best combination of fast switching, ruggedized device design, low on-resistance and cost-effectiveness.

The SOP-8 package is universally preferred for all commercial-industrial surface mount applications and suited for low voltage applications such as DC/DC converters.

Features

- *Simple Drive Requirement
- *Lower On-resistance
- *Fast Switching Characteristic

Package Dimensions

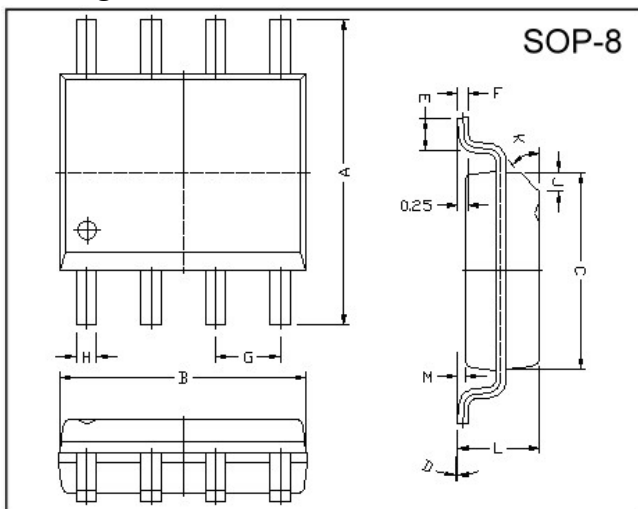

Marking :

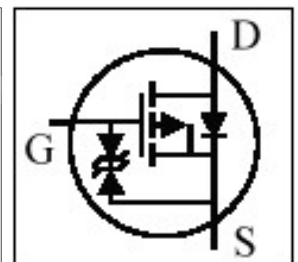
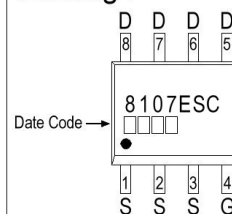

REF.	Millimeter		REF.	Millimeter	
	Min.	Max.		Min.	Max.
A	5.80	6.20	M	0.10	0.25
B	4.80	5.00	H	0.35	0.49
C	3.80	4.00	L	1.35	1.75
D	0°	8°	J	0.375 REF.	
E	0.40	0.90	K	45°	
F	0.19	0.25	G	1.27 TYP.	

Absolute Maximum Ratings

Parameter	Symbol	Ratings	Unit
Drain-Source Voltage	V_{DS}	-30	V
Gate-Source Voltage	V_{GS}	± 20	V
Continuous Drain Current ³	$I_D @ TA=25^\circ C$	-13	A
Continuous Drain Current ³	$I_D @ TA=70^\circ C$	-10	A
Pulsed Drain Current ¹	I_{DM}	-52	A
Total Power Dissipation	$P_D @ TA=25^\circ C$	2.5	W
Linear Derating Factor		0.02	W/°C
Operating Junction and Storage Temperature Range	T_j, T_{stg}	-55 ~ +150	°C

Thermal Data

Parameter	Symbol	Value	Unit
Thermal Resistance Junction-ambient ³ Max.	$R_{thj-amb}$	50	°C/W

Electrical Characteristics (T_j = 25°C unless otherwise specified)

Parameter	Symbol	Min.	Typ.	Max.	Unit	Test Conditions
Drain-Source Breakdown Voltage	BV _{DSS}	-30	-	-	V	V _{GS} =0, I _D =-10mA
Gate Threshold Voltage	V _{GS(th)}	-0.8	-	-2.0	V	V _{DS} =10, I _D =-1mA
Forward Transconductance	g _{fs}	-	31	-	S	V _{DS} =-10V, I _D =-6.5A
Gate-Source Leakage Current	I _{GSS}	-	-	±10	uA	V _{GS} = ±16V
Drain-Source Leakage Current	I _{DSS}	-	-	-10	uA	V _{DS} =-30V, V _{GS} =0
Static Drain-Source On-Resistance ²	R _{DS(ON)}	-	-	7	mΩ	V _{GS} =-10V, I _D =-6.5A
		-	-	15		V _{GS} =-4.5V, I _D =-6.5A
Total Gate Charge ²	Q _g	-	130	-	nC	I _D =-13A V _{DS} =-24V V _{GS} =-10V
Gate-Source Charge	Q _{gs}	-	10	-		
Gate-Drain ("Miller") Charge	Q _{gd}	-	30	-		
Turn-on Delay Time ²	T _{d(on)}	-	22	-	ns	V _{DS} =-15V I _D =-6.5A V _{GS} =-10V R _G =4.7Ω R _L =2.3Ω
Rise Time	T _r	-	11	-		
Turn-off Delay Time	T _{d(off)}	-	395	-		
Fall Time	T _f	-	110	-		
Input Capacitance	C _{iss}	-	5880	-	pF	V _{GS} =0V V _{DS} =-10V f=1.0MHz
Output Capacitance	C _{oss}	-	1000	-		
Reverse Transfer Capacitance	C _{rss}	-	1050	-		

Source-Drain Diode

Parameter	Symbol	Min.	Typ.	Max.	Unit	Test Conditions
Forward On Voltage ²	V _{SD}	-	-	-1.2	V	I _S =-13A, V _{GS} =0V

Notes: 1. Pulse width limited by Max. junction temperature.

2. Pulse width ≤ 300us, duty cycle ≤ 2%.

3. Surface mounted on 1 in² copper pad of FR4 board; 125°C/W when mounted on Min. copper pad.

Characteristics Curve

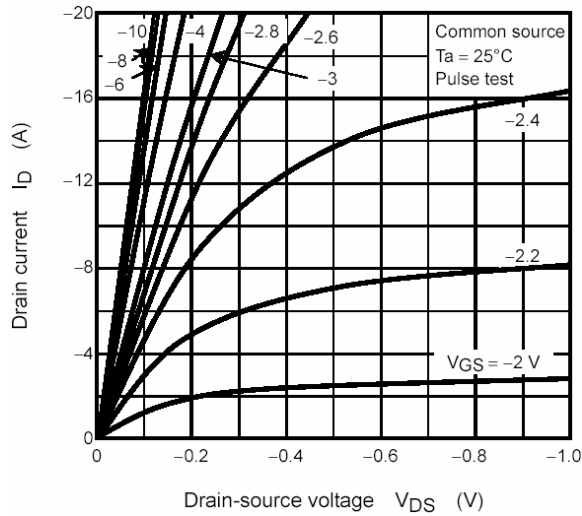

Fig 1. Typical Output Characteristics

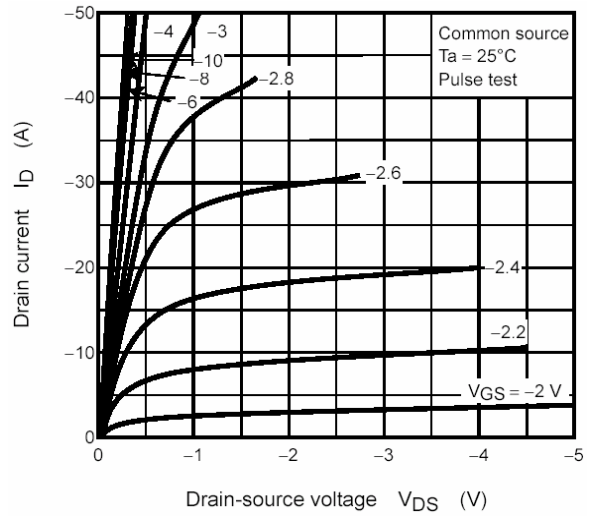

Fig 2. Typical Output Characteristics

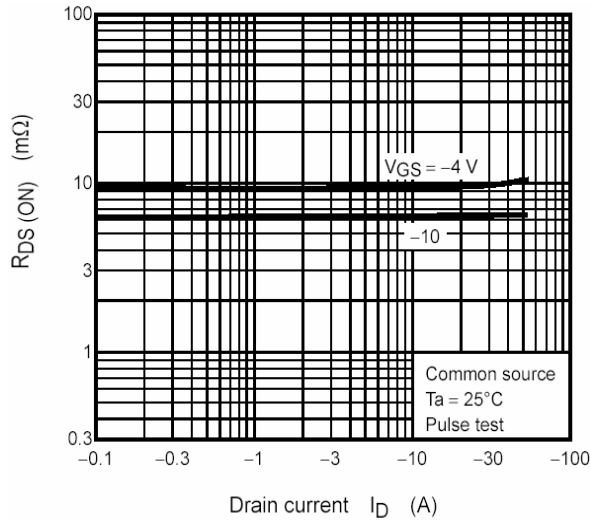

Fig 3. On-Resistance v.s. Drain Current

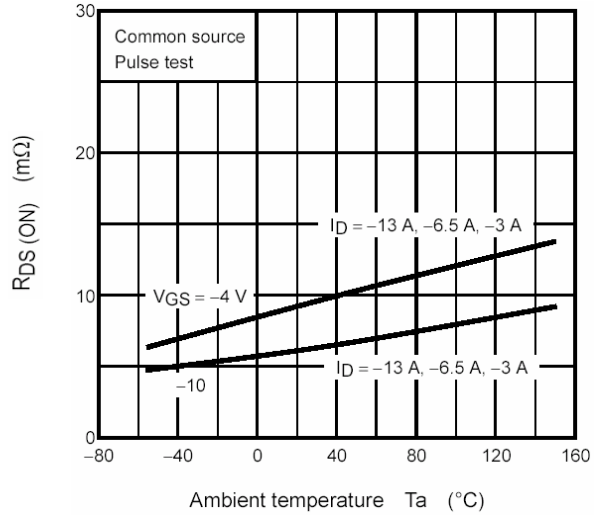

Fig 4. On-Resistance v.s. Ambient Temperature

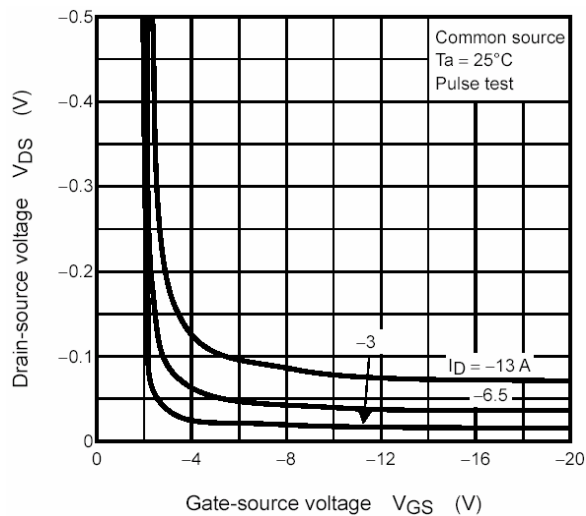

Fig 5. Drain-Source Voltage v.s. Gate-Source Voltage

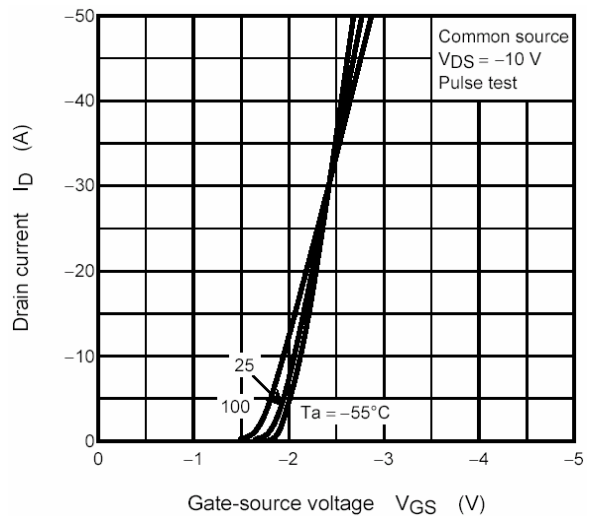

Fig 6. Drain Current v.s. Gate-Source Voltage

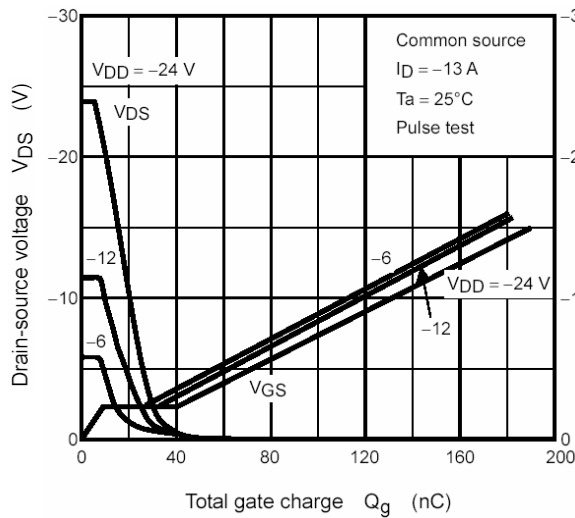

Fig 7. Gate Charge Characteristics

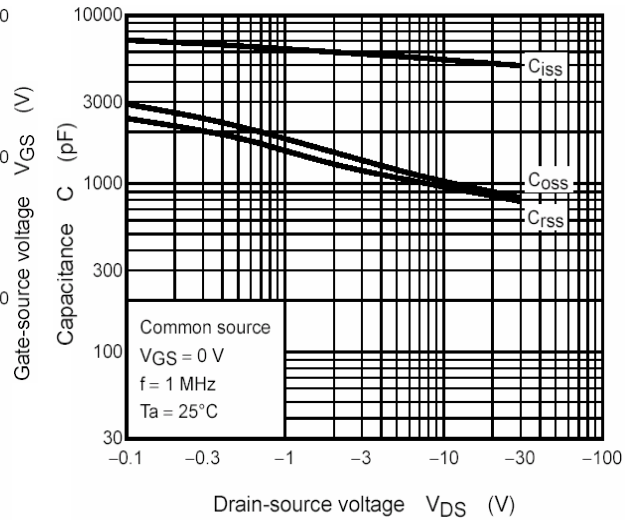

Fig 8. Typical Capacitance Characteristics

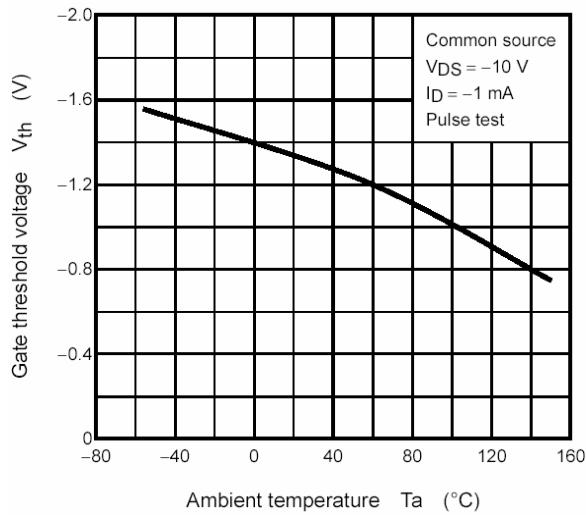

Fig 9. Threshold Voltage

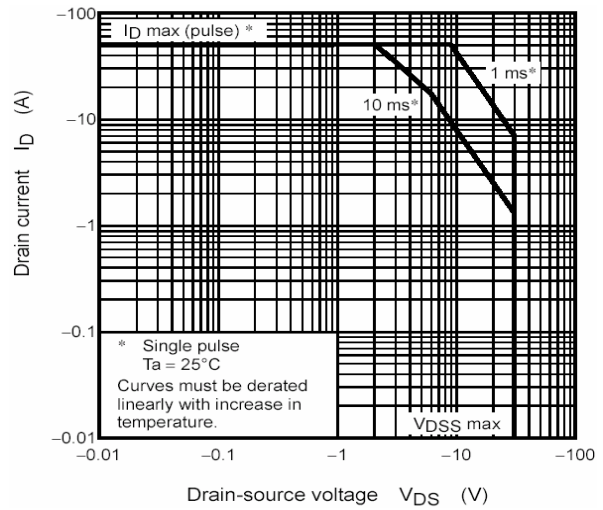

Fig 10. Safe Operating Area

Important Notice:

- All rights are reserved. Reproduction in whole or in part is prohibited without the prior written approval of GTM.
- GTM reserves the right to make changes to its products without notice.
- GTM semiconductor products are not warranted to be suitable for use in life-support Applications, or systems.
- GTM assumes no liability for any consequence of customer product design, infringement of patents, or application assistance.

Head Office And Factory:

- **Taiwan:** No. 17-1 Tatung Rd. Fu Kou Hsin-Chu Industrial Park, Hsin-Chu, Taiwan, R. O. C.
- TEL : 886-3-597-7061 FAX : 886-3-597-9220, 597-0785
- **China:** (201203) No.255, Jang-Jiang Tsai-Lueng RD. , Pu-Dung-Hsin District, Shang-Hai City, China
- TEL : 86-21-5895-7671 ~ 4 FAX : 86-21-38950165