

www.datasheet4u.com

power light source

LUXEON® Flash Module

Introduction

LUXEON® Flash is a family of ultra-compact light sources specifically designed and tested for use as a camera flash in space-constrained, portable digital imaging applications. The LUXEON Flash products are based on proven LUXEON technology and provide the highest levels of light output available for a solid state light source. The uniquely bright source density characteristics of the LUXEON Flash products will provide greater amounts of light where needed, enabling higher resolution pictures to be taken in lower level ambient light environments at greater distances. Camera cell phones, digital still cameras and PDAs can all incorporate LUXEON Flash into sleek designs while maintaining high levels of light output.

Features

- ♦ Highest illuminance per LED on the market
- ♦ Very small emitter size
- ♦ Integrated lens for optimal radiation patterns for Camera Flash
- ♦ Integrated Thermal Solution
- ♦ Rear or Side Mountable
- ♦ Surface Mountable

Benefits

- ♦ High lux and long distances (3m)
- ♦ Enables higher resolution pictures in darker environments
- ♦ Small emitter size allows for smaller overall package size
- ♦ Flexible Integration Options Suitable for Multiple Designs

Typical Applications

- ♦ Wireless camera-phones
- ♦ Digital still cameras

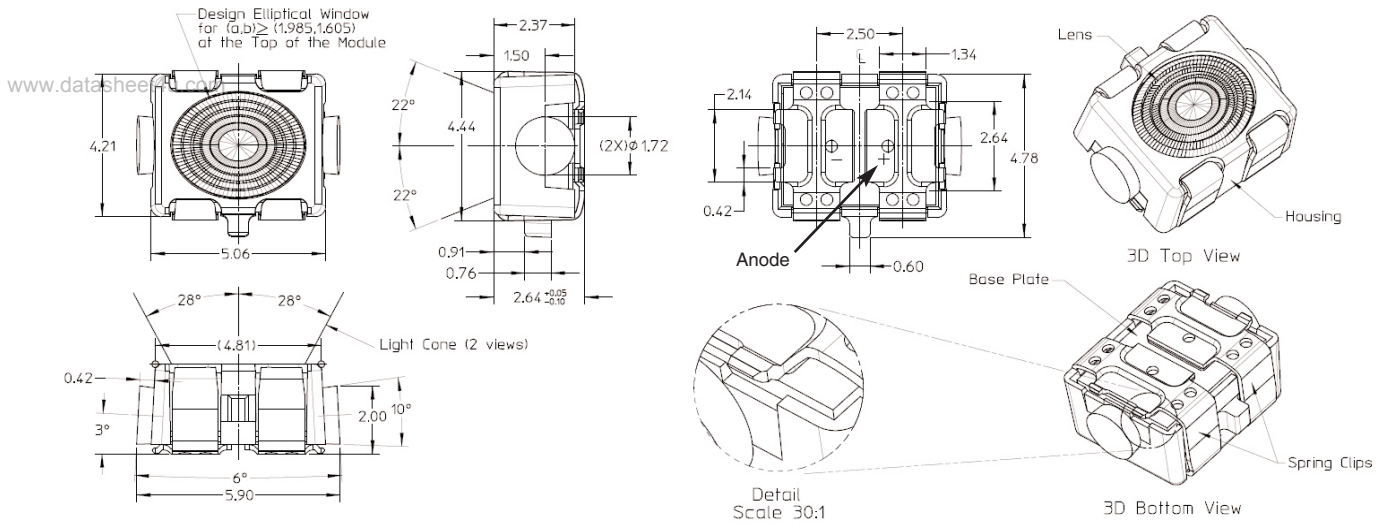

Table of Contents

Mechanical Dimensions	3
Electrical and Optical Characteristics, $T_J = 25^\circ\text{C}$	4
Typical Forward Voltage (V_F) vs. Drive Current (I_F), $T_J = 25^\circ\text{C}$	5
Absolute Maximum Ratings	5
Typical Wavelength Characteristics, $T_J = 25^\circ\text{C}$	6
Derating Curves	7
Typical Change in Color	8
Solder Pad Design	9
Reel Packaging (LXCL-PWM1)	10

Mechanical Dimensions

LXCL-PWM1



All tolerances ± 0.10 unless otherwise specified

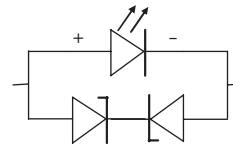

Notes:

1. Drawings not to scale.
3. All dimensions are in millimeters.
4. Measurements without tolerances are for reference only .

Electrical and Optical Characteristics, $T_J = 25^\circ\text{C}$ ^{1, 2, 3, 4, 5, 6}

Table 1.

Part Number	Current (mA)	Parameter	Min.	Typ.	Max.	Units
		Illuminance (at 1m distance)	28	45		lux
		Forward Voltage	3.2	3.8	4.8	V
LXCL-PWM1	1000	Color Temperature	5000	7000	10000	K
		Dynamic Resistance ⁷		0.2		Ω
		Temp Coefficient of Forward Voltage ⁷		-2.0		mV/ $^\circ\text{C}$
		Thermal Resistance, Junction to Case ⁷		10		$^\circ\text{C}/\text{W}$

www.datasheet4u.com

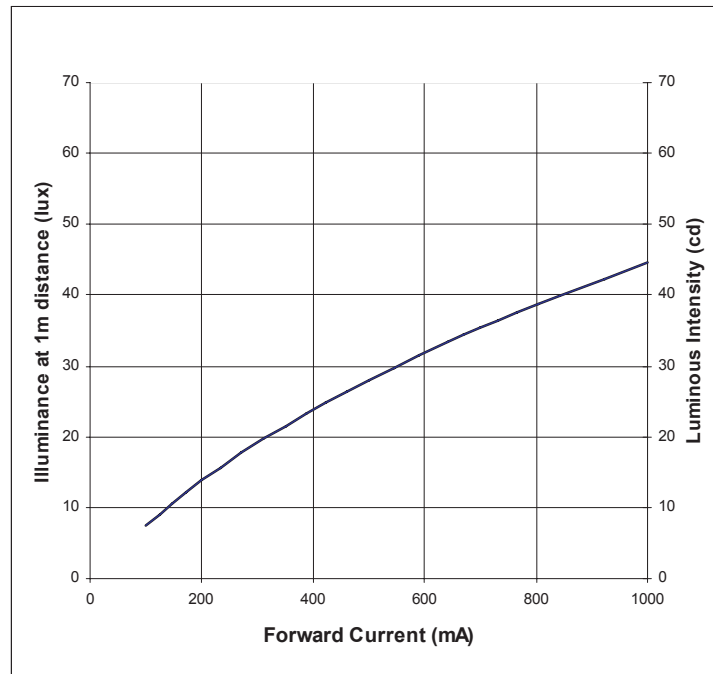

Figure 1. Axial Intensity (cd) and Illuminance (lux) vs. Drive Current, $T_J = 25^\circ\text{C}$

Notes for Table 1 & Figure 1:

1. Minimum illuminance performance guaranteed within published operating conditions. Philips Lumileds maintains a tolerance of 10% on illuminance measurements.
2. LUXEON types with even higher luminous flux levels will become available in the future. Please consult your Philips Lumileds Authorized Distributor or Philips Lumileds sales representative for more information.
3. Philips Lumileds maintains a tolerance of $\pm 0.06\text{V}$ on forward voltage measurements.
4. All values assume a junction temperature T_J of 25°C .
5. For flash modes, it is recommended that the drive current be as high as possible (up to 1000 mA) for optimal results.
6. Dynamic resistance is the inverse of the slope in linear forward voltage model for LEDs.
7. Measured between $25^\circ\text{C} \leq T_J \leq 110^\circ\text{C}$ at $I_F = 1000\text{mA}$.

Typical Forward Voltage (V_F) vs. Drive Current (I_F), $T_J = 25^\circ\text{C}$

www.datasheet4u.com

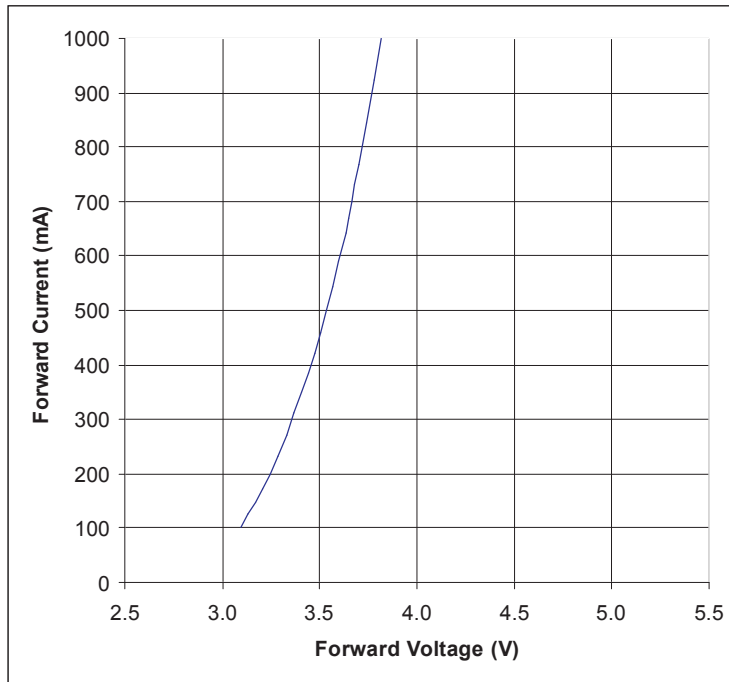

Figure 2. Typical Forward Voltage (V_F) vs. Drive Current (I_F), $T_J = 25^\circ\text{C}$

Absolute Maximum Ratings

Table 2.

Parameter	Value
Max DC Operating Current (mA)	200
Peak Pulsed Forward Current (mA)	1000
ESD Sensitivity ^[1] (volts HBM)	2000
LED Junction Temperature ($^\circ\text{C}$) ^[2]	135
Storage Temperature ($^\circ\text{C}$)	-40 to +120
Reflow Soldering Temperature ($^\circ\text{C}$)	260 for 5 seconds max
Ambient Operating Temperature ($^\circ\text{C}$)	-40 to +85
Moisture Sensitivity Level (JEDEC-STD-020C)	1 - Unlimited floor life (out of bag) at factory ambient

Notes for Table 2:

1. LUXEON Flash Modules are not designed to be driven in reverse bias. Philips Lumileds does not guarantee at reverse bias conditions.
2. Tested in continuous drive mode.

Typical Wavelength Characteristics, $T_J = 25^\circ\text{C}$

www.datasheet4u.com

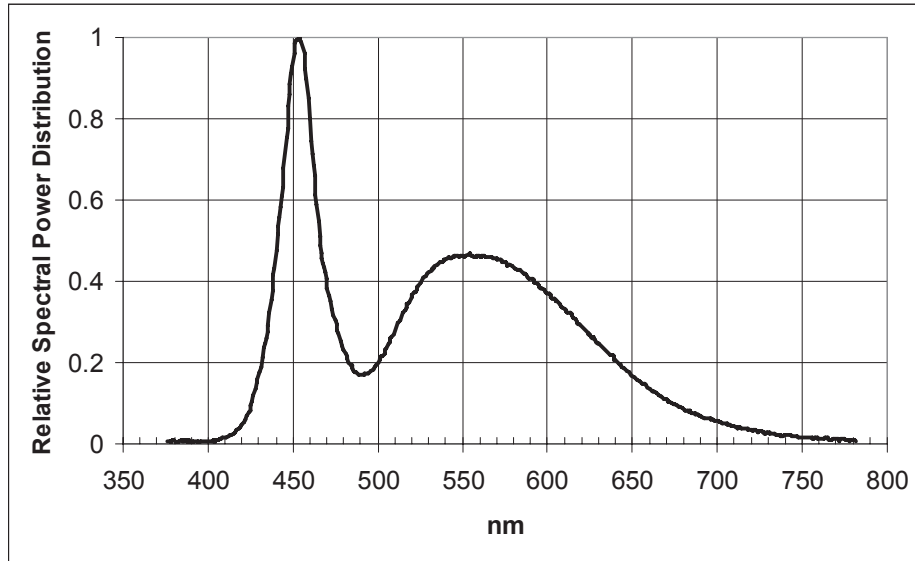

Figure 3. White Color Spectrum of Typical CCT Part, Integrated Measurement.

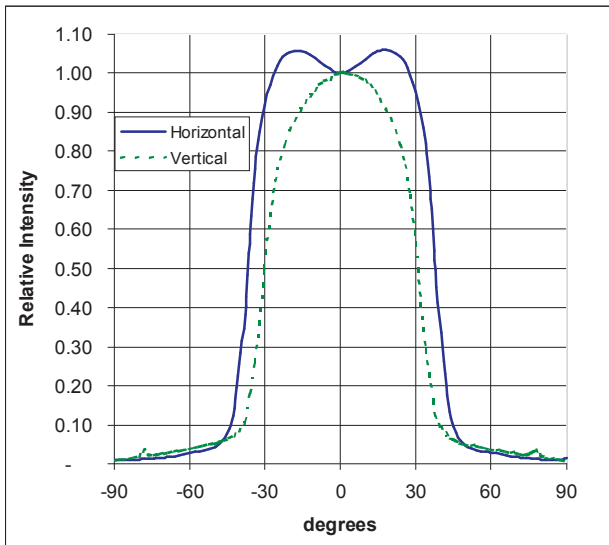

Figure 4. Typical Intensity Distribution.

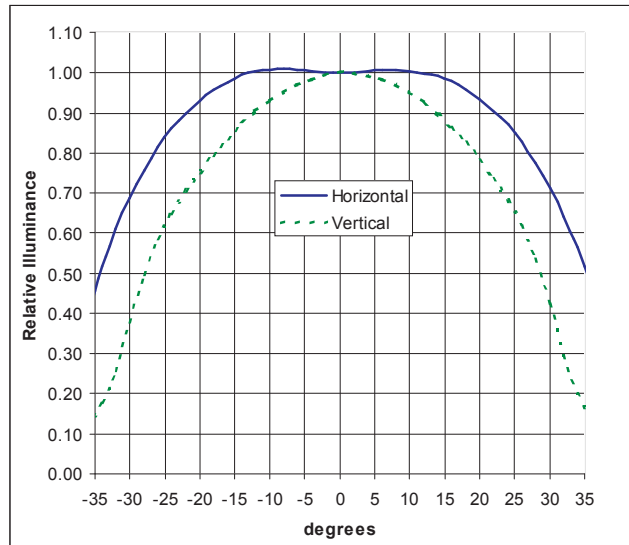
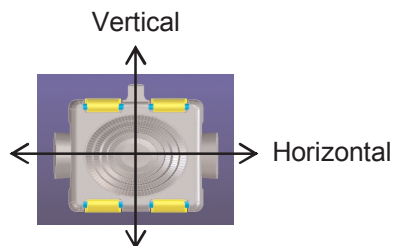

Figure 5. Typical Illuminance Distribution.

Notes for Figures 3, 4 and 5:

1. Illuminance, measured in lux (lumens/m^2), drives the response of camera module.
2. Field of view (FOV) for typical camera module is 56×44 degrees .



Derating Curves

www.datasheet4u.com

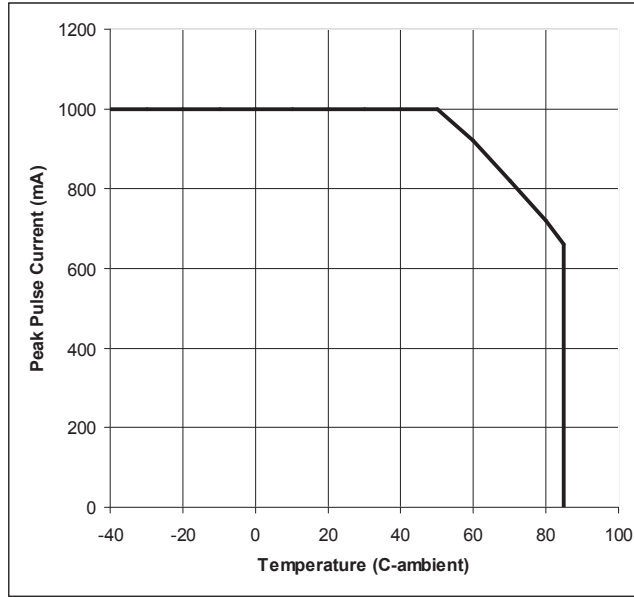

Pulse time < 300 msec

Figure 6a. Pulse Current Derating Curve

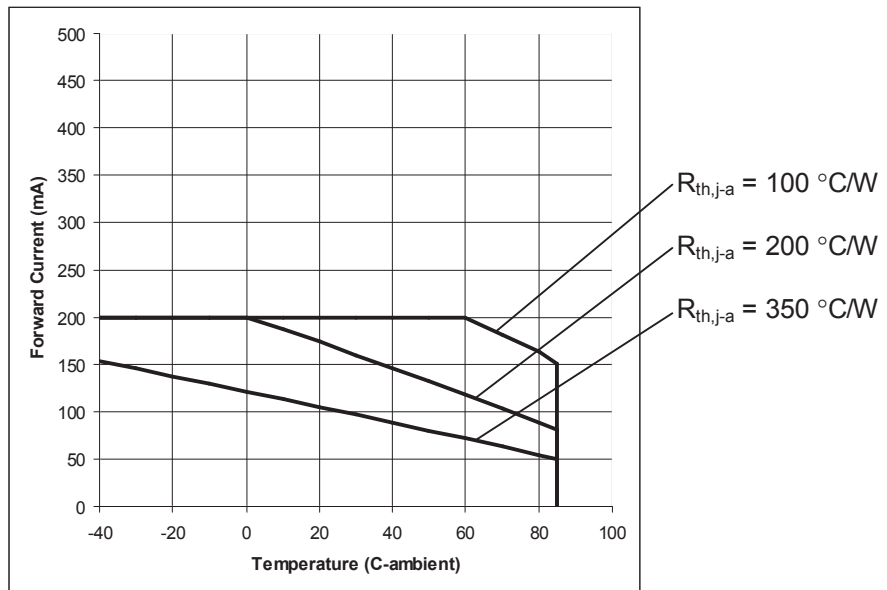

Figure 6b. Forward Current Derating Curve (DC)

Typical Change in Color

www.datasheet4u.com

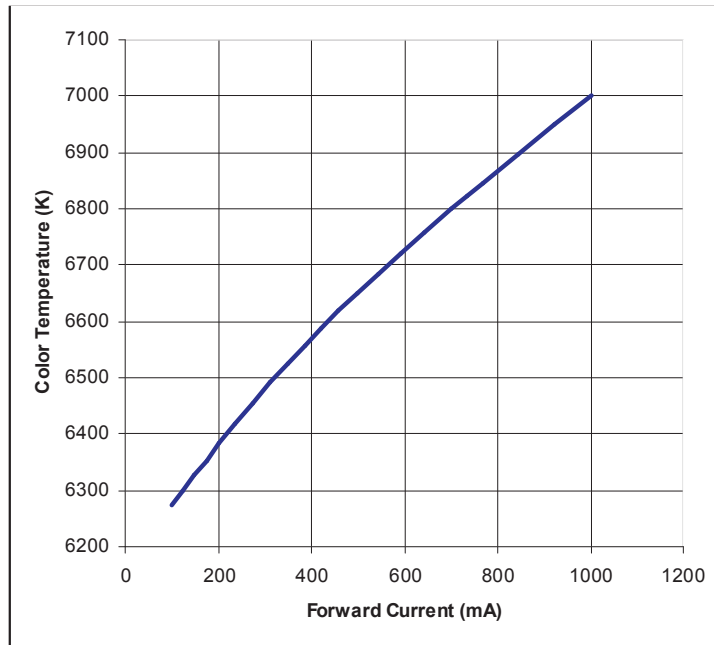

Figure 7. Typical Change in Color vs. Change in Forward Current.

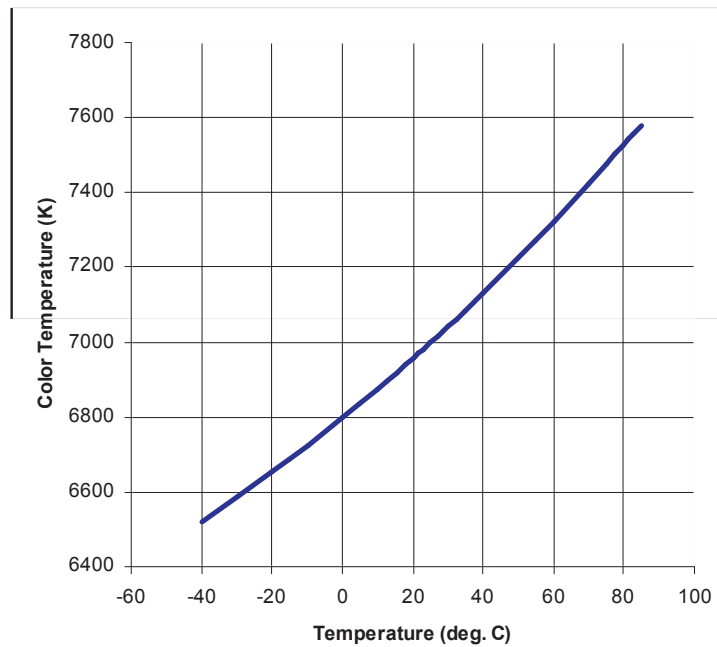

Figure 8. Typical Change in Color vs. Change in Temperature.

Note: Tests performed in pulse mode.

Solder Pad Design

www.datasheet4u.com

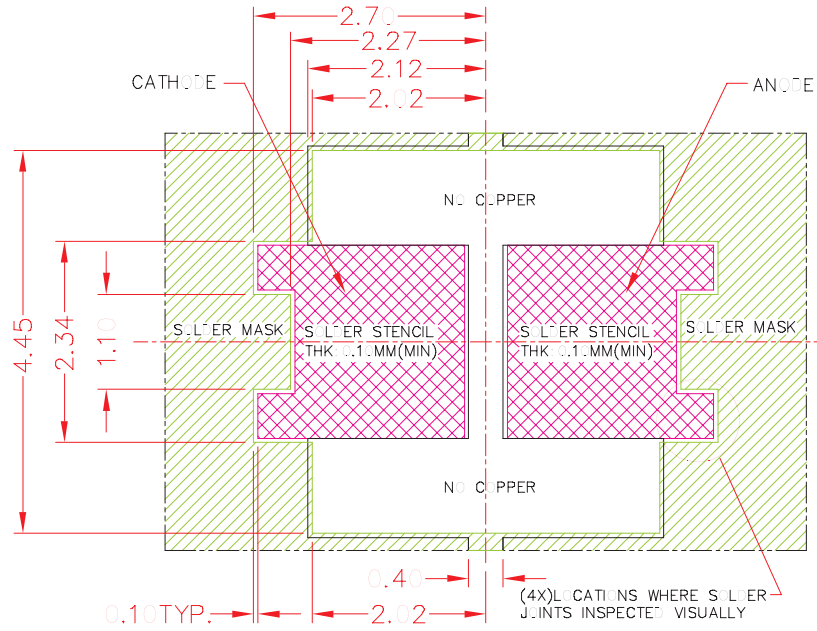
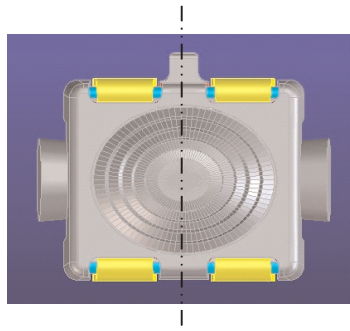

Figure 9. Recommended Solder Pad Design.

Notes for Figure 9:

1. All dimensions are in MM.
2. Tolerance +/-0.05MM.



Relative Part Orientation

Reel Packaging (LXCL-PWM1)

www.datasheet4u.com

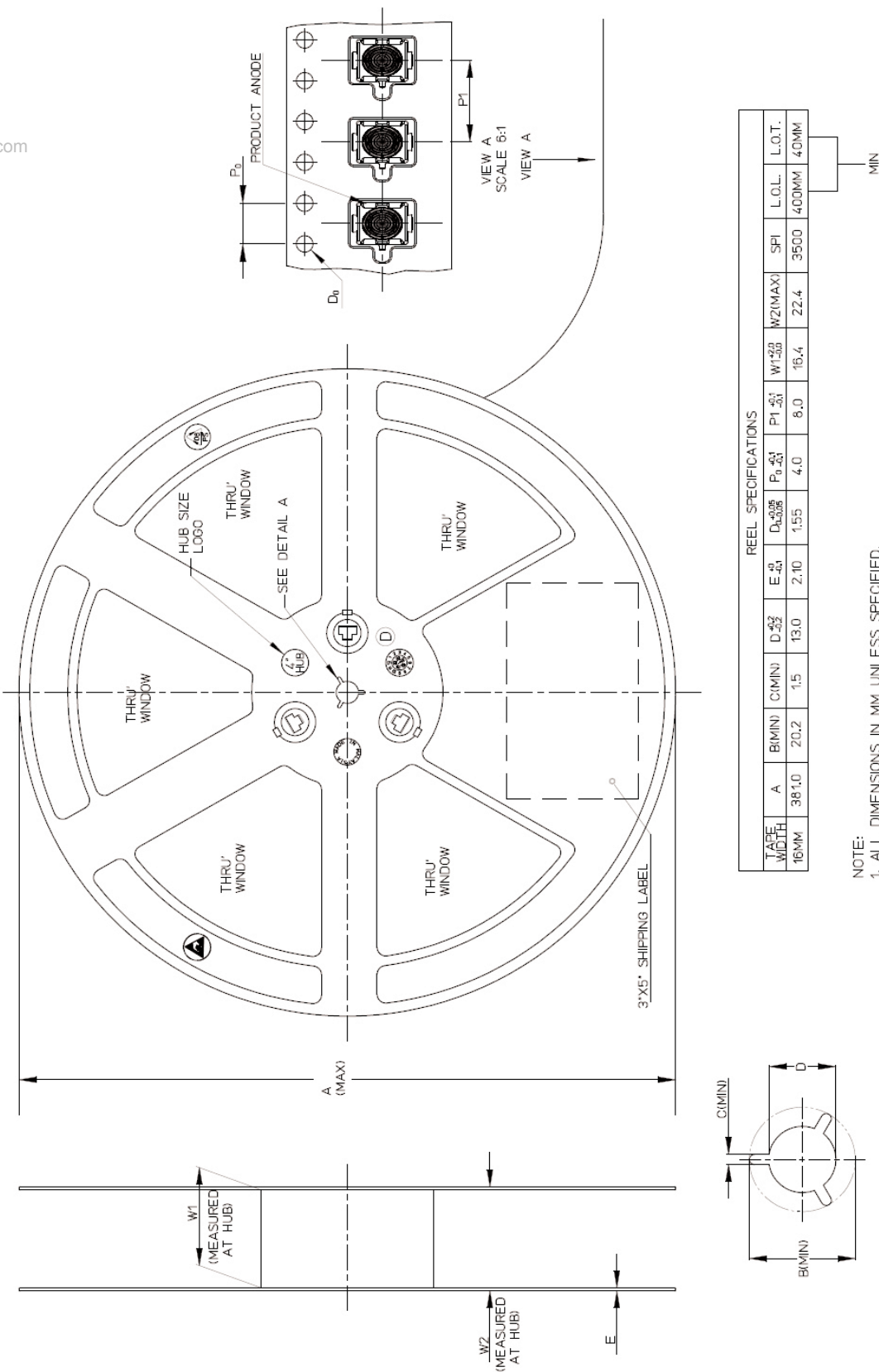

Figure 10. Reel dimensions and orientation.

Company Information

LUXEON®, SuperFlux and SnapLED are developed, manufactured and marketed by Philips Lumileds Lighting Company. Philips Lumileds is a world-class supplier of Light Emitting Diodes (LEDs) producing billions of LEDs annually. Philips Lumileds is a fully integrated supplier, producing core LED material in all three base colors (Red, Green, Blue) and White. Philips Lumileds has R&D centers in San Jose, California and in The Netherlands and production capabilities in San Jose and Penang, Malaysia. Founded in 1999, Philips Lumileds is the high-flux LED technology leader and is dedicated to bridging the gap between solid-state LED technology and the lighting world. Philips Lumileds technology, LEDs and systems are enabling new applications and markets in the lighting world.

Philips Lumileds may make process or materials changes affecting the performance or other characteristics of our products. These products supplied after such changes will continue to meet published specifications, but may not be identical to products supplied as samples or under prior orders.



WWW.LUXEON.COM
WWW.LUMILEDSFUTURE.COM

FOR TECHNICAL ASSISTANCE OR THE
LOCATION OF YOUR NEAREST SALES
OFFICE CONTACT ANY OF THE
FOLLOWING:

NORTH AMERICA:
+1 888 589 3662 OR
ASKLUXEON@FUTUREELECTRONICS.COM

EUROPE:
OO 800 443 88 873 OR
LUXEON.EUROPE@FUTUREELECTRONICS.COM

ASIA:
800 5864 5337 OR
LUMILEDS.ASIA@FUTUREELECTRONICS.COM