



TAI-SAW TECHNOLOGY CO., LTD.

No. 3, Industrial 2nd Rd., Ping-Chen Industrial District,
Taoyuan, 324, Taiwan, R.O.C.

TEL: 886-3-4690038 FAX: 886-3-4697532

E-mail: tstsales@mail.taisaw.com Web: www.taisaw.com

Product Specifications Approval Sheet

Product Description: SAW Filter 403.5 MHz SMD 3.8x3.8 mm

TST Part No.: TA1135A

Customer Part No.: _____

Customer signature required
Company: _____
Division: _____
Approved by : _____
Date: _____

Checked by: _____ David Chang 張閔智

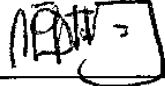
Approved by: _____ Francis Chen 

Date: _____ 2009/11/17

1. Customer signed back is required before TST can proceed with sample build and receive orders.
2. Orders received without customer signed back will be regarded as agreement on the specifications.
3. Any specifications changes must be approved upon by both parties and a new revision of specifications shall be released to reflect the changes.



TAI-SAW TECHNOLOGY CO., LTD.

No. 3, Industrial 2nd Rd., Ping-Chen Industrial District,
Taoyuan, 324, Taiwan, R.O.C.

TEL: 886-3-4690038 FAX: 886-3-4697532

E-mail: tstsales@mail.taisaw.com Web: www.taisaw.com

SAW Filter 403.5 MHz

MODEL NO.: TA1135A

REV. NO.:1

A. MAXIMUM RATING:

1. Input Power Level: 15 dB_m
2. DC voltage: 3 V
3. Operating Temperature: -10°C to 60°C
4. Storage Temperature: -40°C to +85°C

RoHS Compliant
Lead free
Lead-free soldering

B. ELECTRICAL CHARACTERISTICS:

Item		Min.	Typical	Max.
Center frequency	F _c MHz	-	403.5	-
Minimum Insertion loss	402 ~ 405 MHz IL _{min} dB	-	1.5	2.5
Passband Ripple	402 ~ 405 MHz	-	0.3	1.25
3dB Bandwidth	BW _{-3dB} MHz	3	7.6	-
Attenuation (Reference level from IL _{min} dB)				
358.5	MHz dB	40	64	-
358.5~384.0	MHz dB	35	59	-
415.0~423.0	MHz dB	25	36	-
423.0~503.0	MHz dB	40	59	-
Temperature coefficient of frequency	ppm/k		-37	
Source impedance	Z _s Ω	-	50	-
Load impedance	Z _L Ω	-	50	-

Note1: IL_{min} is the minimum of the pass band attenuation. The center frequency F_c is the mean value of the upper and lower frequencies at the 3dB filter attenuation level relative to the IL_{min}.

Note2: The room temperature, Tr, is 25° C. FTC is temperature coefficient of frequency. The nominal frequency at temperature, Tc, may be calculated from $f = F_c [1 - FTC(T_r - T_c)]$.

C. MEASUREMENT CIRCUIT:

HP Network analyzer

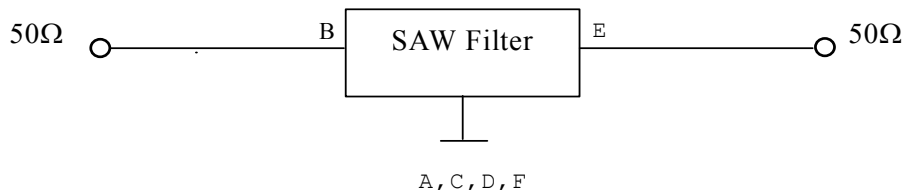

D. Frequency Characteristics:

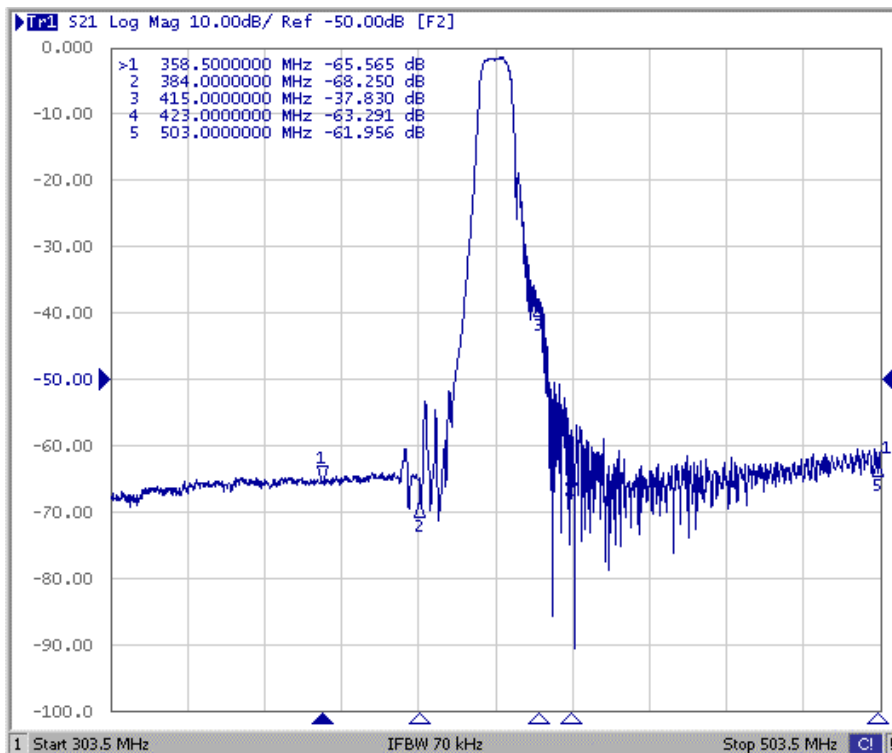
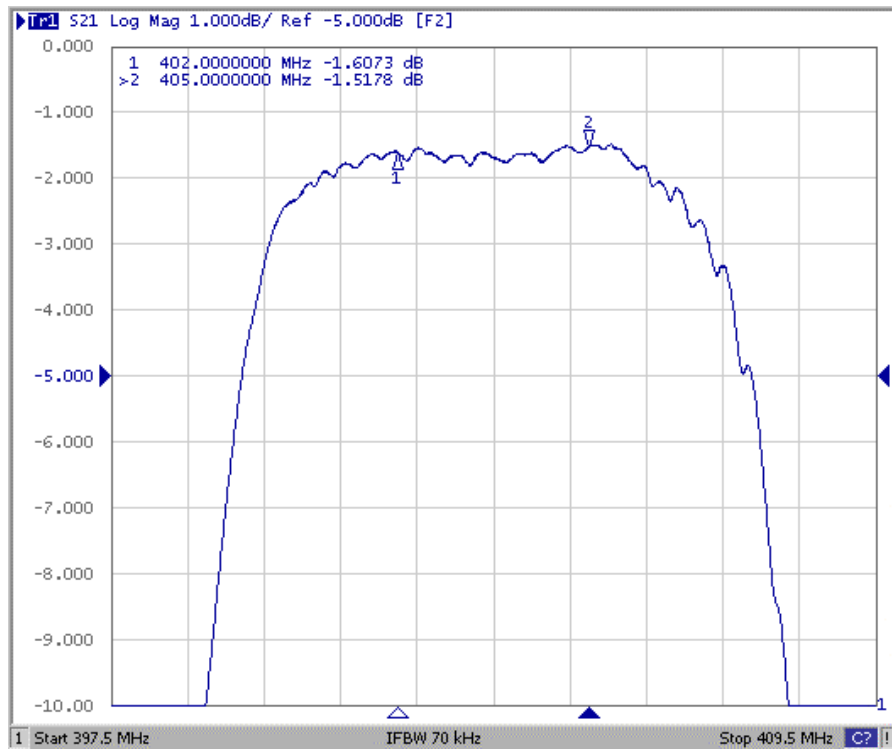

E.OUTLINE DRAWING:

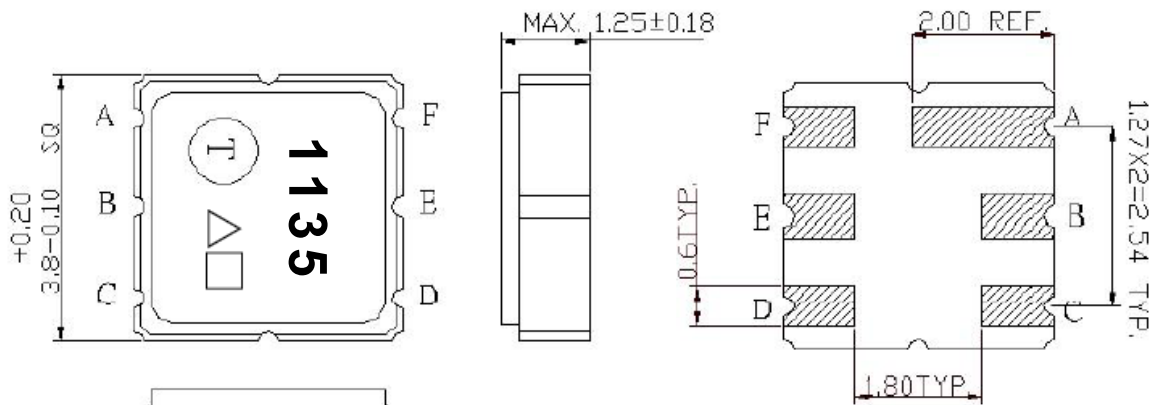

B : Input
 E: Output
 A,C,D,F Ground
 △:Year Code
 □: Date Code(Follow the table provided by planner each year.)
 Unit: mm

△ Product Year Code

Year	2005	2006
	2007	2008
	2009	2010
	.	.
Product Code	A	a

F.PCB FOOTPRINT:

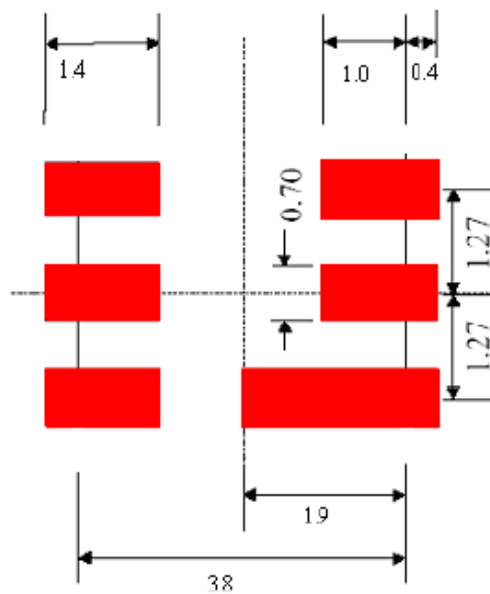

G. PACKING:

1. REEL DIMENSION

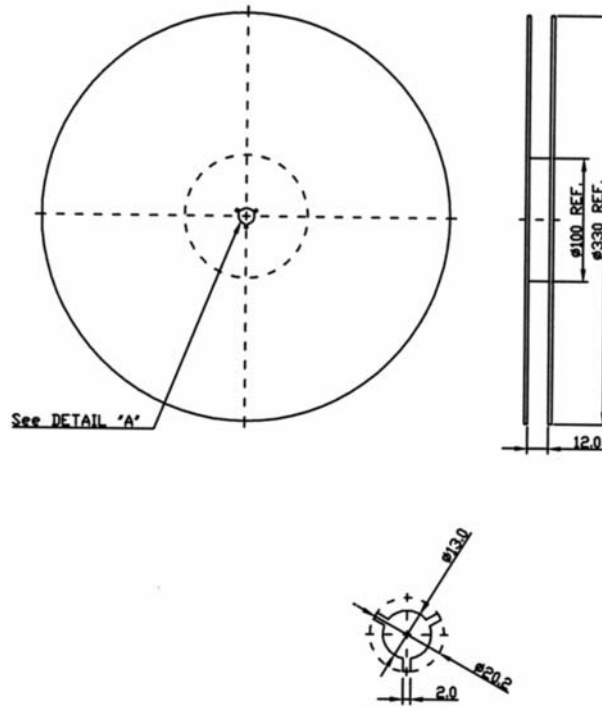

2. TAPE DIMENSION

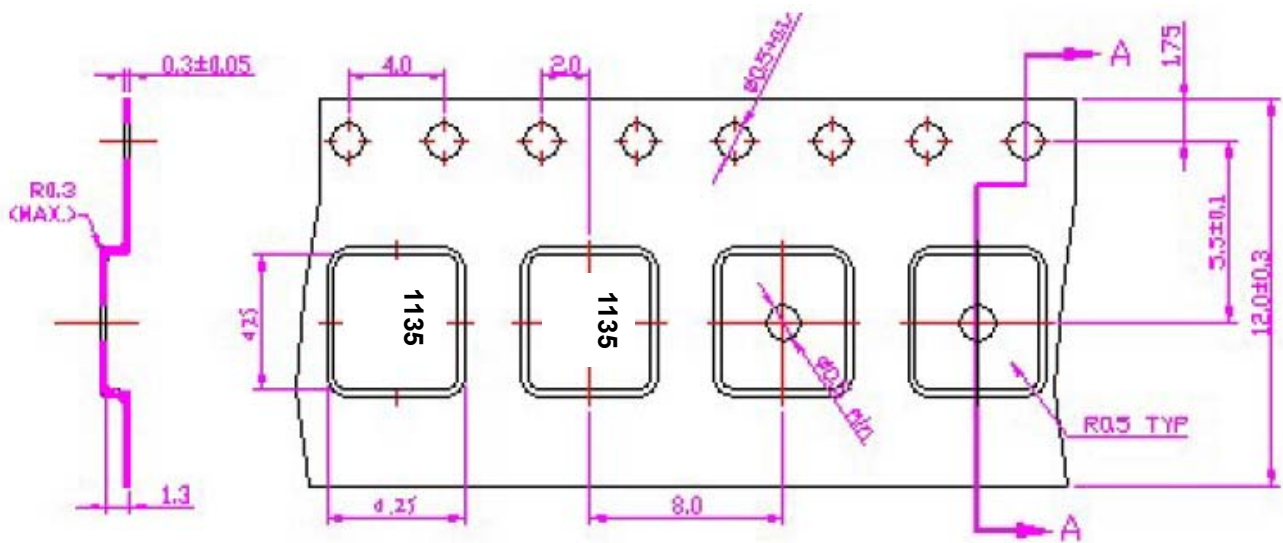

Section A-A

Direction of Feed



H. RECOMMENDED REFLOW PROFILE :

