

Compact high speed thick film thermal printhead (12 dots / mm)

KD3003-DF10A

Using its expertise in LSI technology, ROHM has developed new high density driver chips for use in the KD3003-DF10A. Capable of being employed for both thermal and thermal transfer printing, with a print speed of 200mm/s, the resulting print heads are the fastest in their class. The high-speed and high-density printing answers the needs of ATM, kiosk and ticket printing devices, which are increasingly being called upon to produce graphical output.

●Applications

Label printers
Ticket printers
Terminal printers

●Features

- 1) The use of a special partial glaze and the latest heating element structure, along with new high-density driver chips that can accept big current, has allowed ROHM to achieve print speeds of 200mm/s with using thermal history control, the fastest in its class.
- 2) One rank resistance value of $1000\Omega \pm 3\%$ eliminates the inconvenience of rank selection.
- 3) The required driving voltage of 3.15 to 5.25V allows wide range of power supply voltage setting. This also allows multiple choice of electronic components for printers.
- 4) 2-inch, 3-inch, 4-inch and 8-inch series are available.

●Dimensions (Unit : mm)

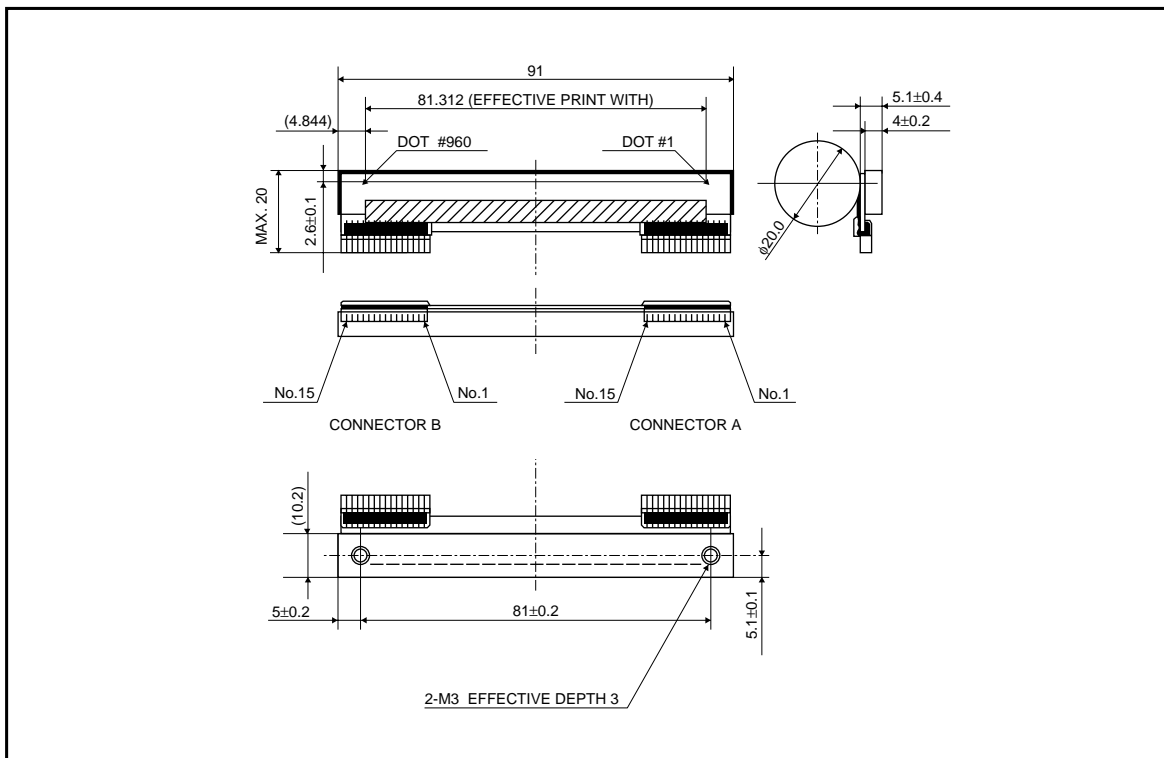

Printheads

●Equivalent circuit

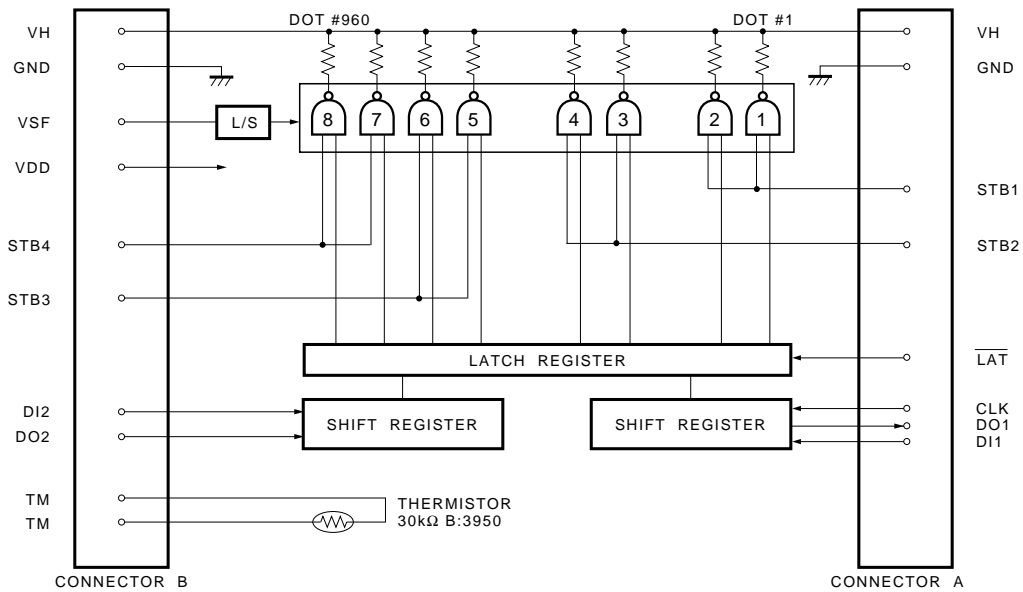

STB No.	Dot No.	dots / STB
1	1 ~ 192	192
2	193 ~ 448	256
3	449 ~ 704	256
4	705 ~ 960	256

DI No.	Dot No.	dots / STB
1	1 ~ 448	448
2	449 ~ 960	512

Fig.1

Printheads

●Pin assignments

CONNECTOR A	
No.	Circuit
1	VH
2	VH
3	VH
4	VH
5	DI1
6	DO1
7	LAT
8	CLK
9	STB1
10	STB2
11	GND
12	GND
13	GND
14	GND
15	GND

CONNECTOR B	
No.	Circuit
1	GND
2	GND
3	GND
4	GND
5	STB3
6	STB4
7	V _{DD}
8	TM
9	TM
10	DO2
11	DI2
12	VSF
13	VH
14	VH
15	VH

●Timing chart

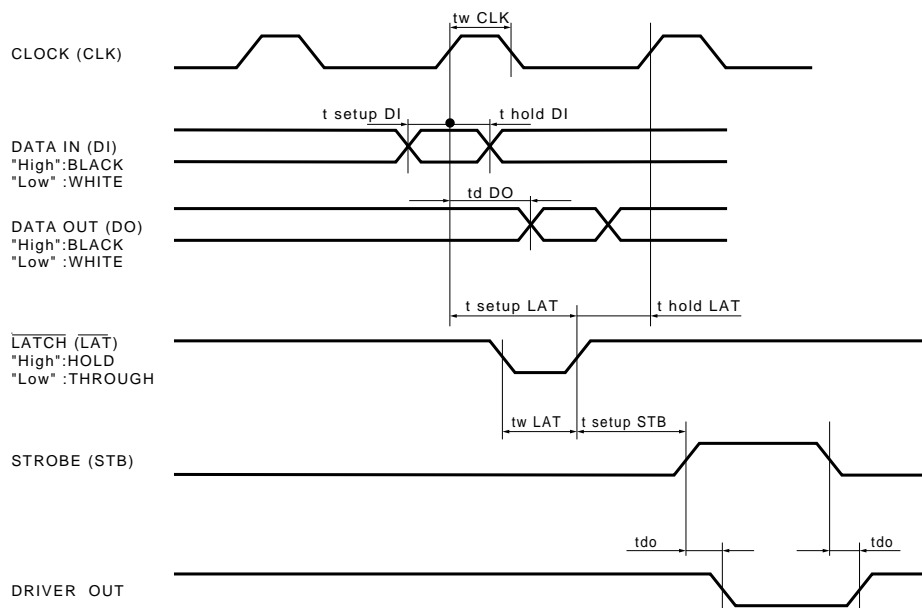

Fig.2

Printheads

●Characteristics

Parameter	Symbol	Typical	Unit
Effective printing width	-	81.312	mm
Dot pitch	-	0.0847	mm
Total dot number	-	960	dots
Average resistance value	Rave	1000	Ω
Applied voltage	V _H	24	V
Applied power	P _O	0.51	W/dot
Print cycle	SLT	0.82	ms
Pulse width	T _{ON}	0.26	ms
Maximum number of dots energized simultaneously	-	512	dots
Maximum clock frequency	-	16	MHz
Maximum roller diameter	-	φ18.0	mm
Running life / pulse life	-	50/5×10 ⁷	km/pulses
Operating temperature	-	5 to 45	°C

●Electrical characteristic curves

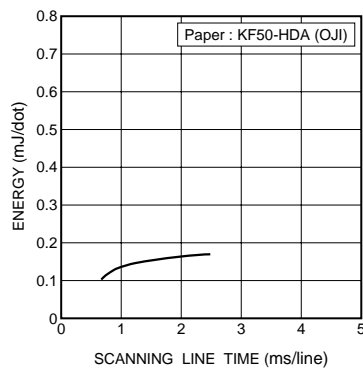

Fig.3 Adaptive speed chart

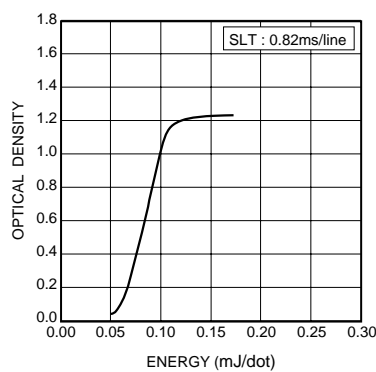

Fig.4 Representative density curve

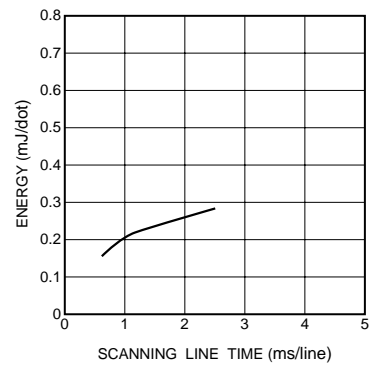

Fig.5 Maximum energy curve

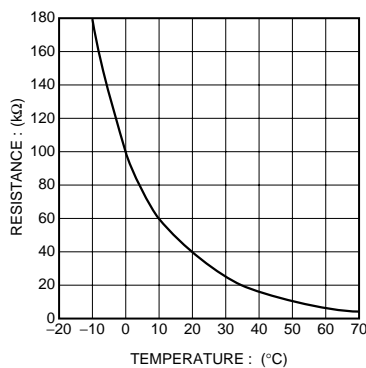

Fig.6 Thermistor curve

Notes

- No technical content pages of this document may be reproduced in any form or transmitted by any means without prior permission of ROHM CO.,LTD.
- The contents described herein are subject to change without notice. The specifications for the product described in this document are for reference only. Upon actual use, therefore, please request that specifications to be separately delivered.
- Application circuit diagrams and circuit constants contained herein are shown as examples of standard use and operation. Please pay careful attention to the peripheral conditions when designing circuits and deciding upon circuit constants in the set.
- Any data, including, but not limited to application circuit diagrams information, described herein are intended only as illustrations of such devices and not as the specifications for such devices. ROHM CO.,LTD. disclaims any warranty that any use of such devices shall be free from infringement of any third party's intellectual property rights or other proprietary rights, and further, assumes no liability of whatsoever nature in the event of any such infringement, or arising from or connected with or related to the use of such devices.
- Upon the sale of any such devices, other than for buyer's right to use such devices itself, resell or otherwise dispose of the same, no express or implied right or license to practice or commercially exploit any intellectual property rights or other proprietary rights owned or controlled by
- ROHM CO., LTD. is granted to any such buyer.
- Products listed in this document are no antiradiation design.

The products listed in this document are designed to be used with ordinary electronic equipment or devices (such as audio visual equipment, office-automation equipment, communications devices, electrical appliances and electronic toys).

Should you intend to use these products with equipment or devices which require an extremely high level of reliability and the malfunction of which would directly endanger human life (such as medical instruments, transportation equipment, aerospace machinery, nuclear-reactor controllers, fuel controllers and other safety devices), please be sure to consult with our sales representative in advance.

It is our top priority to supply products with the utmost quality and reliability. However, there is always a chance of failure due to unexpected factors. Therefore, please take into account the derating characteristics and allow for sufficient safety features, such as extra margin, anti-flammability, and fail-safe measures when designing in order to prevent possible accidents that may result in bodily harm or fire caused by component failure. ROHM cannot be held responsible for any damages arising from the use of the products under conditions out of the range of the specifications or due to non-compliance with the NOTES specified in this catalog.

Thank you for your accessing to ROHM product informations.

More detail product informations and catalogs are available, please contact your nearest sales office.

ROHM Customer Support System

THE AMERICAS / EUROPE / ASIA / JAPAN

www.rohm.com

Contact us : webmaster@rohm.co.jp