

**HEXFET® POWER MOSFET
 SURFACE MOUNT (LCC-28)**

**IRFEA240
 200V, N-CHANNEL**

Product Summary

Part Number	BV _{DSS}	R _{DS(on)}	I _D
IRFEA240	200V	0.18Ω	11A



Fifth Generation HEXFET® power MOSFETs from International Rectifier utilize advanced processing techniques to achieve the lowest possible on-resistance per silicon unit area. This benefit, combined with the fast switching speed and ruggedized device design that HEXFET power MOSFETs are well known for, provides the designer with an extremely efficient device for use in a wide variety of applications.

These devices are well-suited for applications such as switching power supplies, motor controls, inverters, choppers, audio amplifiers and high-energy pulse circuits.

Features:

- Low R_{DS(on)}
- Avalanche Energy Ratings
- Dynamic dv/dt Rating
- Simple Drive Requirements
- Ease of Paralleling
- Hermetically Sealed
- Surface Mount
- Light Weight

Absolute Maximum Ratings

	Parameter		Units
I _D @ V _{GS} = 10V, T _C = 25°C	Continuous Drain Current	11	A
I _D @ V _{GS} = 10V, T _C = 100°C	Continuous Drain Current	7.0	
I _{DM}	Pulsed Drain Current ①	44	
P _D @ T _C = 25°C	Max. Power Dissipation	50	W
	Linear Derating Factor	0.4	W/°C
V _{GS}	Gate-to-Source Voltage	±20	V
EAS	Single Pulse Avalanche Energy ②	80	mJ
I _{AR}	Avalanche Current ①	11	A
EAR	Repetitive Avalanche Energy ①	5.0	mJ
dv/dt	Peak Diode Recovery dv/dt ③	5.0	V/ns
T _J	Operating Junction	-55 to 150	°C
T _{STG}	Storage Temperature Range		
	Package Mounting Surface Temperature	300 (for 5 s)	
	Weight	0.89	g

For footnotes refer to the last page

Electrical Characteristics @ T_j = 25°C (Unless Otherwise Specified)

	Parameter	Min	Typ	Max	Units	Test Conditions
B _V D _{SS}	Drain-to-Source Breakdown Voltage	200	—	—	V	V _{GS} = 0V, I _D = 1mA
ΔB _V D _{SS} /ΔT _J	Temperature Coefficient of Breakdown Voltage	—	0.25	—	V/°C	Reference to 25°C, I _D = 1.0mA
R _{DS(on)}	Static Drain-to-Source On-State Resistance	—	—	0.18	Ω	V _{GS} = 10V, I _D = 11A ④
V _{GS(th)}	Gate Threshold Voltage	2.0	—	4.0	V	V _{DS} = V _{GS} , I _D = 250μA
g _{fs}	Forward Transconductance	6.0	—	—	S (Ω)	V _{DS} = 25V, I _{DS} = 11A ④
I _{DSS}	Zero Gate Voltage Drain Current	—	—	25	μA	V _{DS} = 160V, V _{GS} = 0V
		—	—	250		V _{DS} = 160V, V _{GS} = 0V, T _J = 125°C
I _{GSS}	Gate-to-Source Leakage Forward	—	—	100	nA	V _{GS} = 20V
I _{GSS}	Gate-to-Source Leakage Reverse	—	—	-100		V _{GS} = -20V
Q _g	Total Gate Charge	—	—	84	nC	V _{GS} = 10V, I _D = 11A V _{DS} = 100V
Q _{gs}	Gate-to-Source Charge	—	—	17		
Q _{gd}	Gate-to-Drain ('Miller') Charge	—	—	41		
t _{d(on)}	Turn-On Delay Time	—	—	25	ns	V _{DD} = 100V, I _D = 11A R _G = 9.1Ω
t _r	Rise Time	—	—	196		
t _{d(off)}	Turn-Off Delay Time	—	—	80		
t _f	Fall Time	—	—	130		
L _S + L _D	Total Inductance	—	6.1	—	nH	Measured from the center of drain pad to center of source pad
C _{iss}	Input Capacitance	—	1340	—	pF	V _{GS} = 0V, V _{DS} = 25V f = 1.0MHz
C _{oss}	Output Capacitance	—	434	—		
C _{rss}	Reverse Transfer Capacitance	—	134	—		

Source-Drain Diode Ratings and Characteristics

	Parameter	Min	Typ	Max	Units	Test Conditions
I _S	Continuous Source Current (Body Diode)	—	—	11	A	
I _{SM}	Pulse Source Current (Body Diode) ①	—	—	44		
V _{SD}	Diode Forward Voltage	—	—	1.5	V	T _j = 25°C, I _S = 11A, V _{GS} = 0V ④
t _{rr}	Reverse Recovery Time	—	—	470	nS	T _j = 25°C, I _F = 11A, di/dt ≤ 100A/μs
Q _{RR}	Reverse Recovery Charge	—	—	6.5	μC	V _{DD} ≤ 25V ④
t _{on}	Forward Turn-On Time	Intrinsic turn-on time is negligible. Turn-on speed is substantially controlled by L _S + L _D .				

Thermal Resistance

	Parameter	Min	Typ	Max	Units	Test Conditions
R _{thJC}	Junction-to-Case	—	—	2.5	°C/W	

Note: Corresponding Spice and Saber models are available on the G&S Website.

For footnotes refer to the last page

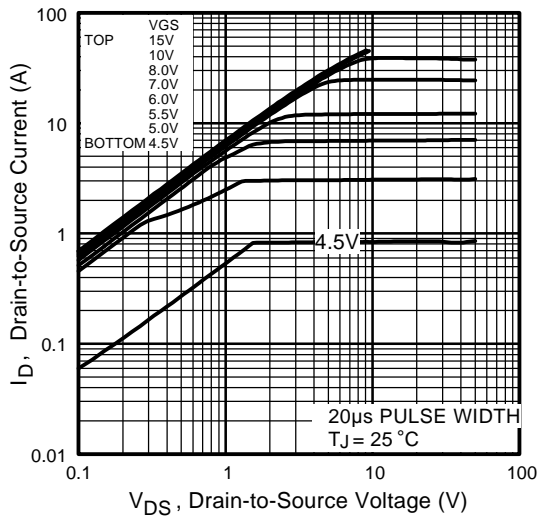

Fig 1. Typical Output Characteristics

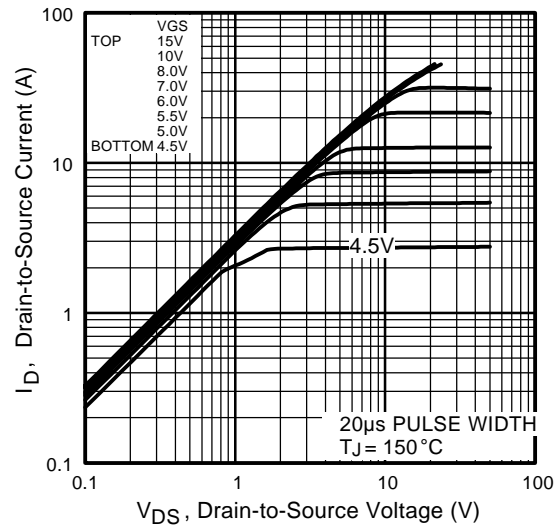

Fig 2. Typical Output Characteristics

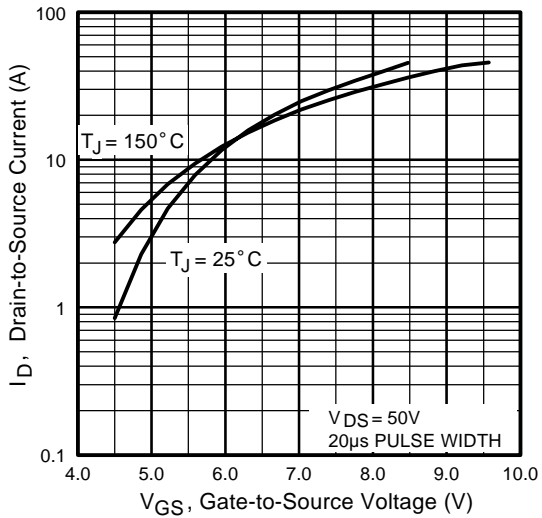

Fig 3. Typical Transfer Characteristics

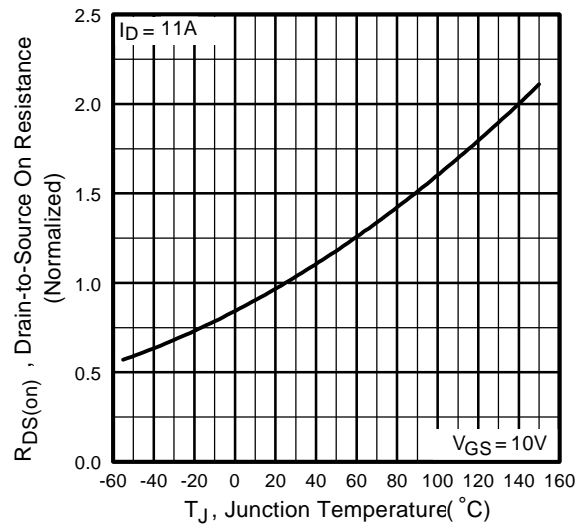

Fig 4. Normalized On-Resistance Vs. Temperature

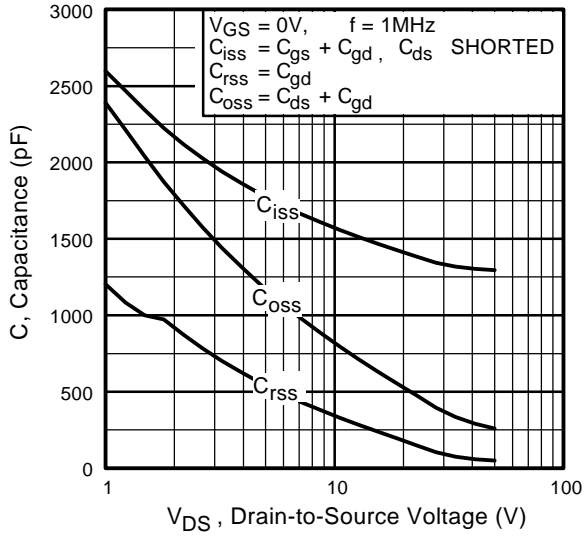

Fig 5. Typical Capacitance Vs. Drain-to-Source Voltage

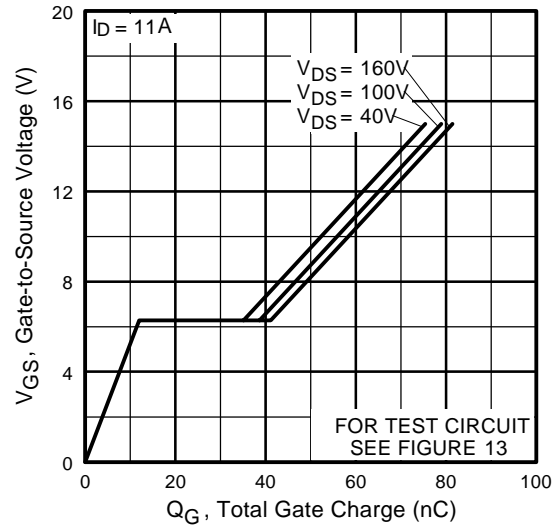

Fig 6. Typical Gate Charge Vs. Gate-to-Source Voltage

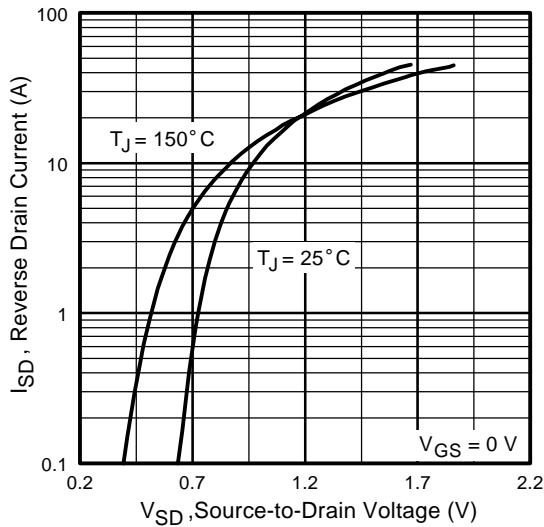

Fig 7. Typical Source-Drain Diode Forward Voltage

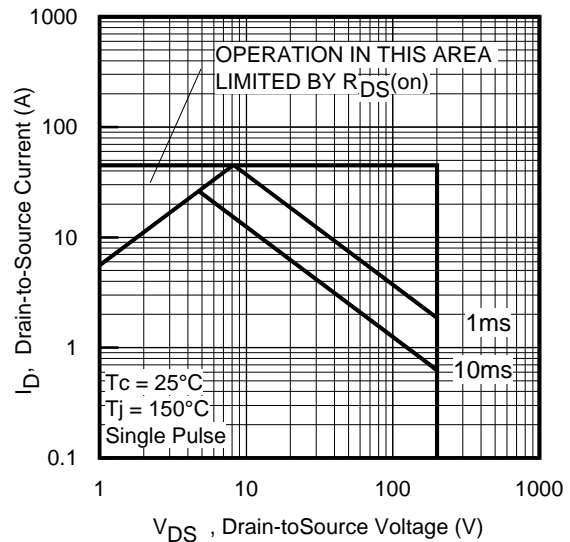

Fig 8. Maximum Safe Operating Area

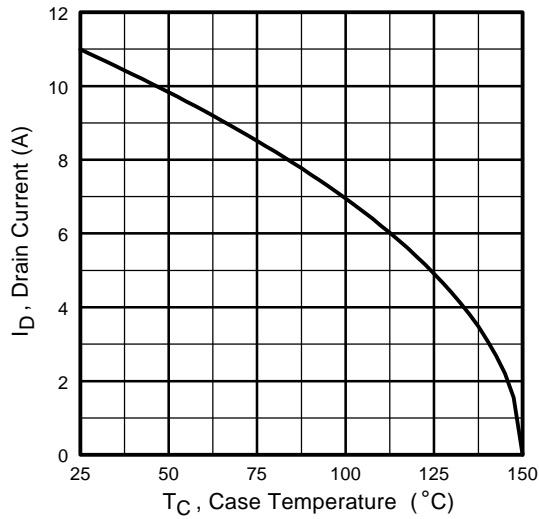

Fig 9. Maximum Drain Current Vs. Case Temperature

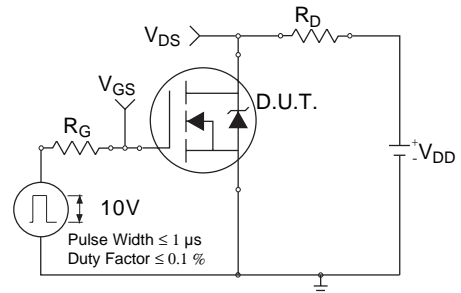

Fig 10a. Switching Time Test Circuit

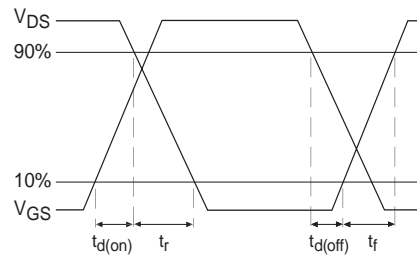

Fig 10b. Switching Time Waveforms

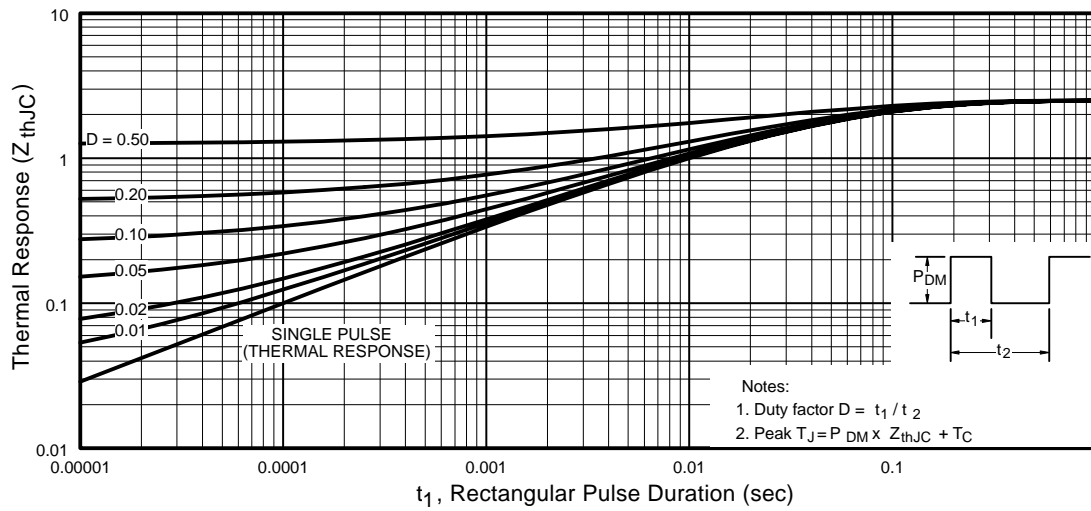

Fig 11. Maximum Effective Transient Thermal Impedance, Junction-to-Case

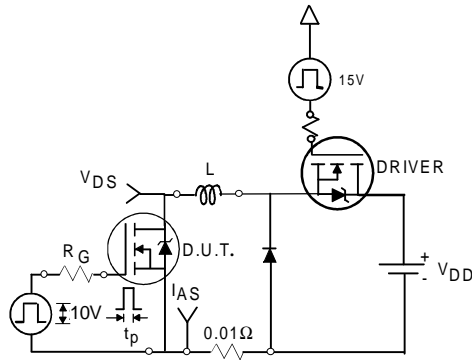

Fig 12a. Unclamped Inductive Test Circuit

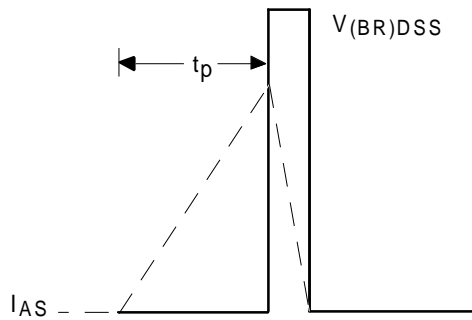

Fig 12b. Unclamped Inductive Waveforms

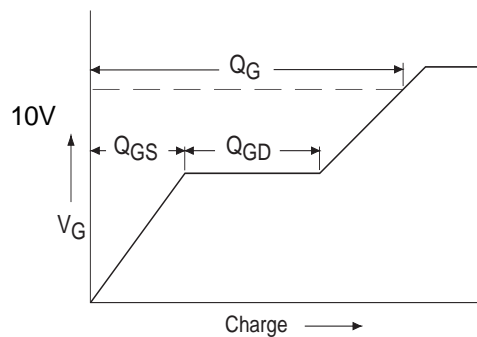

Fig 13a. Basic Gate Charge Waveform

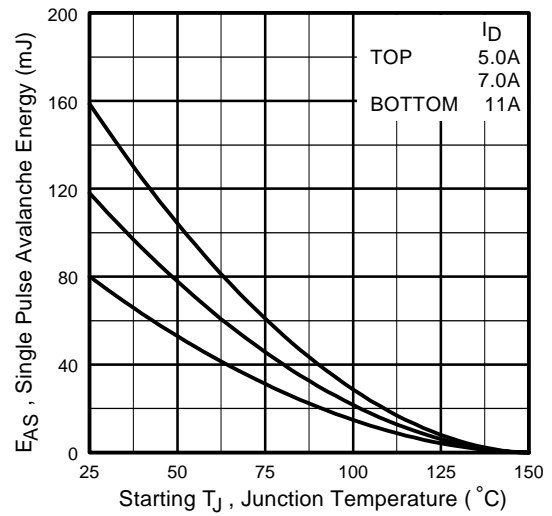

Fig 12c. Maximum Avalanche Energy Vs. Drain Current

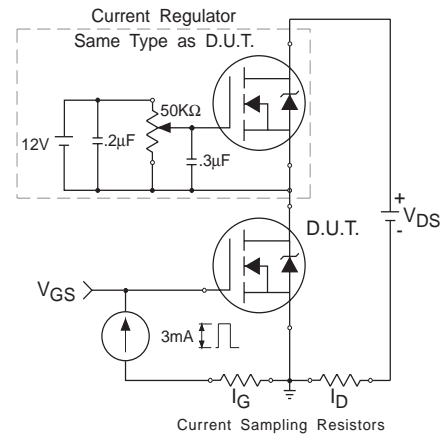

Fig 13b. Gate Charge Test Circuit

Footnotes:

- ① Repetitive Rating; Pulse width limited by maximum junction temperature.
- ② $V_{DD} = 25\text{ V}$, Starting $T_J = 25^\circ\text{C}$, $L=1.25\text{mH}$
Peak $I_{AS} = 11\text{A}$, $R_G = 25\Omega$
- ③ $I_{SD} \leq 11\text{A}$, $di/dt \leq 270\text{ A}/\mu\text{s}$,
 $V_{DD} \leq 200\text{V}$, $T_J \leq 150^\circ\text{C}$
- ④ Pulse width $\leq 400\ \mu\text{s}$; Duty Cycle $\leq 2\%$

Case Outline and Dimensions — LCC-28

