



Single-Channel Video Reconstruction Filters and Buffers

General Description

The MAX7462/MAX7463 single-channel, standard-definition, integrated video reconstruction filters and buffers are ideal for anti-aliasing and digital-to-analog smoothing video applications or wherever analog video is reconstructed from digital data (such as cable/satellite/terrestrial set-top boxes and DVRs).

The MAX7462 includes a disable function, which places the output in a high-impedance state allowing multiplexing of multiple output signals. It also has an external gain control that sets the output buffer gain to either +6dB or +9.5dB. The higher gain setting allows a lower DAC output signal than the standard 1V_{P-P} signal. The MAX7463 output buffer has a fixed gain of +6dB.

The MAX7462/MAX7463 operate from a single +5V supply and have a flat passband out to 5MHz with a stopband attenuation of -43dB (typ) at 27MHz.

These devices can drive two standard 150Ω AC-coupled or DC-coupled video loads. The output black level of the MAX7462/MAX7463 is less than 1V for DC-coupled outputs.

The MAX7462 is available in an 8-pin μMAX[®] package and an 8-pin SO package. The MAX7463 is available in an 8-pin SO package. All devices are specified over the 0°C to +85°C temperature range.

Applications

Cable/Satellite/Terrestrial Set-Top Boxes
DVRs
Hard-Disk Recorders

Features

- ◆ Standard-Definition CVBS Video Reconstruction Filters and Buffers
- ◆ Passband: -0.05dB at 5MHz
- ◆ Stopband: -43dB at 27MHz
- ◆ Selectable Gain: +6dB and +9.5dB (MAX7462)
- ◆ Output Disable (MAX7462)
- ◆ Drives 2V_{P-P} into Two 150Ω Video Loads
- ◆ Output Black Level < 1V for DC-Coupled Output
- ◆ Very Small μMAX and SO Packages

Ordering Information

PART	PIN-PACKAGE	BUFFER GAIN (dB)	OUTPUT DISABLE
MAX7462UUA*	8 μMAX	+6/+9.5 selectable	Yes
MAX7462USA	8 SO	+6/+9.5 selectable	Yes
MAX7463USA	8 SO	+6 fixed	No

Note: All parts are specified over the 0°C to +85°C temperature range.

*Future product—contact factory for availability.

Pin Configurations appear at end of data sheet.

Functional Diagram

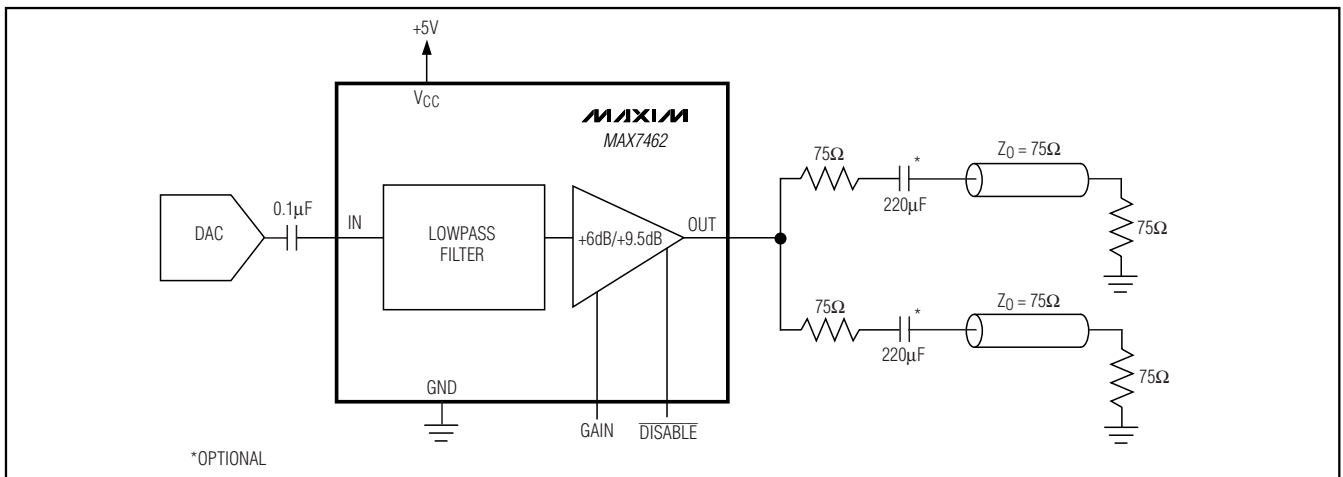

μMAX is a registered trademark of Maxim Integrated Products, Inc.



Maxim Integrated Products 1

For pricing, delivery, and ordering information, please contact Maxim/Dallas Direct! at 1-888-629-4642, or visit Maxim's website at www.maxim-ic.com.

Single-Channel Video Reconstruction Filters and Buffers

ABSOLUTE MAXIMUM RATINGS

V_{CC} to GND+6.0V
 All Other Pins to GND ...-0.3V to the lower of (V_{CC} + 0.3V) and +6V
 Maximum Current into Any Pin Except V_{CC} and GND±50mA
 Continuous Power Dissipation (T_A = +70°C)
 8-Pin μMAX (derate 4.5mW/°C above +70°C) 362mW
 8-Pin SO (derate 5.9mW/°C above +70°C) 470.6mW

Operating Temperature Range.....0°C to +85°C
 Storage Temperature Range-65°C to +150°C
 Lead Temperature (soldering, 10s)+300°C

Stresses beyond those listed under "Absolute Maximum Ratings" may cause permanent damage to the device. These are stress ratings only, and functional operation of the device at these or any other conditions beyond those indicated in the operational sections of the specifications is not implied. Exposure to absolute maximum rating conditions for extended periods may affect device reliability.

ELECTRICAL CHARACTERISTICS

(V_{CC} = +5V ±5%, C_L = 0 to 20pF, R_L = 75Ω, C_{IN} = 0.1μF, gain = +6dB, $\overline{\text{DISABLE}} = V_{CC}$ (MAX7462), T_A = T_{MIN} to T_{MAX}, unless otherwise noted. Typical values are at V_{CC} = +5V, and T_A = +25°C.)

PARAMETER	CONDITIONS	MIN	TYP	MAX	UNITS
Passband Response	f = 100kHz to 5MHz, relative to 100kHz	-0.65	-0.05	+0.65	dB
Stopband Attenuation	f ≥ 27MHz	39	43		dB
Output Dynamic Swing	Gain = GND (MAX7462)		2.0	2.4	V _{P-P}
Output Sync Tip Clamp Level	After termination (Note 1)	0.30	0.45	0.55	V
Group Delay Deviation	f = 100kHz to 4.2MHz		11		ns
Differential Gain	Five-step modulated staircase		0.15		%
Differential Phase	Five-step modulated staircase		0.15		Degrees
Signal-to-Noise Ratio	Output signal (2V _{P-P}) to RMS noise (100Hz to 5MHz)		75		dB
Low-Frequency Gain Accuracy	f = 100kHz, relative to a gain of +6dB	-3		+3	%
Line Time Distortion	18μs, 100 IRE bar		0.1		%
Field Time Distortion	130 lines, 18μs, 100 IRE bar		0.1		%
Power-Supply Rejection Ratio	V _{IN} = 100mV _{P-P} , f = 100kHz		35		dB
Supply Current	No load		25	35	mA

Note 1: Measured after 75Ω back-match resistor. Assume a 75Ω termination resistor.

Single-Channel Video Reconstruction Filters and Buffers

Typical Operating Characteristics

($V_{CC} = +5V \pm 5\%$, $C_L = 0$ to $20pF$, $R_L = 75\Omega$, $C_{IN} = 0.1\mu F$, gain = $+6dB$, $\overline{DISABLE} = V_{CC}$ (MAX7462), $T_A = T_{MIN}$ to T_{MAX} , unless otherwise noted. Typical values are at $V_{CC} = +5V$, and $T_A = +25^\circ C$.)

MAX7462/MAX7463

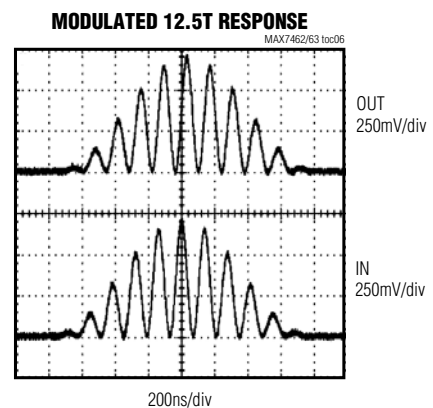
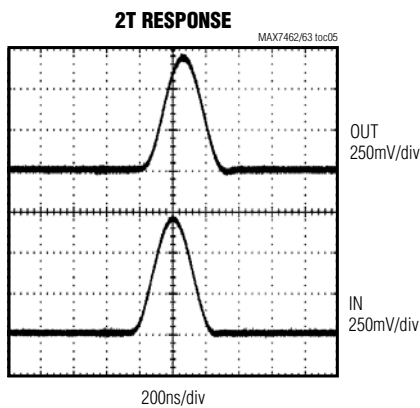
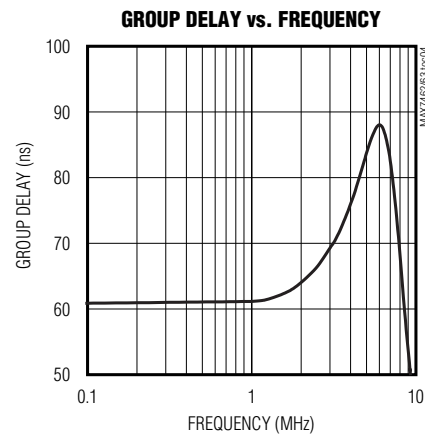
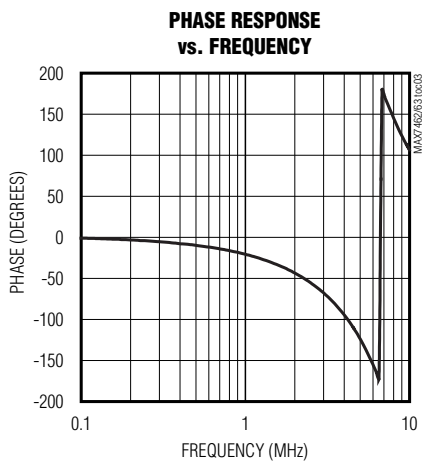
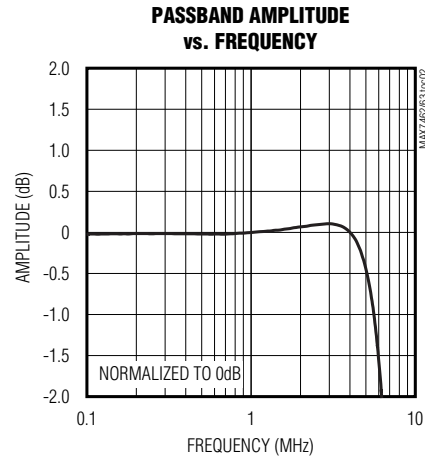
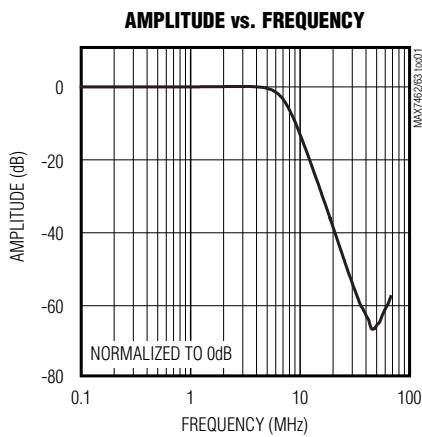

Single-Channel Video Reconstruction Filters and Buffers

Typical Operating Characteristics (continued)

($V_{CC} = +5V \pm 5\%$, $C_L = 0$ to $20pF$, $R_L = 75\Omega$, $C_{IN} = 0.1\mu F$, gain = $+6dB$, $\overline{DISABLE} = V_{CC}$ (MAX7462), $T_A = T_{MIN}$ to T_{MAX} , unless otherwise noted. Typical values are at $V_{CC} = +5V$, and $T_A = +25^\circ C$.)

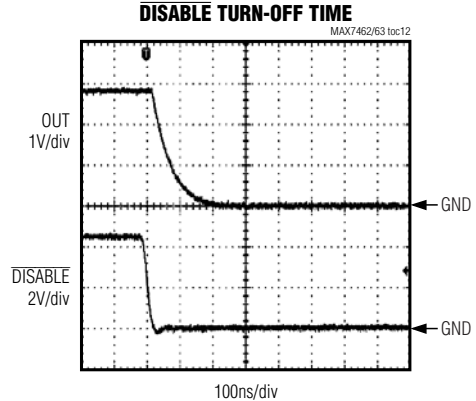
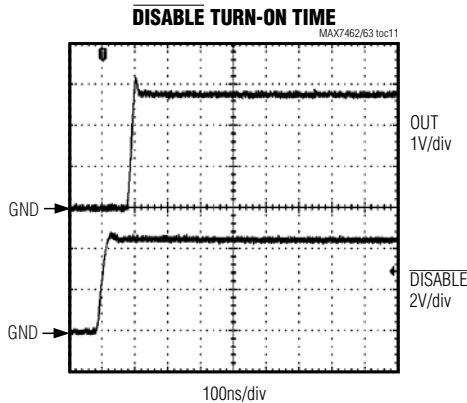
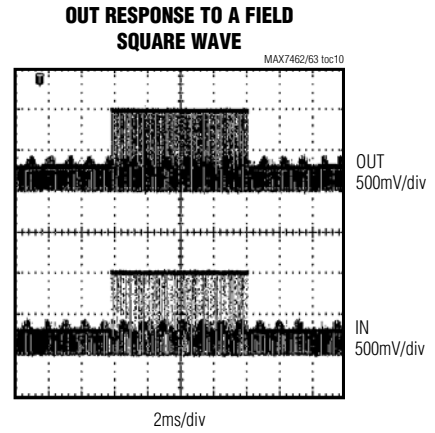
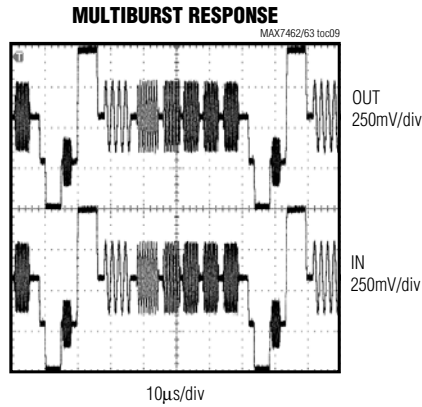
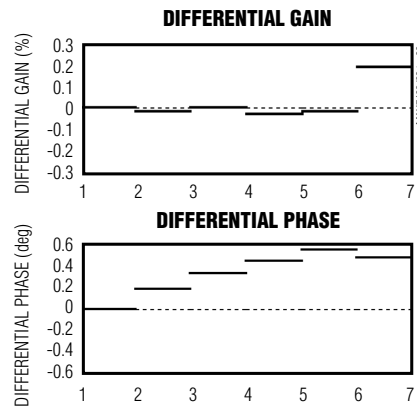
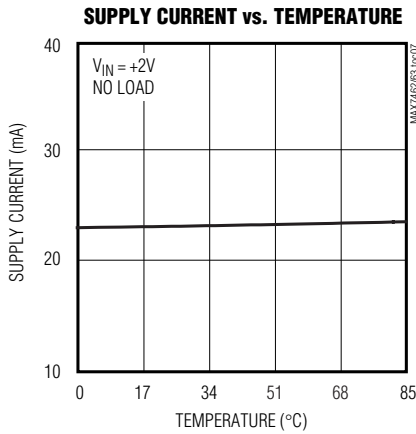

Single-Channel Video Reconstruction Filters and Buffers

Pin Description

PIN		NAME	FUNCTION
MAX7462	MAX7463		
1	1	IN	Video Input. AC-couple IN with a series 0.1 μ F capacitor.
2	—	GAIN	Gain Control Input. Connect GAIN to GND for a gain of +6dB (+2V/V). Connect GAIN to V _{CC} for a gain of +9.5dB (+3V/V).
3, 4, 5	3	GND	Ground
—	2, 4, 5, 6	N.C.	No Connection. Not internally connected. Connect to GND for better performance.
6	—	$\overline{\text{DISABLE}}$	Disable Input. Connect to V _{CC} to enable the output buffer (normal operation). Connect to GND to put the output buffer in a high-impedance state.
7	7	V _{CC}	+5V Supply Input
8	8	OUT	Buffer Output. This output can be either AC- or DC-coupled. Use at minimum a 220 μ F capacitor for AC-coupled loads.

Detailed Description

The MAX7462/MAX7463 filters and buffers the analog CVBS video outputs of DAC video-encoders in applications such as set-top boxes, hard-disk recorders, DVD players, and digital VCRs. The MAX7462/MAX7463 consist of a lowpass filter and an output video buffer that can drive two standard 150 Ω video loads. These devices operate from a single +5V supply and have a bandwidth optimized for interlaced NTSC, PAL, and SDTV.

Filter

The reconstruction filter is a 4th-order Butterworth-type response that features a maximally flat passband for NTSC and PAL bandwidths. The stopband attenuation is optimized for a video-encoder DAC sampling frequency of 27MHz (see the *Typical Operating Characteristics*).

Output Buffer

The output buffer can drive two 150 Ω video loads with a 2V_{P-P} signal. For the MAX7462, the output buffer gain is selectable between +6dB and +9.5dB by using GAIN (see Table 1). The MAX7463 has a fixed gain of +6dB.

The MAX7462/MAX7463 can drive an AC load or drive the video load directly without using a large output

Table 1. Gain Setting Control (MAX7462)

GAIN	BUFFER GAIN (dB)
GND	+6
V _{CC}	+9.5

capacitor. The output buffer can drive DC loads while maintaining an output blanking level of less than 1V. The blanking level allows the MAX7462/MAX7463 to meet the digital TV interface specifications for DC coupling.

Applications Information

Input Considerations

Use a 0.1 μ F ceramic capacitor to AC-couple the input. The input capacitor stores a DC voltage so that the output is clamped to the appropriate DC voltage level.

Output Considerations

The outputs are typically connected to a 75 Ω series back-match resistor followed by the video cable. Because of the inherent divide-by-two of this configuration, the blanking level on the video cable is always less than 1V, complying with industry-standard video requirements such as the digital TV standard (which allows up to 1VDC on the video cable) and the European SCART standard (which allows up to 2VDC on the video cable). The video buffer can also drive an AC-coupled video load. Good video performance is achieved with an output capacitor as low as 220 μ F.

Power-Supply Bypassing and Layout

The MAX7462/MAX7463 operate from a single +5V supply. Bypass V_{CC} to GND with a 0.1 μ F capacitor. In addition, it is sometimes advantageous to connect a 10 μ F capacitor within the general vicinity of the video circuitry. Place all other external components as close to the device as possible.

Single-Channel Video Reconstruction Filters and Buffers

Pin Configurations

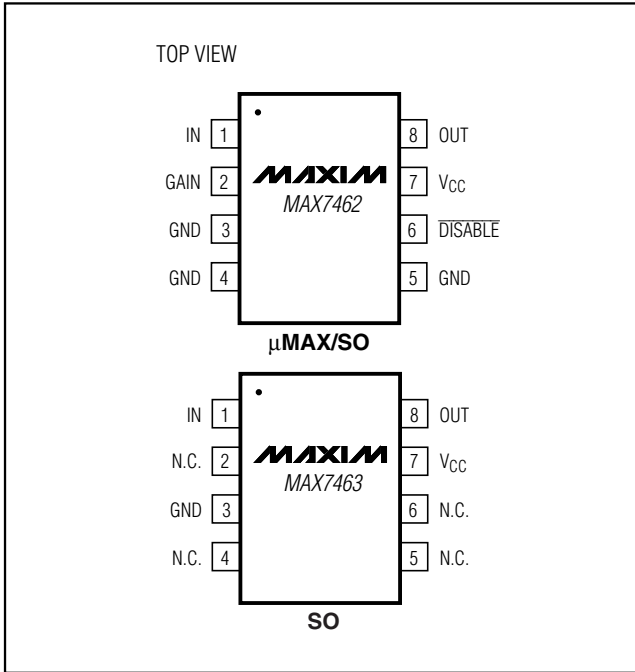

Chip Information

PROCESS: BiCMOS

Single-Channel Video Reconstruction Filters and Buffers

Package Information

(The package drawing(s) in this data sheet may not reflect the most current specifications. For the latest package outline information, go to www.maxim-ic.com/packages.)

MAX7462/MAX7463

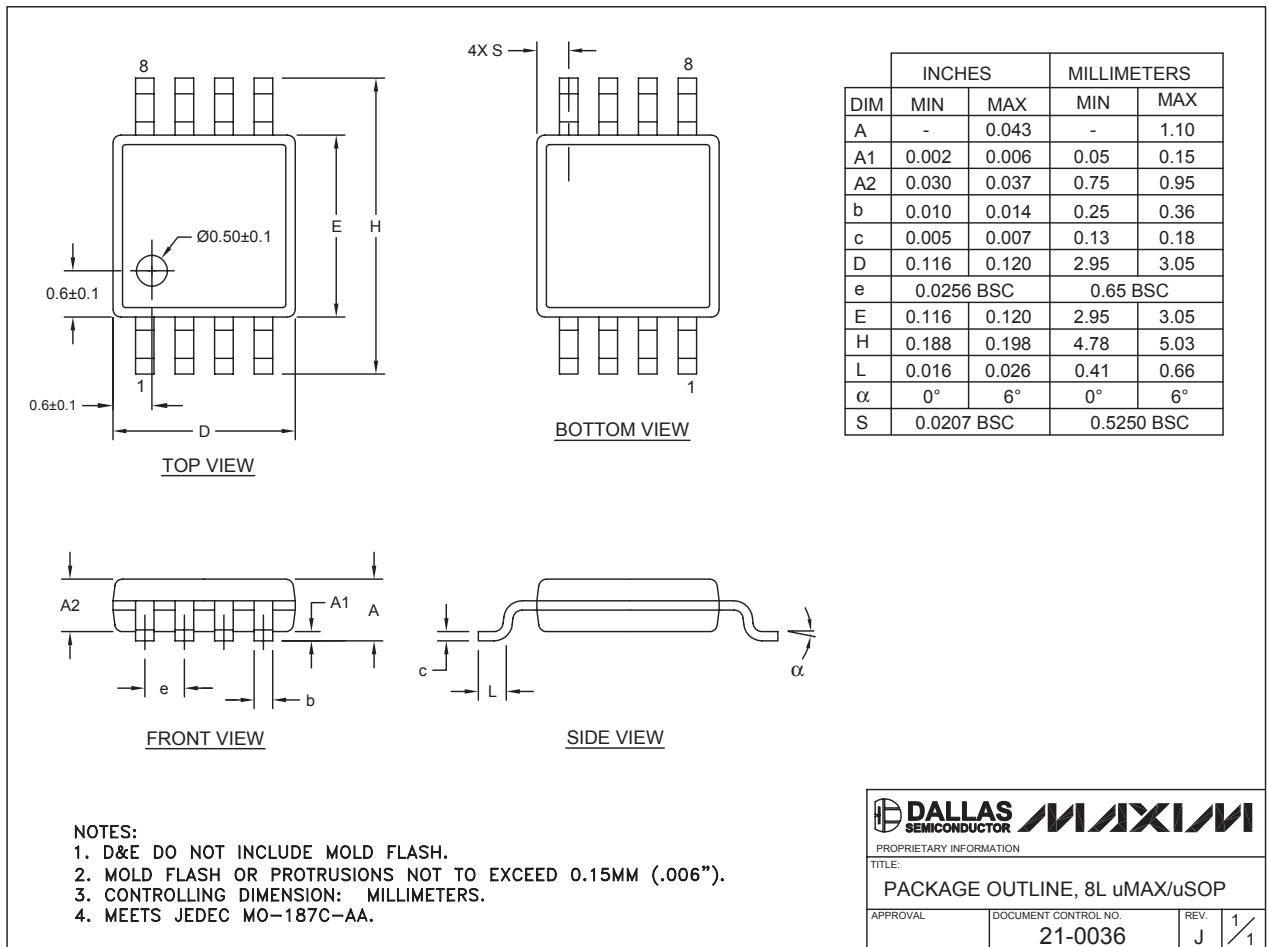

8LUMAXDEPS

DALLAS SEMICONDUCTOR **MAXIM**
 PROPRIETARY INFORMATION
 TITLE: PACKAGE OUTLINE, 8L uMAX/uSOP
 APPROVAL: _____ DOCUMENT CONTROL NO. 21-0036 REV. J 1/1

Single-Channel Video Reconstruction Filters and Buffers

Package Information (continued)

(The package drawing(s) in this data sheet may not reflect the most current specifications. For the latest package outline information, go to www.maxim-ic.com/packages.)

SOICN, EPS

DIM	INCHES		MILLIMETERS	
	MIN	MAX	MIN	MAX
A	0.053	0.069	1.35	1.75
A1	0.004	0.010	0.10	0.25
B	0.014	0.019	0.35	0.49
C	0.007	0.010	0.19	0.25
e	0.050 BSC		1.27 BSC	
E	0.150	0.157	3.80	4.00
H	0.228	0.244	5.80	6.20
L	0.016	0.050	0.40	1.27

VARIATIONS:

DIM	INCHES		MILLIMETERS		N	MS012
	MIN	MAX	MIN	MAX		
D	0.189	0.197	4.80	5.00	8	AA
D	0.337	0.344	8.55	8.75	14	AB
D	0.386	0.394	9.80	10.00	16	AC

NOTES:

1. D&E DO NOT INCLUDE MOLD FLASH.
2. MOLD FLASH OR PROTRUSIONS NOT TO EXCEED 0.15mm (.006").
3. LEADS TO BE COPLANAR WITHIN 0.10mm (.004").
4. CONTROLLING DIMENSION: MILLIMETERS.
5. MEETS JEDEC MS012.
6. N = NUMBER OF PINS.

DALLAS SEMICONDUCTOR		MAXIM	
PROPRIETARY INFORMATION			
TITLE: PACKAGE OUTLINE, .150" SOIC			
APPROVAL	DOCUMENT CONTROL NO.	REV.	1/1
	21-0041	B	

Maxim cannot assume responsibility for use of any circuitry other than circuitry entirely embodied in a Maxim product. No circuit patent licenses are implied. Maxim reserves the right to change the circuitry and specifications without notice at any time.

8 **Maxim Integrated Products, 120 San Gabriel Drive, Sunnyvale, CA 94086 408-737-7600**