



DATE : 28.Nov.2007

SAMSUNG TFT-LCD

MODEL : LTI520HB01-001

The Information Described in this Specification is Preliminary and can be changed without prior notice

APPROVED BY Nam-Heon Kim	DATE 28.Nov.2007	PREPARED BY Yu-Geun Lee	DATE 28.Nov.2007
------------------------------------	---------------------	-----------------------------------	---------------------

Development Group 3, LCD Business

Samsung Electronics Co . , LTD.

MODEL	LTI520HB01 - 001	Doc. No	05 - 001 - G - 071128	Page	1 / 27
-------	------------------	---------	-----------------------	------	--------

Contents

Revision History	(3)
General Description	(4)
General Information	(4)
1. Absolute Maximum Ratings	(5)
2. Application information for I.D. (Information Display)	(6)
3. Optical Characteristics	(7)
4. Electrical Characteristics	(10)
4.1 TFT LCD Module	
4.2 Back Light Unit	
4.3 Inverter Input & Specification	
5. Input Terminal Pin Assignment	(13)
5.1 Input Signal & Power	
5.2 Inverter Input Pin Configuration	
5.3 Inverter Input Power Sequence	
5.4 LVDS Interface	
5.5 Input Signals, Basic Display Colors and Gray Scale of Each Color	
6. Interface Timing	(18)
6.1 Timing Parameters (DE only mode)	
6.2 Timing Diagrams of interface Signal (DE only mode)	
6.3 Power ON/OFF Sequence	
7. Outline Dimension	(21)
8. Packing	(23)
9. Marking & Others	(24)
10. General Precaution	(25)
10.1 Handling	
10.2 Storage	
10.3 Operation	
10.4 Operation Condition Guide	
10.5 Others	

MODEL

LTI520HB01 - 001

Doc. No

05-001-G-071128

Page

2 / 27

* Revision History

Date	Rev. No	Page	Summary
Nov 15, 2007	000	all	First issued
Nov 28, 2007	001	7	Response time
			Rising Typ : 8ms → 14ms Rising Max : 10ms → 24ms Falling Typ : 14ms → 8ms Falling Max : 24ms → 10ms

MODEL

LTI520HB01 - 001

Doc. No

05-001 - G - 071128

Page

3 / 27

General Description

Description

LTI520HB01-001 is a color active matrix liquid crystal display (LCD) that uses amorphous silicon TFT (Thin Film Transistor) as switching components. This model is composed of a TFT LCD panel, a driver circuit and a back light unit. The resolution of a 52.0" is 1920 x 1080 and this model can display up to 16.7 million colors with wide viewing angle of 89° or higher in all directions. This panel is intended to support applications to provide an excellent performance for Flat Panel Display such as Home-alone Multimedia TFT-LCD TV, Display terminals for AV application products, and Digital Information Display (DID).

Features

- RoHS compliance (Pb-free)
- High contrast ratio, High aperture ratio, High luminance
- SPVA (Super Patterned Vertical Align) mode
- Wide viewing angle ($\pm 178^\circ$)
- High speed response
- Landscape / Portrait type compatible
- WXGA (1920 x 1080 pixels) resolution (16:9)
- Low Power consumption
- Direct Type 28 CCFTs (Cold Cathode Fluorescent Tube)
- DE (Data Enable) mode
- LVDS (Low Voltage Differential Signaling) interface (2pixel/clock)

General Information

Items	Specification	Unit	Note
Module Size	1192.0(W _{TYP}) x 688.0(H _{TYP})	mm	± 1.0 mm
	62.0(D _{MAX})		
Weight	23,000(Max.)	g	
Pixel Pitch	0.6(H) x 0.6(V)	mm	
Active Display Area	1152.0(H) x 648.0(V)	mm	
Surface Treatment	Haze 44% , Hard-coating (3H)		
Display Colors	8 bit - 16.7M	colors	
Number of Pixels	1920 x 1080	pixel	
Pixel Arrangement	RGB vertical stripe		
Display Mode	Normally Black		
Luminance of White	600 (Typ.)	cd/m ²	

MODEL

LTI520HB01-001

Doc. No

05-001-G-071128

Page

4 / 27

1. Absolute Maximum Ratings

If the condition exceeds maximum ratings, it can cause malfunction or unrecoverable damage to the device.

Item	Symbol	Min.	Max.	Unit	Note
Power Supply Voltage	V_{DD}	GND-0.5	13.2	V	(1)
Storage temperature	T_{STG}	-20	60		(2)
Glass surface temperature (Operation)	Center	T_{OPR}	0	50	(2),(5)
	T. Uniformity	T	-	10	
Shock (non - operating)	S_{nop}	-	30	G	(3)
Vibration (non - operating)	V_{nop}	-	1.5	G	(4)

Note (1) $T_a = 25 \pm 2 \text{ }^\circ\text{C}$

(2) Temperature and relative humidity range are shown in the figure below.

a. 90 % RH Max. ($T_a < 39 \text{ }^\circ\text{C}$)

b. Relative Humidity is 90% or less. ($T_a > 39 \text{ }^\circ\text{C}$)

c. No condensation

(3) 11ms, sine wave, one time for $\pm X$, $\pm Y$, $\pm Z$ axis

(4) 10-300 Hz, Sweep rate 10min, 30min for X,Y,Z axis

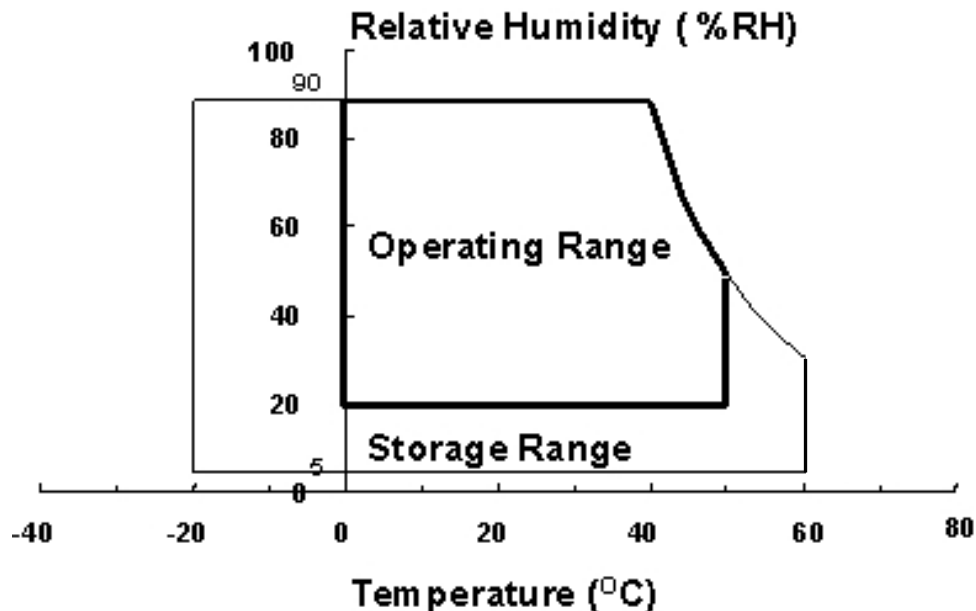
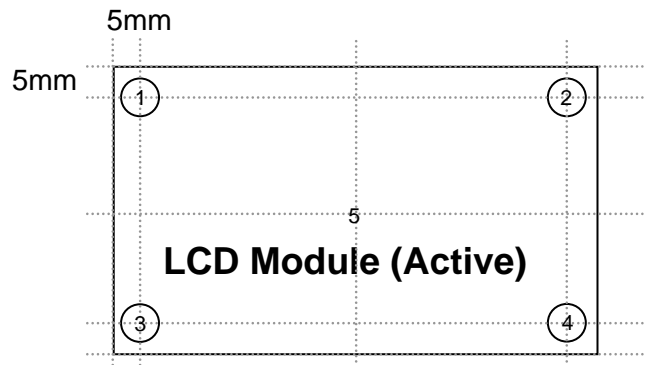

Fig. Temperature and Relative humidity range

(5) Definition of test point



T_{OPR} : Temperature of the center of the glass surface (Test point 5)
 $T1 \sim T4$: Temperature of each edge of the glass surface
 T_{MAX} : The highest temperature of the glass surface

2. Application information for I.D. (Information Display)

Generally large-sized LCD modules are designed for TV applications. A long-term display like DID application can cause uneven display including image retention. To optimize module's lifetime and function, several operating usages are required.

1. Normal operating condition

- Temperature: 20 ± 15
- Humidity: $65 \pm 20 \%$
- Display pattern: moving picture or regular switchover display

Note) Long-term static information image may cause uneven display.

2. Operating usages under abnormal operating condition. Note (1)

- Ambient condition
 - Well-ventilated place is recommended to set up I.D. system.
- Power off and screen saver
 - Periodical power-off or screen saver is needed after long-term static display. Note (2)

3. Operating usages to protect uneven display due to long-term static information display

- Suitable operating time: under 18 hours a day.
- Static information display is recommended to use moving picture periodically.
 - Change display to moving picture for 10 seconds after 5 minutes static information display.
- Background and character (image) color change
 - Use different colors for background and character (image), respectively.
 - Change colors periodically.
- Avoid combination of background and character with large different luminance.

Note (1) Abnormal condition means every operating condition except normal operating condition.

Note (2) Moving picture or black pattern is strongly recommended for screen saver.

4. Lifetime in this spec is guaranteed only when I.D. is used under operating usages.

MODEL	LTI520HB01-001	Doc. No	05-001-G-071128	Page	6 / 27
-------	----------------	---------	-----------------	------	--------

3. Optical Characteristics

The optical characteristics should be measured in a dark room or equivalent.

Measuring equipment : TOPCON BM-7,SPECTRORADIOMETER SR-3

(Ta = 25 ± 2°C, VDD = 12V, fv = 60Hz, f_{DCLK} = 148.5MHz, I_L = 6.0mArms)

Item	Symbol	Condition	Min.	Typ.	Max.	Unit	Note	
Contrast Ratio (Center of screen)	C/R	Normal $\theta_{L,R}=0$ $\theta_{U,D}=0$ Viewing Angle	1300	1700	-		(3) SR-3	
Response Time	Rising		Tr	-	14	24	Msec	(5) BM-7
	Falling		Tf	-	8	10		
	G-to-G		Tg	-	8	-		
Luminance of White (Center of screen)	Y _L			500	600	-	cd/m ²	(6) SR-3
Color Chromaticity (CIE 1931)	Red		Rx	TYP. -0.03	0.645	TYP. +0.03		(7),(8) SR-3
			Ry		0.336			
	Green		Gx		0.275			
			Gy		0.606			
	Blue		Bx		0.143			
		By	0.067					
	White	Wx	0.280					
		Wy	0.290					
Color Gamut	-		-	72	-	%	(7) SR-3	
Color Temperature	-		-	10,000	-	K	(7) SR-3	
Viewing Angle	Hor.	θ_L	C/R 10	75	89	-	Degree	(8) SR-3
		θ_R		75	89	-		
	Ver.	θ_U		75	89	-		
		θ_D		75	89	-		
Brightness Uniformity (9 Points)	B _{uni}		-	-	25	%	(4) SR-3	

Note (1) Test Equipment Setup

The measurement should be executed in a stable, windless and dark room between 40min and 60min after lighting the back light at the given temperature for stabilization of the back light. This should be measured in the center of screen.

Single lamp current : 6.0mA

Environment condition : Ta = 25 ± 2 °C

MODEL

LTI520HB01-001

Doc. No

05-001-G-071128

Page

7 / 27

Photo detector	Field
SR-3	1 °
BM-7	2 °

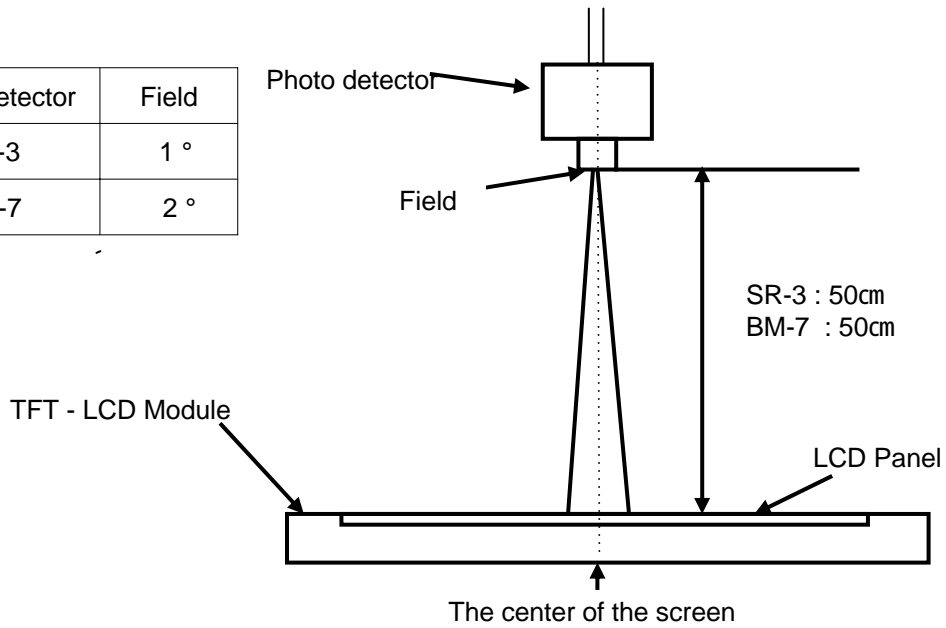

Note (2) Definition of test point

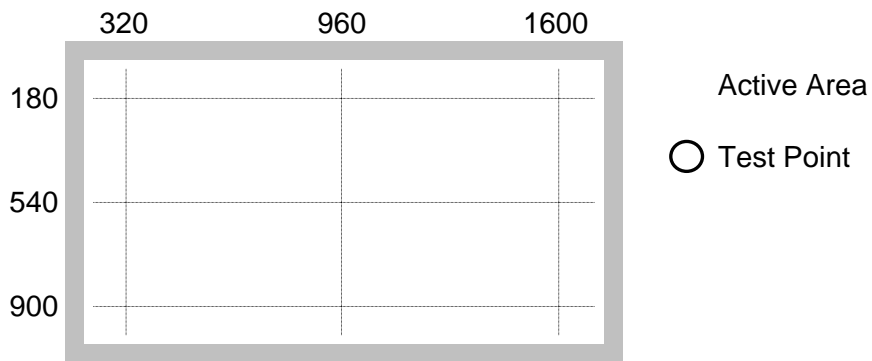

Note (3) Definition of Contrast Ratio (C/R)

: Ratio of gray max (Gmax) & gray min (Gmin) at the center point of the panel

$$C/R = \frac{G_{\max}}{G_{\min}}$$

Gmax : Luminance with all pixels white

Gmin : Luminance with all pixels black

MODEL

LTI520HB01-001

Doc. No

05-001-G-071128

Page

8 / 27

Note (4) Definition of 9 points brightness uniformity

$$B_{uni} = 100 * \frac{(B_{max} - B_{min})}{B_{max}}$$

Bmax : Maximum brightness

Bmin : Minimum brightness

Note (5) Definition of Response time : Sum of Tr, Tf

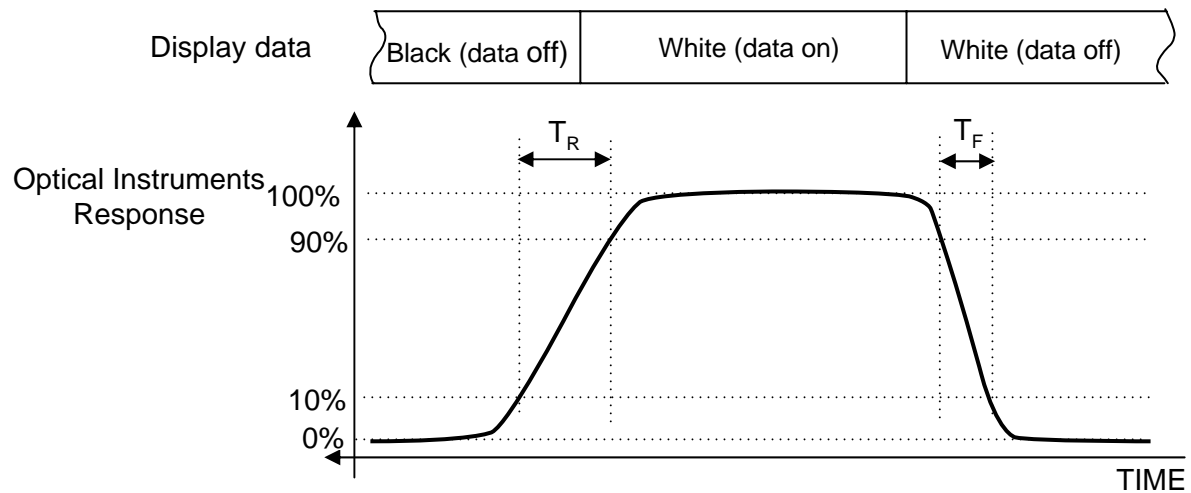

Note (6) Definition of Luminance of White : Luminance of white at center point

Note (7) Definition of Color Chromaticity (CIE 1931)

Color coordinate of Red, Green, Blue & White at center point

Note (8) Definition of Viewing Angle

: Viewing angle range (C/R 10)

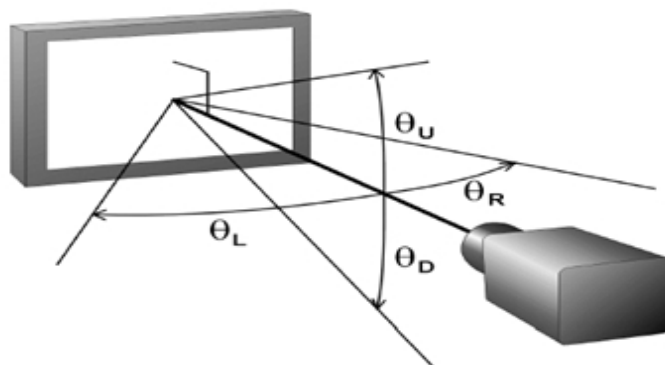

4. Electrical Characteristics

4.1 TFT LCD Module

The connector for display data & timing signal should be connected.

$T_a = 25^\circ\text{C} \pm 2^\circ\text{C}$

Item	Symbol	Min.	Typ.	Max.	Unit	Note
Voltage of Power Supply	V_{DD}	10.8	12.0	13.2	V	(1)
Current of Power Supply	(a) Black	-	870	-	mA	(2),(3)
	(b) White	-	1250	-	mA	
	(c) N-Pattern	-	1540	1660	mA	
Vsync Frequency	f_V	48	60	62	Hz	
Hsync Frequency	f_H	50.0	67.5	75.0	kHz	
Main Frequency	f_{DCLK}	130.0	148.5	155.0	MHz	
Rush Current	I_{RUSH}	-	-	5	A	(4)

Note (1) The ripple voltage should be controlled under 10% of V_{DD} .

(2) $f_V = 60\text{Hz}$, $f_{DCLK} = 148.5\text{MHz}$, $V_{DD} = 12.0\text{V}$, DC Current.

(3) Power dissipation check pattern (LCD Module only)

a) Black Pattern



b) White Pattern



c) N-Pattern

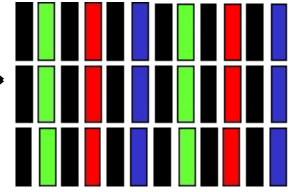
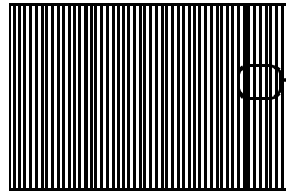

(4) Measurement Conditions

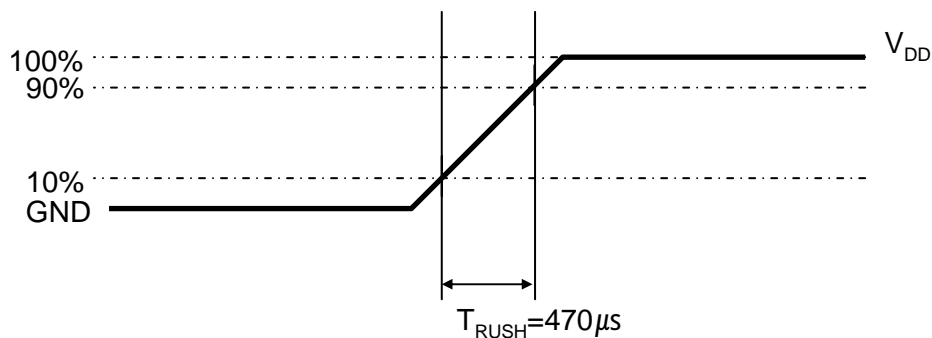

Rush Current I_{RUSH} can be measured when T_{RUSH} is $470\mu\text{s}$.

4.2 Back Light Unit

The back light unit contains 28 direct-lighting type CCFTs (Cold Cathode Fluorescent Tube). The characteristics of lamps are shown in the following tables.

$T_a = 25 \pm 2^\circ\text{C}$

Item	Symbol	Min.	Typ.	Max.	Unit	Note
Lamp Current	I_L	3.0	6.0	7.0	mArms	
Lamp Voltage	V_L	2040	1850	1790	Vrms	
Operating Life Time	Hr	50000	-	-	Hour	(1)

Note (1) It is defined as the time to take until the brightness reduces to 50% of its original value.

[Operating condition : $T_a = 25 \pm 2$, $I_L = 6.0\text{mArms}$, For single lamp only]

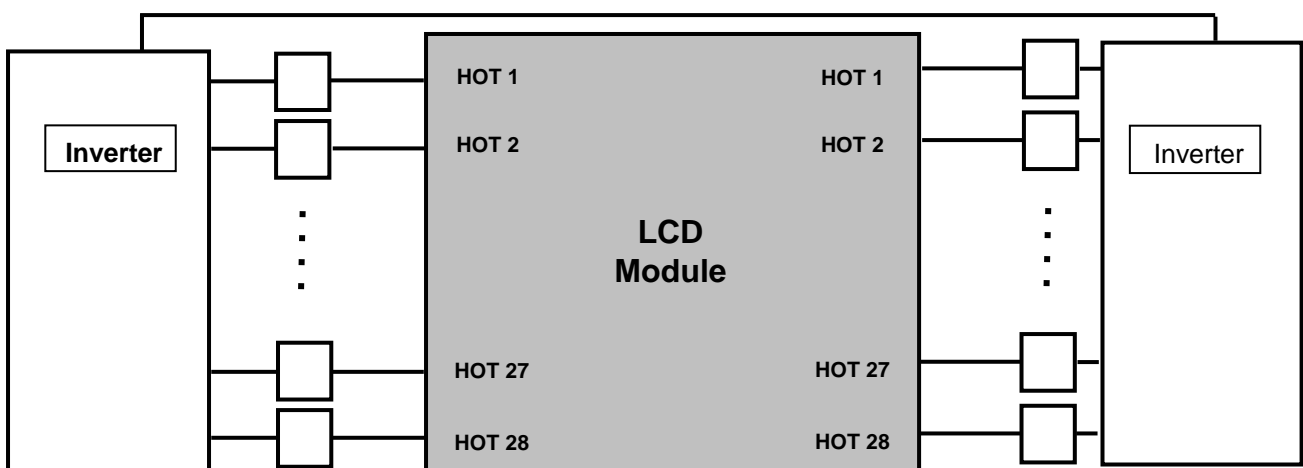

4.3 Inverter Input Condition & Specification

Items	Symbol	Conditions	Specifications			Unit	Note
			Min.	Typ.	Max.		
Input Voltage	V _{in}	-	22	24	26	V	Ta=25±2 °C
Input Current	I _{in}	V _{in} = 24.0V V _{dim} = 3.3V	-	-	15	A	After 1 hour Warm-up @ Vin=24V
Lamp Current	I _{O,MAX}	V _{dim} = 3.3V	5.5	6.0	6.5	mArms	
Frequency	F _{LAMP}	V _{in} = 24.0V V _{dim} = 3.3V	42	44	46	kHz	
Backlight On/Off	On	V _{in} = 24.0V	2.4	-	5.5	V	-
	Off		0	-	0.8		
Dimming Control	V _{DIM}	Max Lum	3.3	-	-	V	-
		Min. Lum	-	-	0		

Note (1) Power Consumption is measured at 600[cd/m²] of luminance condition which is the typical luminance value. Lamp Current is measured at the point before Lamp.

MODEL

LTI520HB01-001

Doc. No

05-001-G-071128

Page

12 / 27

5. Input Terminal Pin Assignment

5.1 Input Signal & Power

Connector : FI-RE51S-HF (JAE)

PIN No.	Description		PIN No.	Description	
1	Vdd (12V)		26	Even LVDS Signal	
2	Vdd (12V)		27		RE[0]P
3	Vdd (12V)		28		RE[1]N
4	Vdd (12V)		29		RE[1]P
5	Vdd (12V)		30		RE[2]N
6	GND		31		RE[2]P
7	GND		32		GND
8	GND		33		RECLK-
9	GND		34		RECLK+
10	Odd LVDS Signal	RO[0]N	35		GND
11		RO[0]P	36	RE[3]N	
12		RO[1]N	37	RE[3]P	
13		RO[1]P	38	No Connection	
14		RO[2]N	39	No Connection	
15		RO[2]P	40	GND	
16		GND	41	No Connection	
17		ROCLK-	42	No Connection	
18		ROCLK+	43	No Connection	
19		GND	44	No Connection	
20		RO[3]N	45	LVDS Option	
21		RO[3]P	46	No Connection	
22	No Connection		47	No Connection	
23	No Connection		48	No Connection	
24	GND		49	No Connection	
25	Even LVDS	RE[0]N	50	No Connection	
			51	No Connection	

Note(1) No Connection :These pins are only used for SAMSUNG internal purpose.

(2) LVDS Option : High (3.3 V) Normal LVDS format
: Low (GND) or Open (N.C) JEIDA LVDS format
Sequence :On = VDD(T1) LVDS Option Interface Signal(T2)
Off = Interface Signal(T3) LVDS Option VDD

Note (2) LVDS Connector

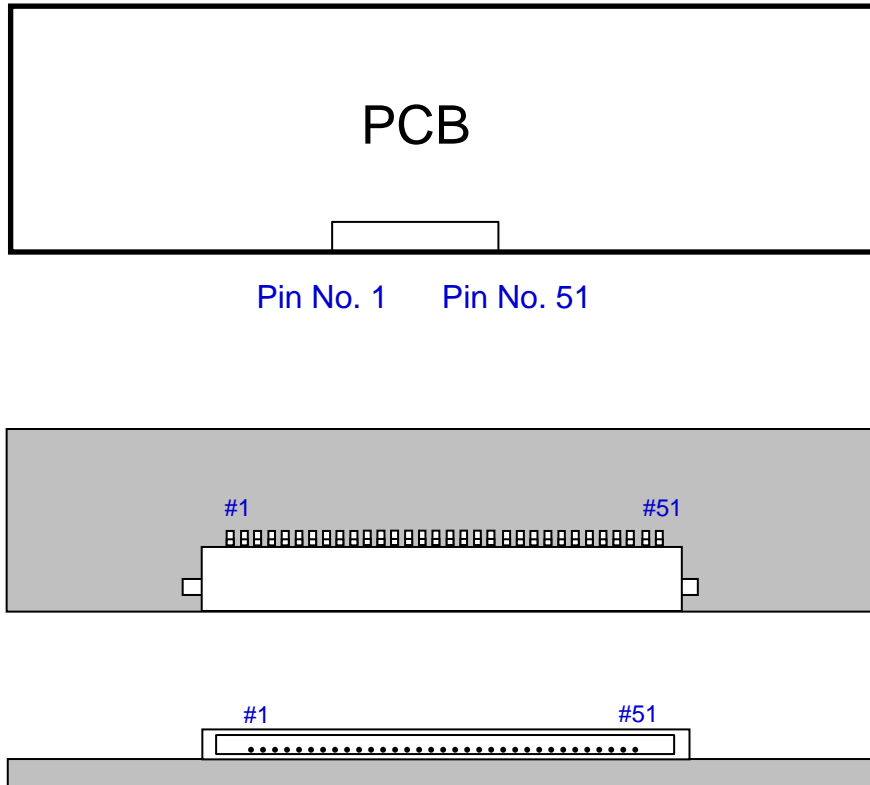

Fig. Connector diagram

- a. All GND pins should be connected together and also be connected to the LCD's metal chassis.
- b. All power input pins should be connected together.
- c. All N.C pins should be separated from other signal or power.

MODEL	LTI520HB01 - 001	Doc. No	05-001 - G - 071128	Page	14 / 27
-------	------------------	---------	---------------------	------	---------

5.2 Inverter Input Pin Configuration

Connector : JST, S14B-PHA-SM-TB(LF)

Pin No.	Pin Configuration(FUNCTION)
1	Vin (24V)
2	Vin (24V)
3	Vin (24V)
4	Vin (24V)
5	Vin (24V)
6	GND
7	GND
8	GND
9	GND
10	GND
11	No Connection
12	Backlight On /Off [On: 2.4 ~ 5.5 V, Off: 0 ~ 0.8 V]
13	Dimming Control [0V: Min, 3.3V: Max]
14	No Connection

5.3 Inverter Input Power Sequence

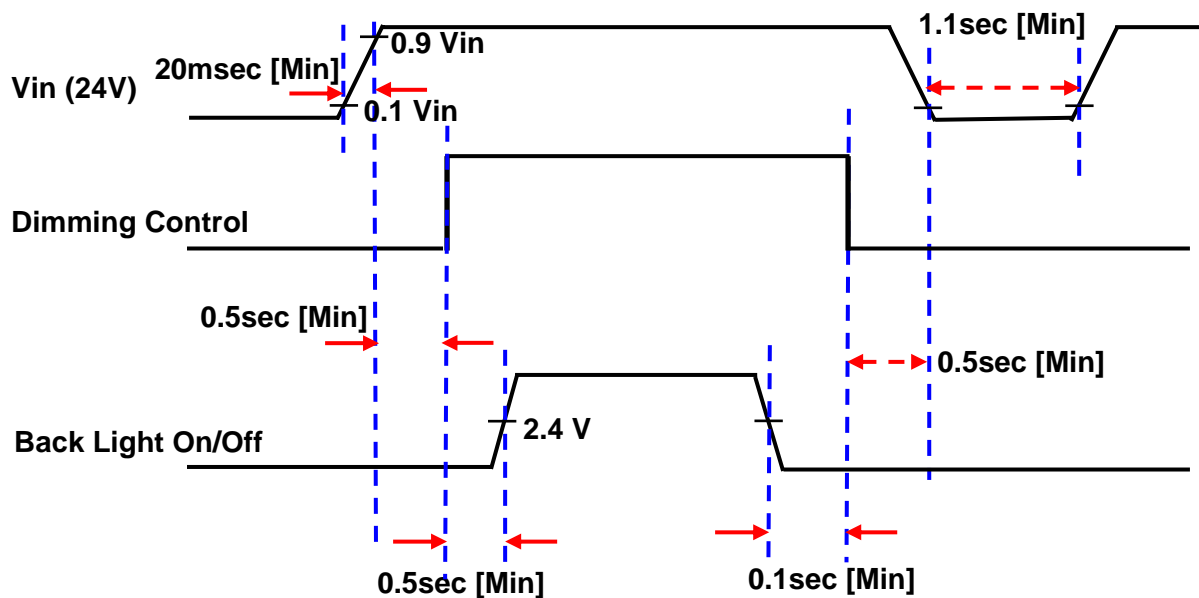

MODEL

LTI520HB01-001

Doc. No

05-001-G-071128

Page

15 / 27

5.4 LVDS Interface

- LVDS Receiver : Tcon (merged)
- Data Format (JEIDA & Normal)

Default LVDS Option : JEIDA

	LVDS pin	JEIDA -DATA	VESA -DATA
TxOUT/RxIN0	TxIN/RxOUT0	R2	R0
	TxIN/RxOUT1	R3	R1
	TxIN/RxOUT2	R4	R2
	TxIN/RxOUT3	R5	R3
	TxIN/RxOUT4	R6	R4
	TxIN/RxOUT6	R7	R5
	TxIN/RxOUT7	G2	G0
TxOUT/RxIN1	TxIN/RxOUT8	G3	G1
	TxIN/RxOUT9	G4	G2
	TxIN/RxOUT12	G5	G3
	TxIN/RxOUT13	G6	G4
	TxIN/RxOUT14	G7	G5
	TxIN/RxOUT15	B2	B0
	TxIN/RxOUT18	B3	B1
TxOUT/RxIN2	TxIN/RxOUT19	B4	B2
	TxIN/RxOUT20	B5	B3
	TxIN/RxOUT21	B6	B4
	TxIN/RxOUT22	B7	B5
	TxIN/RxOUT24	HSYNC	HSYNC
	TxIN/RxOUT25	VSYNC	VSYNC
	TxIN/RxOUT26	DEN	DEN
TxOUT/RxIN3	TxIN/RxOUT27	R0	R6
	TxIN/RxOUT5	R1	R7
	TxIN/RxOUT10	G0	G6
	TxIN/RxOUT11	G1	G7
	TxIN/RxOUT16	B0	B6
	TxIN/RxOUT17	B1	B7
	TxIN/RxOUT23	RESERVED	RESERVED

MODEL

LTI520HB01-001

Doc. No

05-001-G-071128

Page

16 / 27

5.5 Input Signals, Basic Display Colors and Gray Scale of Each Color

COLOR	DISPLAY (8bit)	DATA SIGNAL																								GRAY SCALE LEVEL
		RED								GREEN								BLUE								
		R0	R1	R2	R3	R4	R5	R6	R7	G0	G1	G2	G3	G4	G5	G6	G7	B0	B1	B2	B3	B4	B5	B6	B7	
BASIC COLOR	BLACK	0	0	0	0	0	0	0	0	0	0	0	0	0	0	0	0	0	0	0	0	0	0	0	0	-
	BLUE	0	0	0	0	0	0	0	0	0	0	0	0	0	0	0	0	1	1	1	1	1	1	1	1	-
	GREEN	0	0	0	0	0	0	0	0	1	1	1	1	1	1	1	1	0	0	0	0	0	0	0	0	-
	CYAN	0	0	0	0	0	0	0	0	1	1	1	1	1	1	1	1	1	1	1	1	1	1	1	1	-
	RED	1	1	1	1	1	1	1	1	0	0	0	0	0	0	0	0	0	0	0	0	0	0	0	0	-
	MAGENTA	1	1	1	1	1	1	1	1	0	0	0	0	0	0	0	0	1	1	1	1	1	1	1	1	-
	YELLOW	1	1	1	1	1	1	1	1	1	1	1	1	1	1	1	1	0	0	0	0	0	0	0	0	-
	WHITE	1	1	1	1	1	1	1	1	1	1	1	1	1	1	1	1	1	1	1	1	1	1	1	1	-
GRAY SCALE OF RED	BLACK	0	0	0	0	0	0	0	0	0	0	0	0	0	0	0	0	0	0	0	0	0	0	0	R0	
	DARK	1	0	0	0	0	0	0	0	0	0	0	0	0	0	0	0	0	0	0	0	0	0	0	R1	
		0	1	0	0	0	0	0	0	0	0	0	0	0	0	0	0	0	0	0	0	0	0	0	R2	
		:	:	:	:	:	:	:	:	:	:	:	:	:	:	:	:	:	:	:	:	:	:	:	R3~R252	
		:	:	:	:	:	:	:	:	:	:	:	:	:	:	:	:	:	:	:	:	:	:	:		
	LIGHT	1	0	1	1	1	1	1	1	0	0	0	0	0	0	0	0	0	0	0	0	0	0	0	R253	
		0	1	1	1	1	1	1	1	0	0	0	0	0	0	0	0	0	0	0	0	0	0	0	R254	
	RED	1	1	1	1	1	1	1	1	0	0	0	0	0	0	0	0	0	0	0	0	0	0	0	R255	
GRAY SCALE OF GREEN	BLACK	0	0	0	0	0	0	0	0	0	0	0	0	0	0	0	0	0	0	0	0	0	0	0	G0	
	DARK	0	0	0	0	0	0	0	0	1	0	0	0	0	0	0	0	0	0	0	0	0	0	0	G1	
		0	0	0	0	0	0	0	0	0	1	0	0	0	0	0	0	0	0	0	0	0	0	0	G2	
		:	:	:	:	:	:	:	:	:	:	:	:	:	:	:	:	:	:	:	:	:	:	:	G3~G252	
		:	:	:	:	:	:	:	:	:	:	:	:	:	:	:	:	:	:	:	:	:	:	:		
	LIGHT	0	0	0	0	0	0	0	0	1	0	1	1	1	1	1	1	0	0	0	0	0	0	0	G253	
		0	0	0	0	0	0	0	0	0	1	1	1	1	1	1	1	0	0	0	0	0	0	0	G254	
	GREEN	0	0	0	0	0	0	0	0	1	1	1	1	1	1	1	1	0	0	0	0	0	0	0	G255	
GRAY SCALE OF BLUE	BLACK	0	0	0	0	0	0	0	0	0	0	0	0	0	0	0	0	0	0	0	0	0	0	0	B0	
	DARK	0	0	0	0	0	0	0	0	0	0	0	0	0	0	0	0	1	0	0	0	0	0	0	B1	
		0	0	0	0	0	0	0	0	0	0	0	0	0	0	0	0	1	0	0	0	0	0	0	B2	
		:	:	:	:	:	:	:	:	:	:	:	:	:	:	:	:	:	:	:	:	:	:	:	B3~B252	
		:	:	:	:	:	:	:	:	:	:	:	:	:	:	:	:	:	:	:	:	:	:	:		
	LIGHT	0	0	0	0	0	0	0	0	0	0	0	0	0	0	0	0	1	0	1	1	1	1	1	B253	
		0	0	0	0	0	0	0	0	0	0	0	0	0	0	0	0	1	1	1	1	1	1	1	B254	
	BLUE	0	0	0	0	0	0	0	0	0	0	0	0	0	0	0	0	1	1	1	1	1	1	1	B255	

Note) Definition of Gray :

Rn : Red Gray, Gn : Green Gray, Bn : Blue Gray (n = Gray level)

Input Signal : 0 = Low level voltage, 1 = High level voltage

MODEL	LTI520HB01-001	Doc. No	05-001-G-071128	Page	17 / 27
-------	----------------	---------	-----------------	------	---------

6. Interface Timing

6.1 Timing Parameters (DE only mode)

Signal	Item	Symbol	Min.	Typ.	Max.	Unit	Note
Clock	Frequency	$1/T_C$	130.0	148.5	155.0	MHz	-
Hsync		F_H	50.0	67.5	75.0	KHz	-
Vsync		F_V	48	60	62	Hz	-
Vertical Display Term	Active Display Period	T_{VD}	-	1080	-	Lines	-
	Vertical Total	T_V	1100	1125	1480	Lines	-
Horizontal Display Term	Active Display Period	T_{HD}	-	1920	-	Clocks	-
	Horizontal Total	T_H	2150	2200	2350	Clocks	-

Note) This product is DE only mode. The input of Hsync & Vsync signal does not have an effect on normal operation.
Test Point : TTL control signal and CLK at LVDS Tx input terminal in system

6.2 Timing diagrams of interface signal (DE only mode)

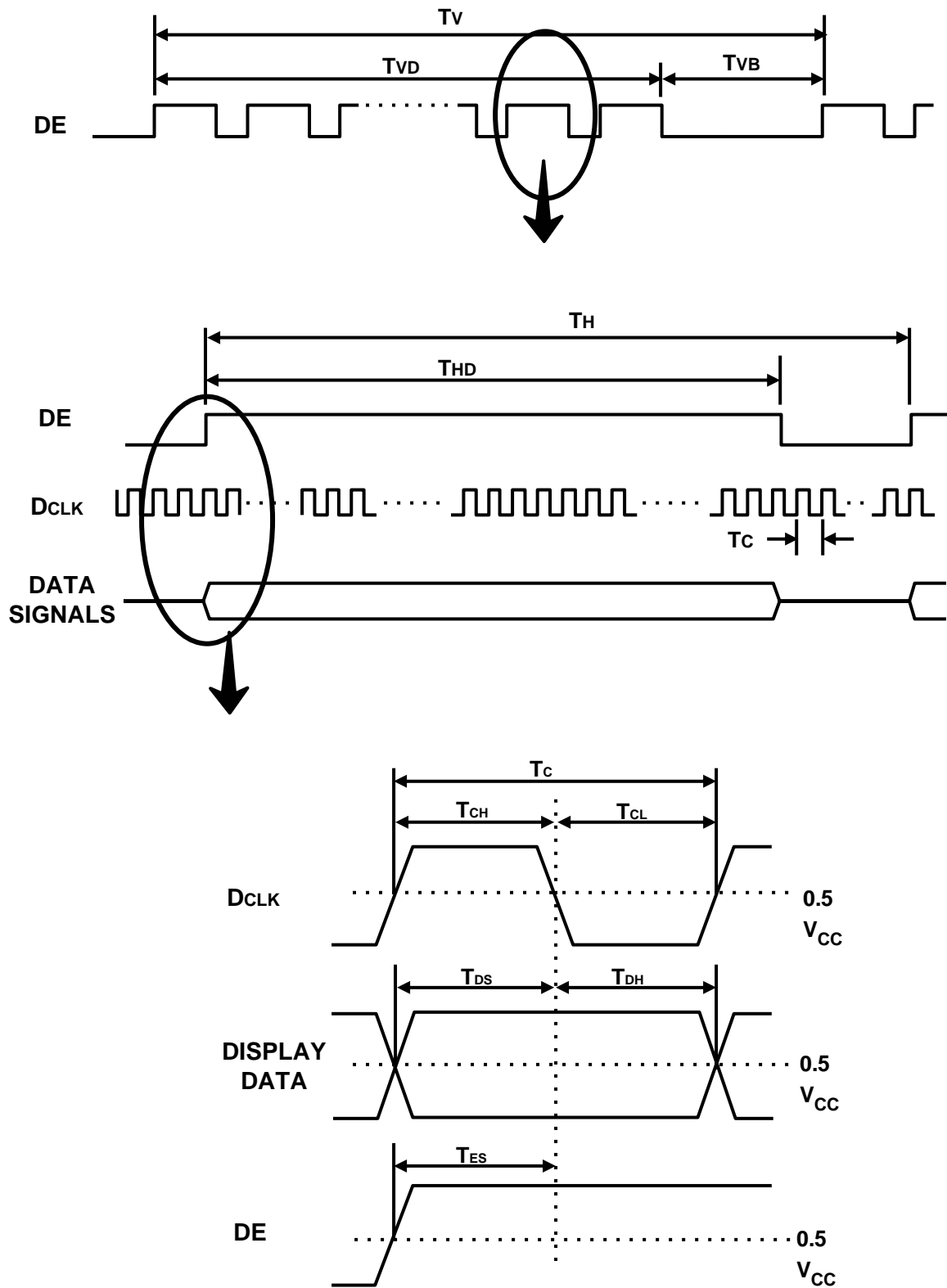

6.3 Power ON/OFF Sequence

To prevent a latch-up or DC operation of the LCD Module, the power on/off sequence should be as the diagram below.

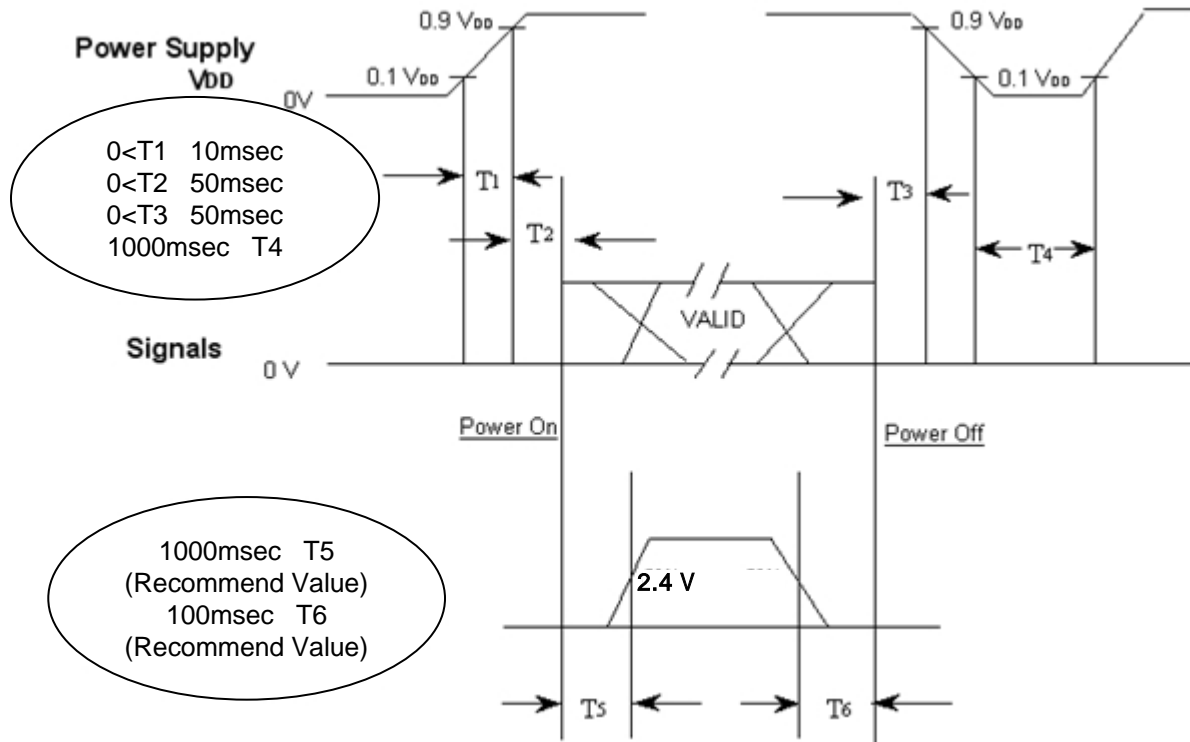

- T1 : V_{DD} rising time from 10% to 90%
- T2 : The time from V_{DD} to valid data at power ON.
- T3 : The time from valid data off to V_{DD} off at power Off.
- T4 : V_{DD} off time for Windows restart
- T5 : The time from valid data to B/L enable at power ON.
- T6 : The time from valid data off to B/L disable at power Off.

- The supply voltage of the external system for the Module input should be the same as the definition of V_{DD} .
- Apply the lamp voltage within the LCD operation range. When the back light turns on before the LCD operation or the LCD turns off before the back light turns off, the display may momentarily show abnormal screen.
- In case of V_{DD} = off level, please keep the level of input signals low or keep a high impedance.
- T4 should be measured after the Module has been fully discharged between power off and on period.
- Interface signal should not be kept at high impedance when the power is on.

7. Outline Dimension (Front View)

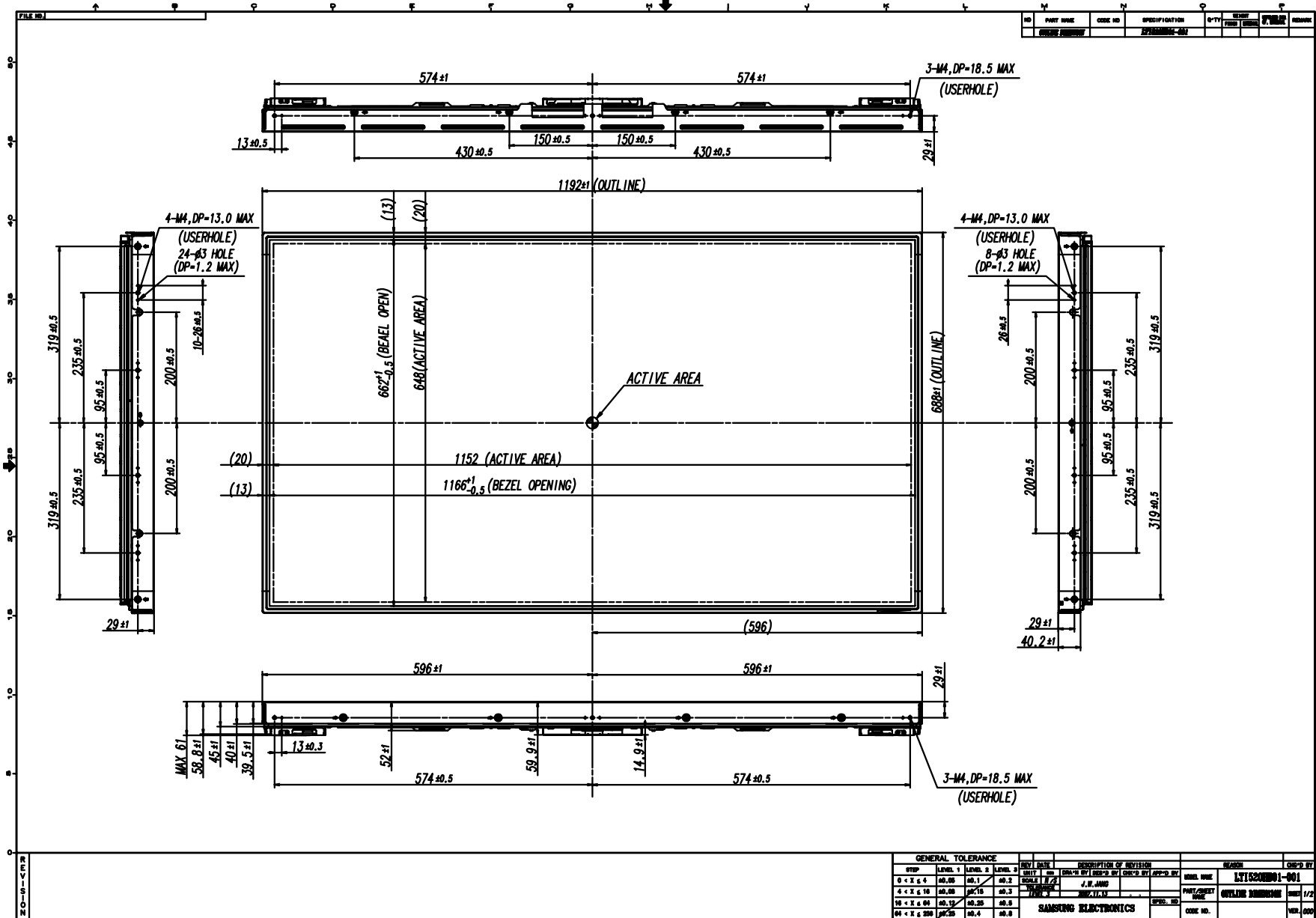

www.DataSheet4U.net

Model

LTI520HB01-001

Doc. No

05-001-G-071128

Page

21 / 27

8. PACKING

8.1 CARTON (Internal Package)

(1) Packing Form

Corrugated fiberboard box and corrugated cardboard as shock absorber

(2) Packing Method

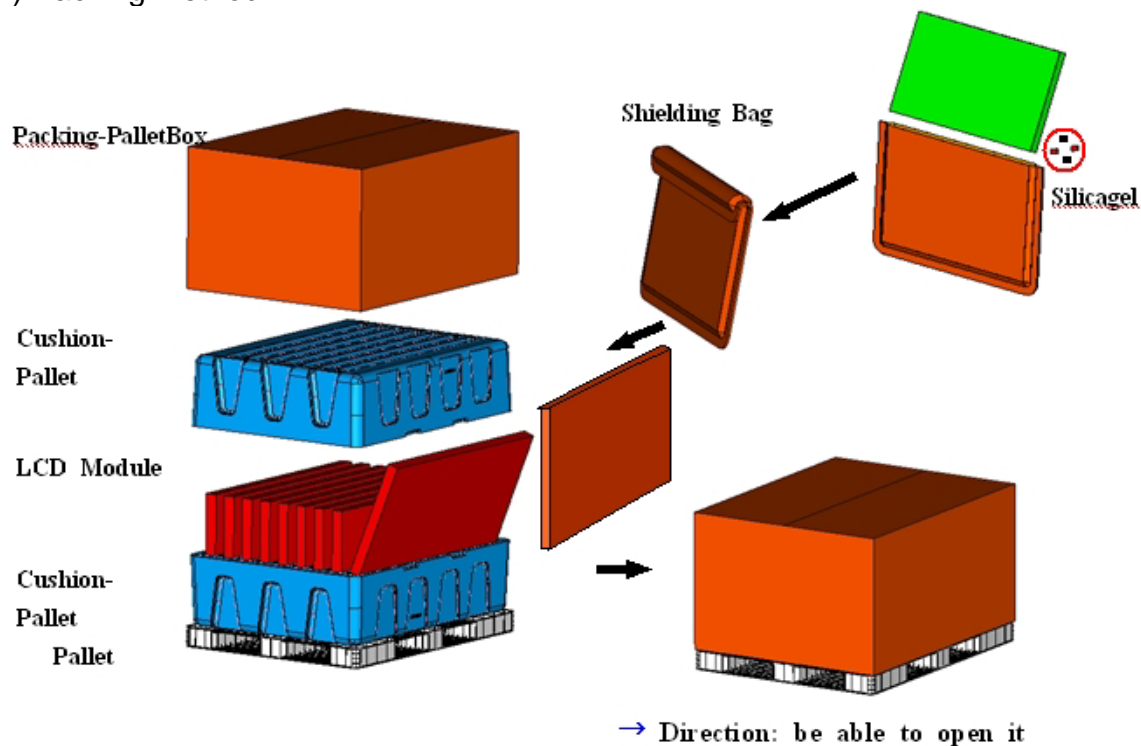

8.2 Packing Specification

Item	Specification	Remark
LCD Packing	9ea / (Packing-Pallet Box)	1. 207Kg / LCD (9ea) 2. 16 Kg / Cushion-pallet (2ea) 3. 10.5 Kg / Packing-Pallet Box (1ea) 4. Cushion-pallet Material : EPS 5. Packing-Pallet Box Material : DW4
Pallet	1Box / Pallet	1. Pallet weight = 10kg
Packing Direction	Vertical	
Total Pallet Size	H x V x height	1475mm(H) x 1150mm(V) x 995mm(height)
Total Pallet Weight	243.5Kg	Pallet(10kg) + Module (23*9=207kg) + Cushion (up + bottom=16kg) + Pallet-Box(10.5kg)

9. MARKING & OTHERS

A nameplate bearing followed by is affixed to a shipped product at the specified location on each product.

- (1) Part number : LTI520HB01-001
- (2) Revision: Three letters
- (3) Lot number : X X X X XXX XX X

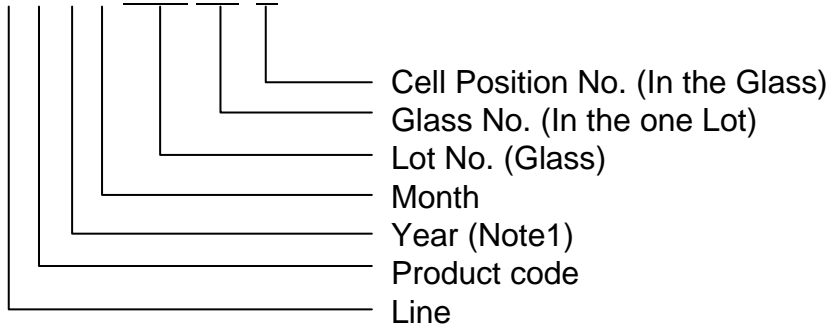

(4) Nameplate Indication

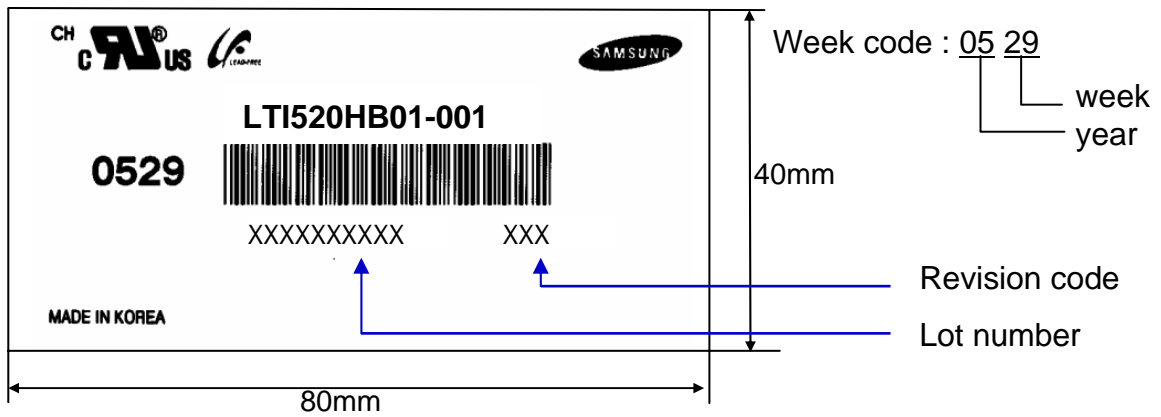

(5) Packing box attach



(6) Others

- 1. After service part
 Lamps cannot be replaced because of the narrow bezel structure.

MODEL	LTI520HB01-001	Doc. No	05-001-G-071128	Page	24 / 27
-------	----------------	---------	-----------------	------	---------

10. General Precautions

10.1 Handling

- (a) When the Module is assembled, it should be attached to the system firmly using all mounting holes. Be careful not to twist and bend the Module.
- (b) Because the inverter use high voltage, it should be disconnected from power before it is assembled or disassembled.
- (c) Refrain from strong mechanical shock and / or any force to the Module.
In addition to damage, this may cause improper operation or damage to the Module and CCFT back light.
- (d) Note that polarizers are very fragile and could be damage easily.
Do not press or scratch the surface harder than a HB pencil lead.
- (e) Wipe off water droplets or oil immediately. If you leave the droplets for a long time, staining or discoloration may occur.
- (f) If the surface of the polarizer is dirty, clean it using absorbent cotton or soft cloth.
- (g) Desirable cleaners are water, IPA(Isopropyl Alcohol) or Hexane.
Do not use Ketone type materials(ex. Acetone), Ethyl alcohol, Toluene, Ethyl acid or Methyl chloride. It might permanent damage to the polarizer due to chemical reaction.
- (h) If the liquid crystal material leaks from the panel, it should be kept away from the eyes or mouth . In case of contact with hands, legs or clothes, it must be washed away with soap thoroughly.
- (i) Protect the Module from static, or the CMOS Gate Array IC would be damaged.
- (j) Use finger-stalls with soft gloves in order to keep display clean during the incoming inspection and assembly process.
- (k) Do not disassemble the Module.
- (l) Do not pull or fold the lamp wire.
- (m) Do not adjust the variable resistor located on the Module.
- (n) Protection film for polarizer on the Module should be slowly peeled off just before use so that the electrostatic charge can be minimized.
- (o) Pins of I/F connector should not be touched directly with bare hands.

MODEL	LTI520HB01 - 001	Doc. No	05-001 - G - 071128	Page	25 / 27
-------	------------------	---------	---------------------	------	---------

10.2 Storage

- (a) Do not leave the Module in high temperature, and high humidity for a long time. It is highly recommended to store the Module with temperature from 0 to 35 and relative humidity of less than 70%.
- (b) Do not store the TFT-LCD Module in direct sunlight.
- (c) The Module should be stored in a dark place. It is prohibited to apply sunlight or fluorescent light in storing.

10.3 Operation

- (a) Do not connect or disconnect the Module in the "Power On" condition.
- (b) Power supply should always be turned on/off by the "Power on/off sequence"
- (c) Module has high frequency circuits. Sufficient suppression to the electromagnetic interference should be done by system manufacturers. Grounding and shielding methods may be important to minimize the interference.
- (d) The cable between the back light connector and its inverter power supply should be connected directly with a minimized length. A longer cable between the back light and the inverter may cause lower luminance of lamp(CCFT) and may require higher startup voltage(Vs).

10.4 Operation Condition Guide

- (a) The LCD product should be operated under normal conditions. Normal condition is defined as below;
 - Temperature : 20 ± 15
 - Humidity : $55 \pm 20\%$
 - Display pattern : continually changing pattern (Not stationary)
- (b) If the product will be used in extreme conditions such as high temperature, humidity, display patterns or operation time etc., It is strongly recommended to contact SEC for Application engineering advice. Otherwise, its reliability and function may not be guaranteed. Extreme conditions are commonly found at Airports, Transit Stations, Banks, Stock market, and Controlling systems.

MODEL	LTI520HB01 - 001	Doc. No	05 - 001 - G - 071128	Page	26 / 27
-------	------------------	---------	-----------------------	------	---------

10.5 Others

- (a) Ultra-violet ray filter is necessary for outdoor operation.
- (b) Module should be turned clockwise (regular front view perspective) when used in portrait mode
- (c) Avoid condensation of water. It may result in improper operation or disconnection of electrode.
- (d) Do not exceed the absolute maximum rating value. (supply voltage variation, input voltage variation, variation in part contents and environmental temperature, and so on)
Otherwise the Module may be damaged.
- (e) If the Module keeps displaying the same pattern for a long period of time, the image may be "sticked" to the screen.
To avoid image sticking, it is recommended to use a screen saver.
- (f) This Module has its circuitry PCB's on the rear side and should be handled carefully in order not to be stressed.
- (g) Please contact SEC in advance when you display the same pattern for a long time.

MODEL

LTI520HB01-001

Doc. No

05-001-G-071128

Page

27 / 27