

## Silicon Controlled Rectifiers

### Features

- Repetitive Peak Off-State Voltage : 600V
- R.M.S On-State Current (  $I_{T(RMS)}$  )= 6 A )
- Low On-State Voltage (1.4V(Typ.) @  $I_{TM}$ )
- Isolation Voltage( $V_{ISO}$ =1500V AC)

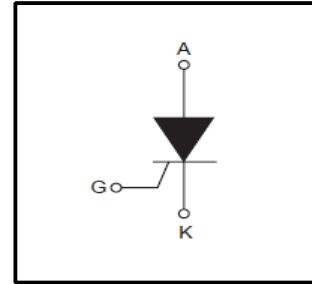

### General Description

Standard gate triggering SCR is fully isolated package suitable for the application where requiring high bidirectional blocking voltage capability and also suitable for over voltage protection ,motor control circuit in power tool, inrush current limit circuit and heating control system.



### Absolute Maximum Ratings ( $T_J = 25^\circ\text{C}$ unless otherwise specified)

Symbol	Parameter	Condition	Ratings	Units
$V_{DRM}$	Repetitive Peak Off-State Voltage		600	V
$I_{T(AV)}$	Average On-State Current(180° Conduction Angle)	$T_c = 110^\circ\text{C}$	3.8	A
$I_{T(RMS)}$	R.M.S On-State Current(180° Conduction Angle)	$T_c = 110^\circ\text{C}$	6	A
$I_{TSM}$	Surge On-State Current	1/2 Cycle, 60Hz, Sine Wave Non-Repetitive	66	A
$I^2t$	$I^2t$ for Fusing	$t = 10\text{ms}$	21	$\text{A}^2\text{s}$
$di/dt$	Critical rate of rise of on-state current	$F=60\text{Hz}, T_J=125^\circ\text{C}$	50	$\text{A}/\mu\text{s}$
$P_{GM}$	Forward Peak Gate Power Dissipation		5	W
$P_{G(AV)}$	Forward Average Gate Power Dissipation	$T_J=125^\circ\text{C}$	0.5	W
$I_{FGM}$	Forward Peak Gate Current		2	A
$V_{RGM}$	Reverse Peak Gate Voltage		5.0	V
$V_{ISO}$	Isolation Breakdown voltage(R.M..S)	A,C.1minute	1500	V
$T_J$	Operating Junction Temperature		-40~125 °C	°C
$T_{STG}$	Storage Temperature		-40~150 °C	°C

### Thermal Characteristics

Symbol	Parameter	Value	Units
$R_{\theta Jc}$	Thermal Resistance Junction to Case(DC)	3.12	$^\circ\text{C}/\text{W}$
$R_{\theta JA}$	Thermal Resistance Junction to Ambient(DC)	89	$^\circ\text{C}/\text{W}$

**Electrical Characteristics** ( $T_C=25^\circ\text{C}$  unless otherwise noted)

Symbol	Parameter	Test Conditions	Value			Units
			Min	Typ	Max	
$I_{\text{DRM}}$	Repetitive Peak Off-State Current	$V_{\text{AK}}=V_{\text{DRM}}$ $T_C=25^\circ\text{C}$	-	-	10	$\mu\text{A}$
		$T_C=125^\circ\text{C}$	-	-	200	$\mu\text{A}$
$V_{\text{TM}}$	Peak On-State Voltage (1)	$I_{\text{TM}}=9\text{A}$ , $t_p=380\mu\text{s}$	-	1.4	1.6	V
$I_{\text{GT}}$	Gate Trigger Current (2)	$V_{\text{AK}}=6\text{V(DC)}$ , $R_L=10\Omega$ $T_C=125^\circ\text{C}$	-	-	15	mA
$V_{\text{GT}}$	Gate Trigger Voltage (2)	$V_D=6\text{V(DC)}$ , $R_L=10\Omega$ $T_C=125^\circ\text{C}$	-	-	1.5	V
$V_{\text{GD}}$	Non-Trigger Gate Voltage (1)	$V_{\text{AK}}=12\text{V}$ , $R_L=100\Omega$ $T_C=125^\circ\text{C}$	0.2			V
dv/dt	Critical Rate of Rise Off-State Voltage	Linear slope up to $V_D=67\%V_{\text{DRM}}$ , gate open $T_J=125^\circ\text{C}$	200	-	-	V/ $\mu\text{s}$
$I_{\text{H}}$	Holding Current	$I_T=100\text{mA}$ , Gate open $T_C=25^\circ\text{C}$	-	-	20	mA
$I_{\text{L}}$	Latching Current	$I_G=1.2 I_{\text{GT}}$	-	50	-	mA

**\*Notes:**

- 1.Pulse Width  $\leq 1.0\text{ms}$ , Duty cycle  $\leq 1\%$
2. $R_{\text{GK}}$  Current not Included in measurement.

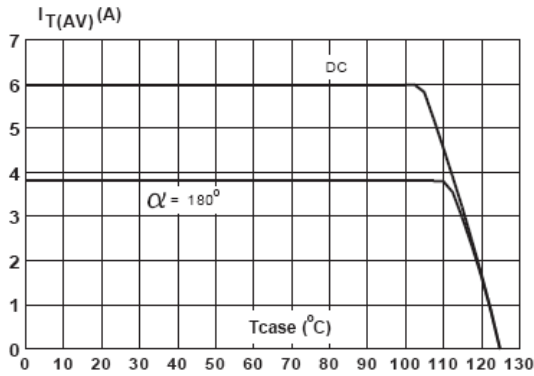

**Fig. 1** Average on -State current versus case temperature

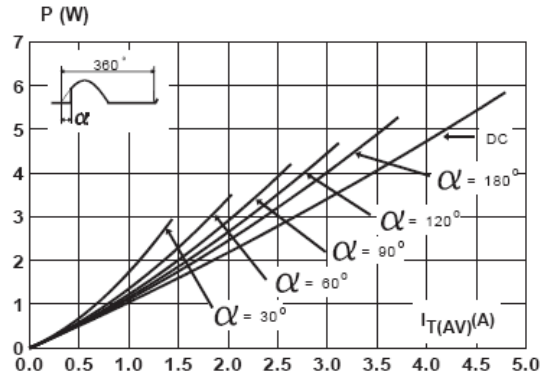

**Fig. 2** Correlation between maximum average power dissipation and maximum allowable temperatures ( $t_{amb}$  and  $t_{case}$ ) for different thermal resistances heatsink+contact

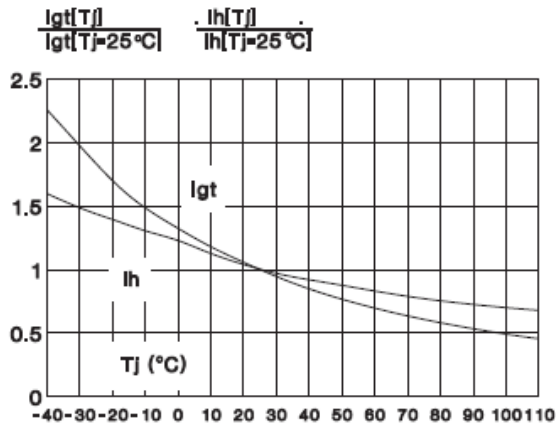

**Fig. 3** Relative variation of gate trigger current and holding current versus junction temperature

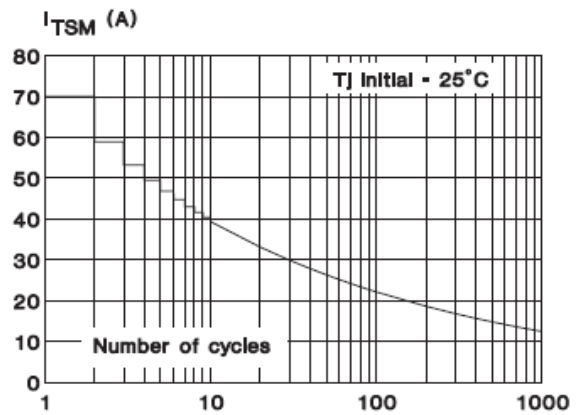

**Fig. 4** Maximum permissible non -repetitive peak on-state current  $I_{TSM}$ , versus number of cycles, for sinusoidal currents.  $f=60\text{Hz}$

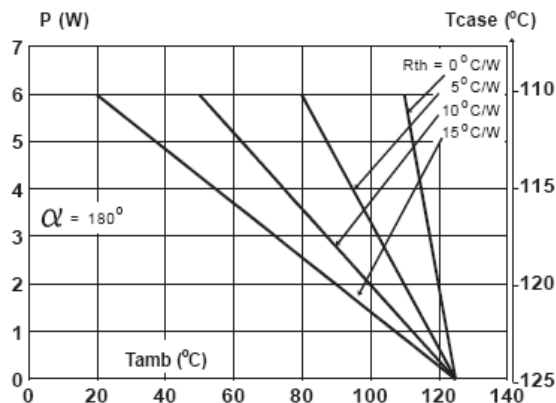

**Fig. 5** Correlation between Maximum average Power dissipation and Maximum allowable temperatures ( $t_{amb}$  and  $t_{case}$ ) for different thermal resistances heatsink+contact.

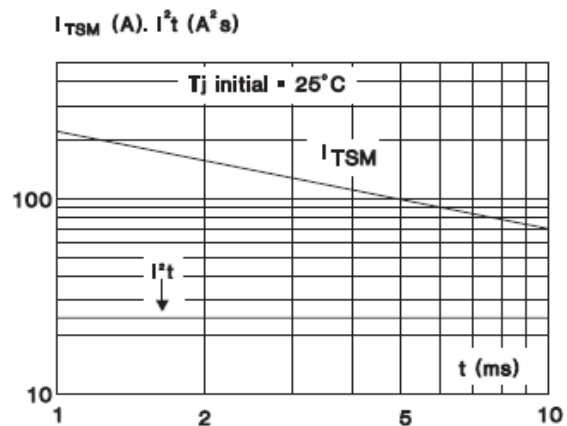

**Fig. 6** Non-repetitive surge peak on-state current for a sinusoidal pulse with width  $T_p \leq 10\text{ms}$  and corresponding value of  $I^2 t$

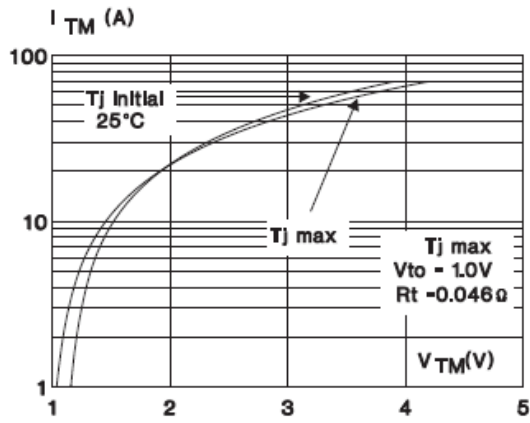

**Fig.7** On-state characteristics(maximum values)

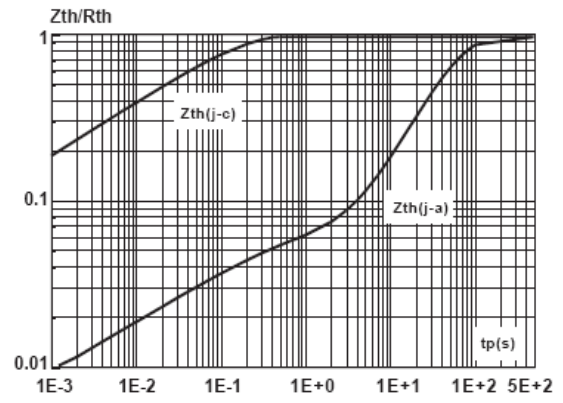

**Fig.8** Transient thermal impedance  $Z_{th\ j-mb}$ , Versus pulse width  $t_p$

**TO-252 Package Dimension**

**Unit: mm**

