

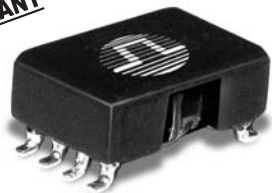



# HOME PHONE NETWORKING TRANSFORMER



-  Matched to Coppergate's HPNA3 chipset
-  Small form factor
-  For use in Gateways, Set-Top Boxes, and ONTs
-  Excellent return loss

## Electrical Specifications @ 25°C — Operating Temperature -40°C to +85°C

Part Number	Turns Ratio (±2%) (1-4):(5-8)	Inductance (@ 100kHz, 0.1Vrms)	Leakage Inductance (@ 100kHz, 0.1Vrms) (1-4) with (5-8) shorted	DC Resistance (1-4)	DC Resistance (5-8)	Interwinding Capacitance (@ 100kHz, 0.1Vrms)	Isolation Voltage (Vrms)
B6104NL	1:1	100µH MIN	0.5µH MAX	0.50Ω MAX	0.50Ω MAX	20pF MAX	1500
B6105NL	1.33:1	177µH MIN	0.5µH MAX	0.60Ω MAX	0.40Ω MAX	15pF MAX	1500
B6106NL	1.15:1	177µH MIN	0.5µH MAX	0.60Ω MAX	0.40Ω MAX	15pF MAX	1500

NOTE: Transformers are shipped in tubes, unless Tape & Reel packaging is specified by adding a "T" suffix to the part number (ex: B6104NLT).

## Mechanical

## Schematic

### B6104NL/ B6105NL/ B6106NL

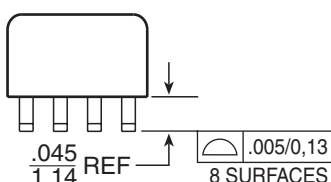
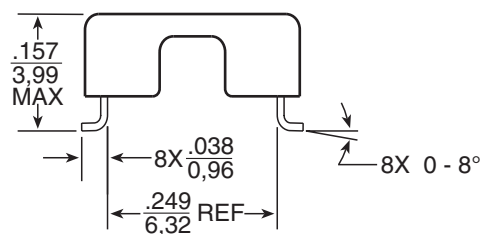
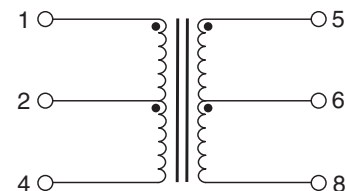
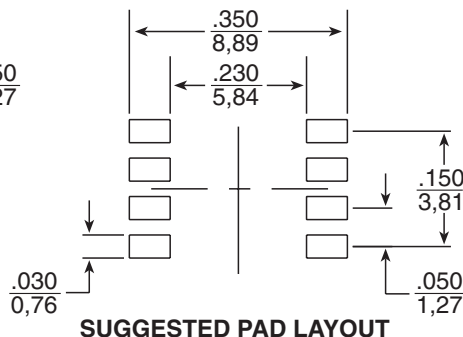
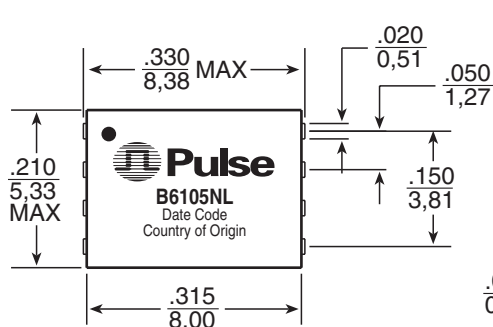

Weight . . . . . 0.2 grams  
Tape & Reel . . . . . .95/reel  
Tube . . . . . .300/tube

Dimensions:  $\frac{\text{Inches}}{\text{mm}}$   
Unless otherwise specified, all tolerances are  $\pm \frac{.010}{0.25}$

## For More Information:

### Pulse Worldwide Headquarters

12220 World Trade Dr.  
San Diego, CA 92128  
U.S.A.  
[www.pulseeng.com](http://www.pulseeng.com)

Tel: 858 674 8100  
Fax: 858 674 8262

### Pulse Europe

Einsteinstrasse 1  
D-71083 Herrenberg  
Germany

Tel: 49 7032 7806 0  
Fax: 49 7032 7806 12

### Pulse China Headquarters

B402, Shenzhen  
Tech-Innovation International  
Tenth Kejinan Rd.  
High-Tech Industrial Park  
Nanshan District, Shenzhen  
China

Tel: 86 755 33966678  
Fax: 86 755 33966700

### Pulse North China

Room 1503  
XinYin Building  
No. 888 YiShan Rd.  
Shanghai 200233  
China

Tel: 86 21 54643211/2  
Fax: 86 21 54643210

### Pulse South Asia

150 Kampong Ampat  
#07-01/02  
KA Centre  
Singapore 368324

Tel: 65 6287 8998  
Fax: 65 6280 0080

### Pulse North Asia

No. 26  
Kao Ching Rd.  
Yang Mei Chen  
Taoyuan Hsien  
Taiwan, R. O. C.

Tel: 886 3 4641811  
Fax: 886 3 4641911

Performance warranty of products offered on this data sheet is limited to the parameters specified. Data is subject to change without notice. Other brand and product names mentioned herein may be trademarks or registered trademarks of their respective owners. © Copyright, 2007. Pulse Engineering, Inc. All rights reserved.