

## General Description

The MIC35152 is a 1.5A low-dropout linear voltage regulator that provides a low voltage, high current output with a minimum of external components. It offers high precision, ultra-low dropout (600mV over temperature), and low ground current.

The MIC35152 operates from an input of 2.25V to 6.0V. It is designed to drive digital circuits requiring low voltage at high currents (i.e., PLDs, DSPs, micro-controllers, etc.), providing an adjustable output voltage from 1.24V to 5.4V.

Features of the MIC35152 LDO include current limiting and thermal protection, and reverse current and reverse battery protection. Also logic (active-HIGH) enable pin is included. The MIC35152 is available in a 5-pin power D-Pak package (TO-252) with an operating temperature range of  $-40^{\circ}\text{C}$  to  $+125^{\circ}\text{C}$ .

Data sheets and support documentation can be found on Micrel's web site at [www.micrel.com](http://www.micrel.com).

## Features

- 1.5A minimum guaranteed output current
- 600mV maximum dropout voltage over temperature
  - **Ideal for 3.0V to 2.5V conversion**
  - **Ideal for 2.5V to 1.8V, 1.65V, or 1.5V conversion**
- Stable with ceramic or tantalum capacitor
- Wide input voltage range
  - $V_{\text{IN}}$ : 2.25V to 6.0V
- $\pm 1.0\%$  initial output tolerance
- Excellent line and load regulation specifications
- Logic controlled shutdown
- Thermal shutdown and current limit protection
- Reverse-leakage protection
- $-40^{\circ}\text{C}$  to  $+125^{\circ}\text{C}$  junction temperature
- Power D-Pak package (TO-252)

## Applications

- LDO linear regulator for low-voltage digital IC
- PC add-in cards
- High efficiency linear power supplies
- SMPS post regulator
- Battery charger

## Typical Application\*\*

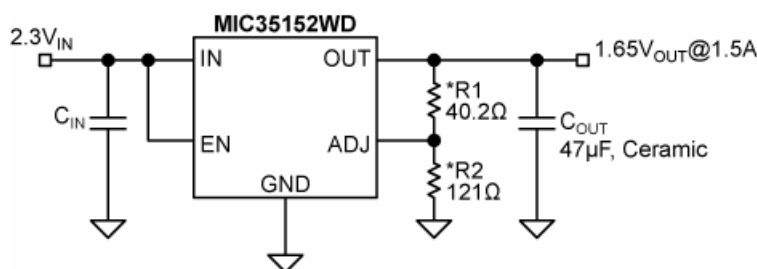

**Adjustable Regulator Application**

(\*See Minimum Load Current Section)

## Ordering Information

Part Number	Output Current	Voltage	Junction Temp. Range(1)	Package
MIC35152WD*	1.5A	Adjustable	-40° to +125°C	5-Pin TO-252

**Note:**

\*RoHS compliant with 'high-melting solder' exemption.

## Pin Configuration

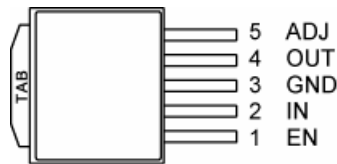

5-Pin TO-252 D-Pak (D)

## Pin Description

Pin Number	Pin Name	Pin Function
1	EN	Enable (Input): CMOS compatible input. Logic high = enable, logic low = shutdown.
2	IN	Input Voltage: Supplies the current to the output power device
3	GND, TAB	Ground: TAB is also connected internally to the IC's ground on D-PAK.
4	OUT	Regulator Output: The output voltage is set by the resistor divider connected from OUT to GND (with the divided connection tied to ADJ). A minimum value capacitor must be used to maintain stability. See Applications Information.
5	ADJ	Adjustable Regulator Feedback Input: Connect to the resistor voltage divider that is placed from OUT to GND in order to set the output voltage.

### Absolute Maximum Ratings<sup>(1)</sup>

Supply Voltage (V <sub>IN</sub> ).....	-0.3V to +6.5V
Enable Input Voltage (V <sub>EN</sub> ).....	-0.3V to +6.5V
Power Dissipation .....	Internally Limited
Junction Temperature .....	-40°C ≤ T <sub>J</sub> ≤ +125°C
Storage Temperature (T <sub>s</sub> ) .....	-65°C ≤ T <sub>J</sub> ≤ +150°C
Lead Temperature (soldering, 5sec.).....	260°C
ESD Rating.....	<b>Note 3</b>

### Operating Ratings<sup>(2)</sup>

Supply voltage (V <sub>IN</sub> ) .....	+2.25V to +6.0V
Enable Input Voltage (V <sub>EN</sub> ).....	0V to +6.0V
Junction Temperature Range .....	-40°C ≤ T <sub>J</sub> ≤ +125°C
Maximum Power Dissipation.....	<b>Note 4</b>
Package Thermal Resistance	
TO-252 (θ <sub>JC</sub> ) .....	3°C/W
TO-252 (θ <sub>JA</sub> ) .....	56°C/W

### Electrical Characteristics<sup>(5)</sup>

T<sub>J</sub> = 25°C with V<sub>IN</sub> = V<sub>EN</sub> = V<sub>OUT</sub> + 1V; I<sub>OUT</sub> = 10mA; **bold** values indicate -40°C < T<sub>J</sub> < +125°C, unless otherwise noted.

Parameter	Condition	Min	Typ	Max	Units
Output Voltage Line Regulation	V <sub>IN</sub> = V <sub>OUT</sub> + 1.0V to 6.0V		0.06	0.5	%
Output Voltage Load Regulation	I <sub>OUT</sub> = 10mA to 1.5A		0.2	1	%
Dropout Voltage, V <sub>IN</sub> - V <sub>OUT</sub> <b>Note 6</b>	I <sub>OUT</sub> = 750mA		225	<b>350</b>	mV
	I <sub>OUT</sub> = 1.5A		365	<b>600</b>	mV
Ground Pin Current, <b>Note 7</b>	I <sub>OUT</sub> = 1.5A		11	<b>30</b>	mA
Ground Pin Current in Shutdown	V <sub>IL</sub> ≤ 0.5V, V <sub>IN</sub> = V <sub>OUT</sub> + 1V		1.0		μA
Current Limit	V <sub>OUT</sub> = 0		2.7	<b>4.0</b>	A
Start-up Time	V <sub>EN</sub> = V <sub>IN</sub> , I <sub>OUT</sub> = 10mA, C <sub>OUT</sub> = 47μF		45	<b>150</b>	μs
<b>Enable Input</b>					
Enable Input Threshold	Regulator enable	<b>2.25</b>			V
	Regulator shutdown			<b>0.8</b>	V
Enable Pin Input Current	V <sub>IL</sub> ≤ 0.8V (regulator shutdown)			2 <b>4</b>	μA μA
	V <sub>IH</sub> ≥ 2.25V (regulator enabled)	1	15	30 <b>75</b>	μA μA

### Adjust Pin

Reference Voltage		1.228	1.240	1.252	V
		<b>1.215</b>		<b>1.265</b>	V
Reference Voltage Temp. Coefficient	<b>Note 8</b>		<b>20</b>		ppm/°C
Adjust Pin Bias Current			40	80 <b>120</b>	nA nA
Adjust Pin Bias Current Temp. Coefficient			0.1		nA/°C

### Notes:

- Exceeding the absolute maximum rating may damage the device.
- The device is not guaranteed to function outside its operating rating.
- Devices are ESD sensitive. Handling precautions recommended.
- P<sub>D(MAX)</sub> = (T<sub>J(MAX)</sub> - T<sub>A</sub>) / θ<sub>JA</sub>, where θ<sub>JA</sub>, depends upon the printed circuit layout. See "Applications Information."
- Specification for packaged product only.
- V<sub>DO</sub> = V<sub>IN</sub> - V<sub>OUT</sub> when V<sub>OUT</sub> decreased to 98% of its nominal output voltage with V<sub>IN</sub> = V<sub>OUT</sub> + 1V. For output voltages below 1.75V, dropout voltage specification does not apply due to a minimum input operating voltage of 2.25V.
- I<sub>GND</sub> is the quiescent current. I<sub>IN</sub> = I<sub>GND</sub> + I<sub>OUT</sub>.
- Thermal regulation is defined as the change in output voltage at a time t after a change in power dissipation is applied, excluding load or line regulation effects. Specifications are for a 200mA load pulse at V<sub>IN</sub> = 6V for t = 10ms.

# Typical Characteristics

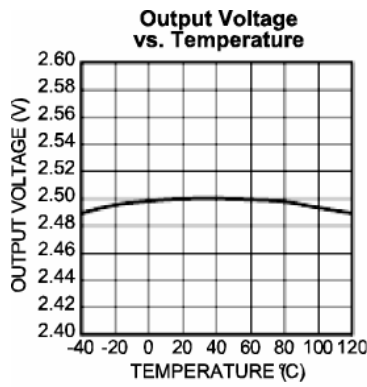
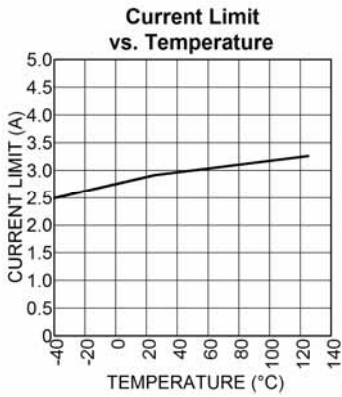
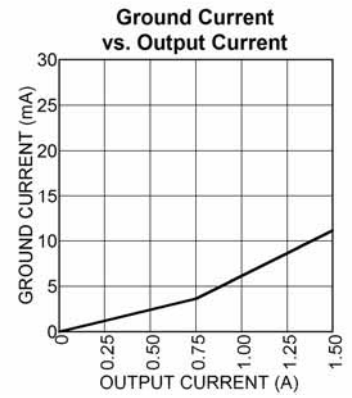
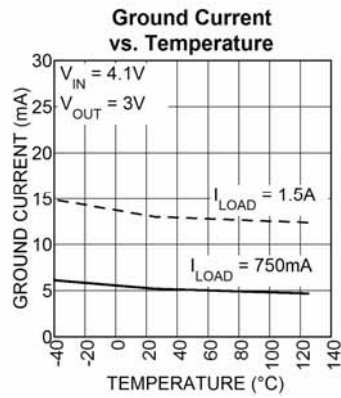
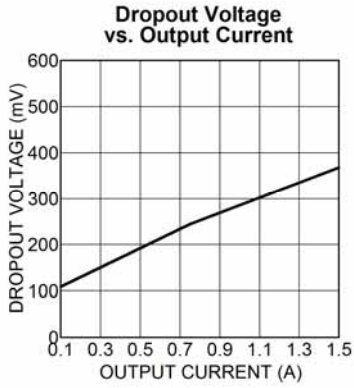
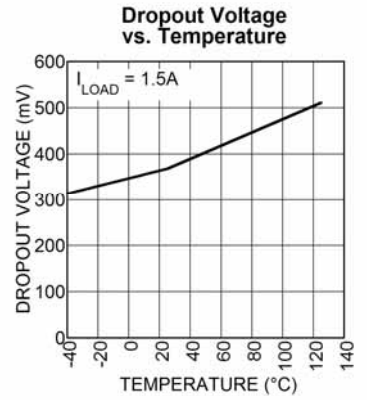
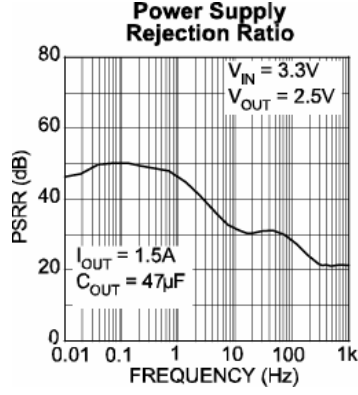
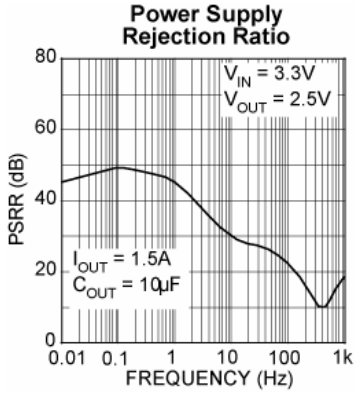

# Functional Characteristics

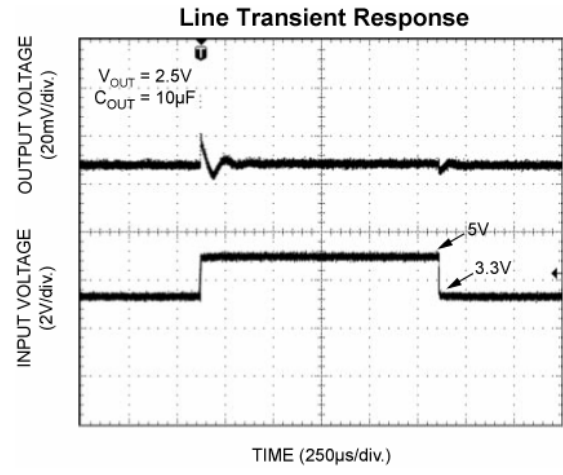
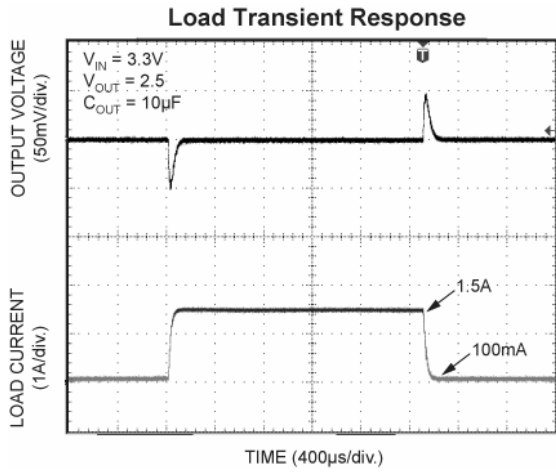

## Application Information

The MIC35152 is a high-performance low-dropout voltage regulator suitable for moderate to high-current regulator applications. Its 600mV dropout voltage at full load and over-temperature makes it especially valuable in battery-powered systems and as high-efficiency noise filters in post-regulator applications. Unlike older NPN-pass transistor designs, there the minimum dropout voltage is limited by the based-to-emitter voltage drop and collector-to-emitter saturation voltage, dropout performance of the PNP output of these devices is limited only by the low  $V_{CE}$  saturation voltage.

A trade-off for the low dropout voltage is a varying base drive requirement. Micrel's Super  $\beta$  PNP<sup>®</sup> process reduces this drive requirement to only 2% to 5% of the load current.

The MIC35152 regulator is fully protected from damage due to fault conditions. Current limiting is provided. This limiting is linear; output current during overload conditions is constant. Thermal shutdown disables the device when the die temperature exceeds the maximum safe operating temperature. Transient protection allows device (and load) survival even when the input voltage spikes above and below nominal. The output structure of these regulators allows voltages in excess of the desired output voltage to be applied without reverse current flow.

### Thermal Design

Linear regulators are simple to use. The most complicated design parameters to consider are thermal characteristics. Thermal design requires the following application-specific parameters:

- Maximum ambient temperature ( $T_A$ )
- Output current ( $I_{OUT}$ )
- Output voltage ( $V_{OUT}$ )
- Input voltage ( $V_{IN}$ )
- Ground current ( $I_{GND}$ )

First, calculate the power dissipation of the regulator from these numbers and the device parameters from this datasheet.

$$P_D = (V_{IN} - V_{OUT})I_{OUT} + V_{IN} I_{GND}$$

Where the ground current is approximated by using numbers from the "Electrical Characteristics" or "Typical Characteristics." Then, the heat sink thermal resistance is determined with this formula:

$$\theta_{SA} = ((T_{J(MAX)} - T_A) / P_D) - (\theta_{JC} + \theta_{CS})$$

Where  $T_{J(MAX)} \leq 125^\circ\text{C}$  and  $\theta_{CS}$  is between  $0^\circ\text{C}$  and  $2^\circ\text{C/W}$ . The heat sink may be significantly reduced in applications where the minimum input voltage is known and is large compared with the dropout voltage. Use a series input resistor to drop excessive voltage and distribute the heat between this resistor and the regulator. The low dropout properties of Micrel Super  $\beta$  PNP<sup>®</sup> regulators allow significant reductions in

regulator power dissipation and the associated heat sink without compromising performance. When this technique is employed, a capacitor of at least  $1.0\mu\text{F}$  is needed directly between the input and regulator ground.

Refer to "Application Note 9" for further details and examples on thermal design and heat sink applications.

With no heat sink in the application, calculate the junction temperature to determine the maximum power dissipation that will be allowed before exceeding the maximum junction temperature of the MIC35152. The maximum power allowed can be calculated using the thermal resistance ( $\theta_{JA}$ ) of the D-Pak adhering to the following criteria for the PCB design: 2 oz. copper and  $100\text{mm}^2$  copper area for the MIC35152.

As an example, given an expected maximum ambient temperature ( $T_A$ ) of  $75^\circ\text{C}$  with  $V_{IN} = 2.25\text{V}$ ,  $V_{OUT} = 1.75\text{V}$ , and  $I_{OUT} = 1.5\text{A}$ , first calculate the expected  $P_D$  using Equation (1);

$$P_D = (2.25\text{V} - 1.75\text{V})1.5\text{A} + (2.25\text{V})(0.027\text{A}) = 0.811\text{W}$$

Next, calculate the junction temperature for the expected power dissipation.

$$T_J = (\theta_{JA} \times P_D) + T_A = (56^\circ\text{C/W} \times 0.811\text{W}) + 75^\circ\text{C} = 120.4^\circ\text{C}$$

Now determine the maximum power dissipation allowed that would not exceed the IC's maximum junction temperature ( $125^\circ\text{C}$ ) without the use of a heat sink by

$$P_{D(MAX)} = (T_{J(MAX)} - T_A) / \theta_{JA} = (125^\circ\text{C} - 75^\circ\text{C}) / (56^\circ\text{C/W}) = 0.893\text{W}$$

### Output Capacitor

The MIC35152 requires an output capacitor for stable operation. As a  $\mu\text{Cap}$  LDO, the MIC35152 can operate with ceramic output capacitors as long as the amount of capacitance is  $47\mu\text{F}$  or greater. For values of output capacitance lower than  $47\mu\text{F}$ , the recommended ESR range is  $200\text{m}\Omega$  to  $2\Omega$ . The minimum value of output capacitance recommended for the MIC35152 is  $10\mu\text{F}$ .

For  $47\mu\text{F}$  or greater, the ESR range recommended is less than  $1\Omega$ . Ultra-low ESR ceramic capacitors are recommended for output capacitance of  $47\mu\text{F}$  or greater to help improve transient response and noise reduction at high frequency. X7R/X5R dielectric-type ceramic capacitors are recommended because of their temperature performance. X7R-type capacitors change capacitance by 15% over their operating temperature range and are the most stable type of ceramic capacitors. Z5U and Y5V dielectric capacitors change value by as much as 50% and 60% respectively over their operating temperature ranges. To use a ceramic chip capacitor with Y5V dielectric, the value must be much higher than an X7R ceramic capacitor to ensure the same minimum capacitance over the equivalent operating temperature range.

### Input Capacitor

An input capacitor of 1.0 $\mu$ F or greater is recommended when the device is more than 4 inches away from the bulk and supply capacitance, or when the supply is a battery. Small, surface-mount chip capacitors can be used for the bypassing. The capacitor should be placed within 1" of the device for optimal performance. Larger values will help to improve ripple rejection by bypassing the input to the regulator, further improving the integrity of the output voltage.

### Transient Response and 3.3V to 2.5V, 2.5V to 1.8V or 1.65V, or 2.5V to 1.5V Conversions

The MIC35152 has excellent transient response to variations in input voltage and load current. The device has been designed to respond quickly to load current variations and input voltage variations. Large output capacitors are not required to obtain this performance. A standard 10 $\mu$ F tantalum capacitor is all that is required. Larger values help to improve performance even further.

By virtue of its low dropout voltage, this device does not saturate into dropout as readily as similar NPN-based designs. When converting from 3.3V to 2.5V, 2.5V to 1.8V or 1.65V, or 2.5V to 1.5V, the NPN-based regulators are already operating in dropout, with typical dropout requirements of 1.2V or greater. To convert down to 2.5V without operating in dropout, NPN-based regulators require an input voltage of 3.7V at the very least. The MIC35152 regulator will provide excellent performance with an input as low as 3.0V or 2.25V, respectively. This gives the PNP-based regulators a distinct advantage over older, NPN-based linear regulators.

### Minimum Load Current

The MIC35152 regulator is specified between finite loads. If the output current is too small, leakage currents load current is necessary for proper operation.

dominate and the output voltage rises. A 10mA minimum

### Enable Input

The MIC35152 also features an enable input for on/off control of the device. Its shutdown state draws "zero" current (only microamperes of leakage). The enable input is TTL/CMOS compatible for simple logic interface, but can be connected to up to  $V_{IN}$ . When enabled, it draws approximately 15 $\mu$ A.

### Adjustable Regulator Design

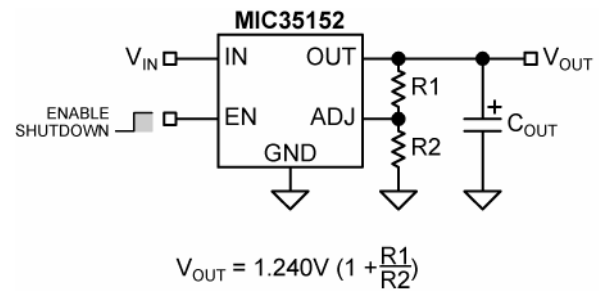

**Figure 1. Adjustable Regulator with Resistors**

The MIC35152 allows programming the output voltage anywhere between 1.24V and the 5.4V. Two resistors are used. The resistor values are calculated by:

$$R1 = R2 \times \left( \frac{V_{OUT}}{1.240} - 1 \right)$$

Where  $V_{OUT}$  is the desired output voltage. Figure 1 shows component definition. Applications with widely varying load currents may scale the resistors to draw the minimum load current required for proper operation (see above).

# Package Information

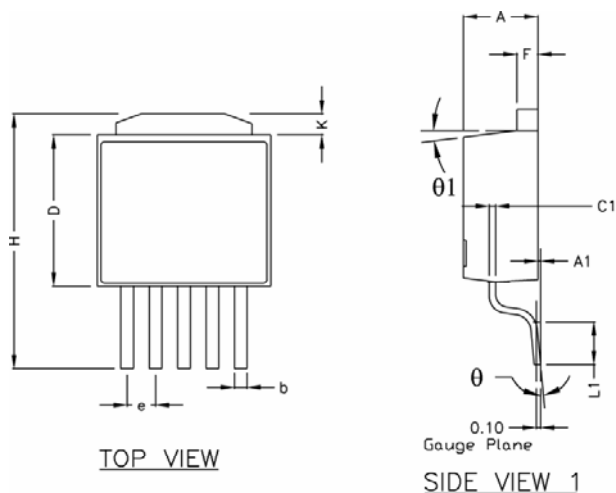

PDS	INCH		MM	
	MIN	MAX	MIN	MAX
A	0.087	0.094	2.210	2.387
A1	0.000	0.012	0.000	0.305
b	0.023	0.026	0.584	0.660
C1	0.012	0.023	0.305	0.584
D	0.236	0.241	6.000	6.200
E	0.252	0.260	6.400	6.604
e	0.045	0.055	1.143	1.397
F	0.019	0.023	0.483	0.584
H	0.378	0.402	9.601	10.210
K	0.039	0.047	1.000	1.200
L1	0.055	0.065	1.397	1.651
theta	0°	8°	0°	8°
theta1	3°	10°	3°	10°
Q	0.055	0.075	1.397	1.905
U	0.206	Ref.	5.232	Ref.
V	0.213	Ref.	5.415	Ref.

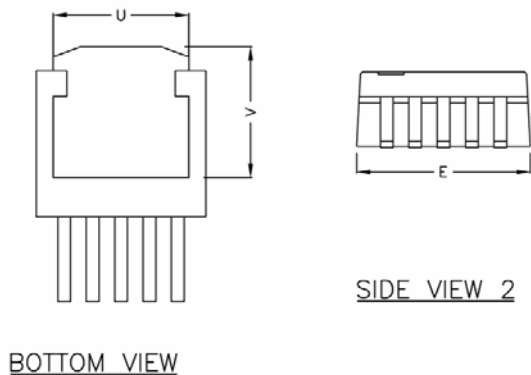

NOTE:  
 1. PACKAGE OUTLINE EXCLUSIVE OF MOLD FLASH & METAL BURR.  
 2. PACKAGE OUTLINE INCLUSIVE OF PLATING THICKNESS.  
 3. FOOT LENGTH USING GAUGE PLANE METHOD MEASUREMENT 0.010"  
 4. ALL DIMENSIONS ARE IN INCHES/MILLIMETERS.

## 5-Pin TO-252 D-PAK (D)

**MICREL, INC. 2180 FORTUNE DRIVE SAN JOSE, CA 95131 USA**  
 TEL +1 (408) 944-0800 FAX +1 (408) 474-1000 WEB <http://www.micrel.com>

The information furnished by Micrel in this data sheet is believed to be accurate and reliable. However, no responsibility is assumed by Micrel for its use. Micrel reserves the right to change circuitry and specifications at any time without notification to the customer.

Micrel Products are not designed or authorized for use as components in life support appliances, devices or systems where malfunction of a product can reasonably be expected to result in personal injury. Life support devices or systems are devices or systems that (a) are intended for surgical implant into the body or (b) support or sustain life, and whose failure to perform can be reasonably expected to result in a significant injury to the user. A Purchaser's use or sale of Micrel Products for use in life support appliances, devices or systems is a Purchaser's own risk and Purchaser agrees to fully indemnify Micrel for any damages resulting from such use or sale.

© 2009 Micrel, Incorporated.