



High Current Density Surface Mount Trench MOS Barrier Schottky Rectifier

Ultra Low $V_F = 0.466$ V at $I_F = 4$ A

TMBS® eSMP™ Series



TO-277A (SMPC)

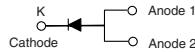

FEATURES

- Very low profile - typical height of 1.1 mm
- Ideal for automated placement
- Trench MOS Schottky Technology
- Low forward voltage drop, low power losses
- High efficiency operation
- Meets MSL level 1, per J-STD-020C, LF max peak of 260 °C
- Component in accordance to RoHS 2002/95/EC and WEEE 2002/96/EC



TYPICAL APPLICATIONS

For use in low voltage high frequency inverters, free-wheeling, dc-to-dc converters and polarity protection applications.

MECHANICAL DATA

Case: TO-277A (SMPC)

Epoxy meets UL 94V-0 flammability rating

Terminals: Matte tin plated leads, solderable per J-STD-002B and JESD22-B102D

E3 suffix for commercial grade, HE3 suffix for high reliability grade (AEC Q101 qualified)

MAJOR RATINGS AND CHARACTERISTICS	
$I_{F(AV)}$	8 A
V_{RRM}	100 V
I_{FSM}	150 A
E_{AS}	100 mJ
V_F at $I_F = 8$ A	0.582 V
T_j max.	150 °C

MAXIMUM RATINGS ($T_A = 25$ °C unless otherwise noted)			
PARAMETER	SYMBOL	V8P10	UNIT
Device marking code		V810	
Maximum repetitive peak reverse voltage	V_{RRM}	100	V
Maximum average forward rectified current (see Fig. 1)	$I_{F(AV)}$	8	A
Peak forward surge current 10 ms single half sine-wave superimposed on rated load	I_{FSM}	150	A
Non-repetitive avalanche energy at $I_{AS} = 2.0$ A, $L = 50$ mH, $T_j = 25$ °C	E_{AS}	100	mJ
Voltage rate of change (rated V_R)	dv/dt	10000	V/ μ s
Operating junction and storage temperature range	T_J, T_{STG}	- 40 to + 150	°C



V8P10

Vishay General Semiconductor

ELECTRICAL CHARACTERISTICS ($T_A = 25\text{ }^\circ\text{C}$ unless otherwise noted)					
PARAMETER	TEST CONDITIONS	SYMBOL	TYP	MAX.	UNIT
Breakdown voltage	at $I_R = 1.0\text{ mA}$ $T_j = 25\text{ }^\circ\text{C}$	$V_{(BR)}$	100 (minimum)	-	V
Instantaneous forward voltage ⁽¹⁾	at $I_F = 4\text{ A}$ $T_j = 25\text{ }^\circ\text{C}$	V_F	0.522	-	V
	at $I_F = 8\text{ A}$ $T_j = 25\text{ }^\circ\text{C}$		0.643	0.68	
Reverse current ⁽¹⁾	at $V_R = 70\text{ V}$ $T_j = 25\text{ }^\circ\text{C}$	I_R	4.7	-	μA
	at $V_R = 70\text{ V}$ $T_j = 125\text{ }^\circ\text{C}$		3.0	-	mA
	at $V_R = 100\text{ V}$ $T_j = 25\text{ }^\circ\text{C}$		14.5	70	μA
	at $V_R = 100\text{ V}$ $T_j = 125\text{ }^\circ\text{C}$		7.0	15	mA

Note:

(1) Pulse test: 300 μs pulse width, 1 % duty cycle

THERMAL CHARACTERISTICS ($T_A = 25\text{ }^\circ\text{C}$ unless otherwise noted)			
PARAMETER	SYMBOL	V8P10	UNIT
Typical thermal resistance	$R_{\theta JA}$ ⁽¹⁾ $R_{\theta JL}$	60 3	$^\circ\text{C/W}$

Note:

(1) Units mounted on recommended P.C.B. 1 oz. pad layout

ORDERING INFORMATION (Example)				
PREFERRED P/N	UNIT WEIGHT (g)	PREFERRED PACKAGE CODE	BASE QUANTITY	DELIVERY MODE
V8P10-E3/86A	0.10	86A	1500	7" Diameter Plastic Tape & Reel
V8P10-E3/87A	0.10	87A	6500	13" Diameter Plastic Tape & Reel
V8P10HE3/86A ⁽¹⁾	0.10	86A	1500	7" Diameter Plastic Tape & Reel
V8P10HE3/87A ⁽¹⁾	0.10	87A	6500	13" Diameter Plastic Tape & Reel

Note:

(1) Automotive grade AEC Q101 qualified

RATINGS AND CHARACTERISTICS CURVES

($T_A = 25\text{ }^\circ\text{C}$ unless otherwise noted)

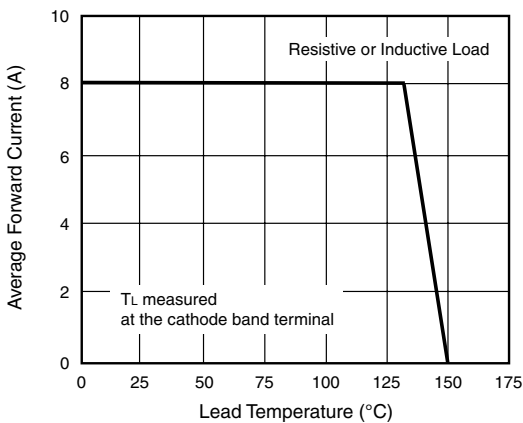

Figure 1. Maximum Forward Current Derating Curve

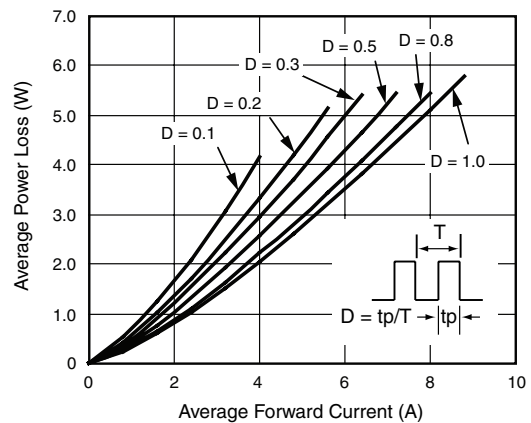

Figure 2. Forward Power Loss Characteristics

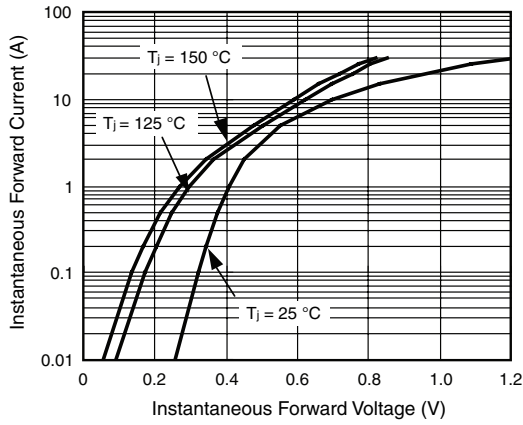

Figure 3. Typical Instantaneous Forward Characteristics

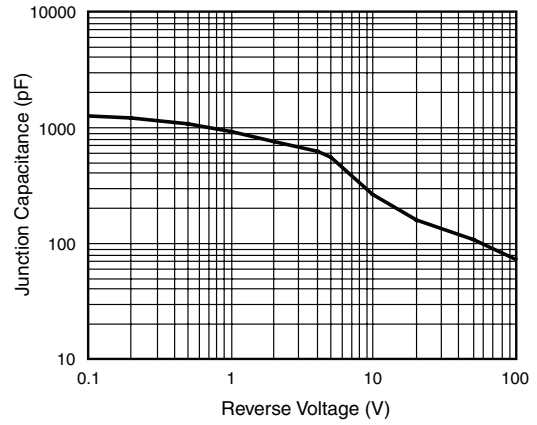

Figure 5. Typical Junction Capacitance

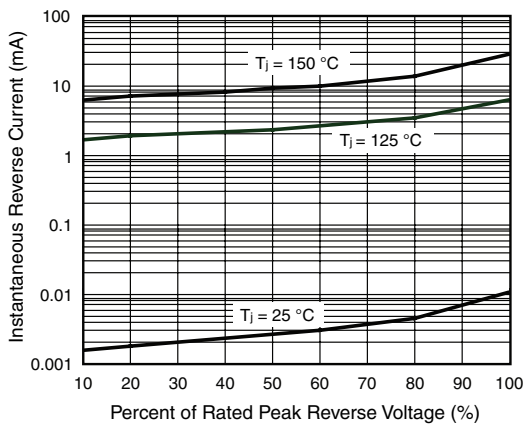

Figure 4. Typical Reverse Characteristics

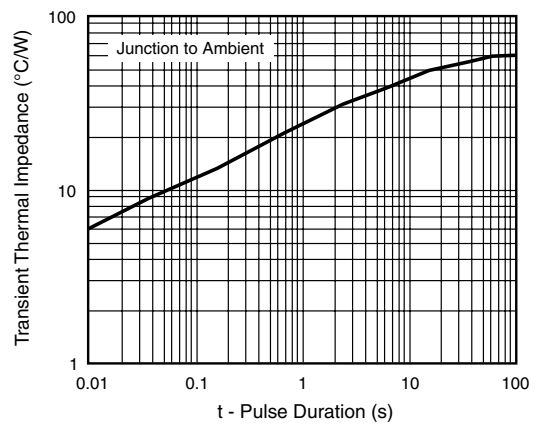

Figure 6. Typical Transient Thermal Impedance



V8P10

Vishay General Semiconductor

PACKAGE OUTLINE DIMENSIONS in inches (millimeters)

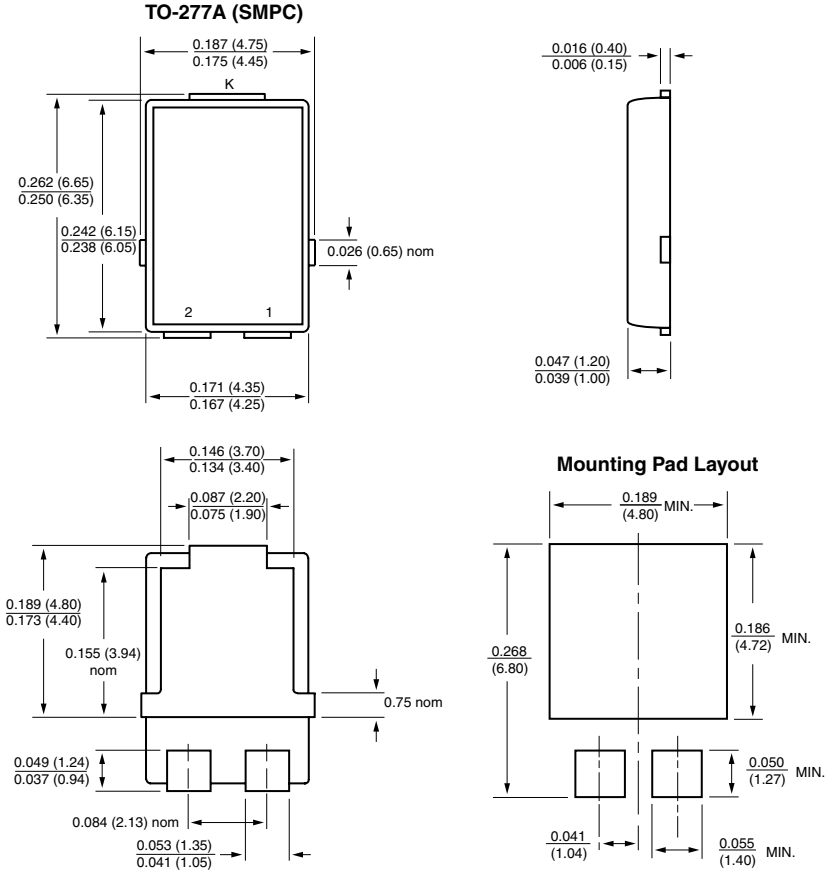

Conform to JEDEC TO-277A



Notice

Specifications of the products displayed herein are subject to change without notice. Vishay Intertechnology, Inc., or anyone on its behalf, assumes no responsibility or liability for any errors or inaccuracies.

Information contained herein is intended to provide a product description only. No license, express or implied, by estoppel or otherwise, to any intellectual property rights is granted by this document. Except as provided in Vishay's terms and conditions of sale for such products, Vishay assumes no liability whatsoever, and disclaims any express or implied warranty, relating to sale and/or use of Vishay products including liability or warranties relating to fitness for a particular purpose, merchantability, or infringement of any patent, copyright, or other intellectual property right.

The products shown herein are not designed for use in medical, life-saving, or life-sustaining applications. Customers using or selling these products for use in such applications do so at their own risk and agree to fully indemnify Vishay for any damages resulting from such improper use or sale.