

New Electro-Optical Design 13mm (1/2 Inch) Diameter, 9-stage, Side-on Type

Our new electro-optic construction allows Hamamatsu to introduce an improved line of compact side-on PMTs. The X-axis anode uniformity full width half maximum (FWHM) is greater than existing models. This wider "sweet" spot increases detection efficiency and can make optical alignment easier.

The R6357 is a unique addition, it is the new meshless multialkali compact PMT having over 100mA/W photocathode radiant sensitivity.



▲ Left: Quartz window Center: UV window
Right: Meshless type (R6357)

APPLICATIONS

- Emission Spectroscopy (ICP, Direct Reader)
- Environmental Monitoring (NO_x, SO₂, etc.)
- Fluorescence Immunoassay
- Chemiluminescence Immunoassay
- Hygiene Monitor (Bio Luminescence)
- X-ray Phototimer
- Fluorometer
- Microscope (Laser Scanning Microscope)

NEW COMPACT TYPE PMT SERIES

Side-On New Compact Type Photomultiplier Tubes

Type No.	Remarks	Spectral Response		Photo-cathode Material	Window Material	Outline No.	Dynode Structure	Socket	Maximum Ratings		Cathode Sensitivity	
		Range (nm)	Peak Wavelength (nm)						Anode to Cathode Voltage (Vdc)	Average Anode Current (mA)	Luminous	
				Min. (μA/lm)	Typ. (μA/lm)							
R6350	For UV to visible range, general purpose.	185 to 650	340	Sb-Cs	U	1	CC/9	E678-11U/ⓔ	1250	0.01	20	40
R6351	Synthetic silica window type of R6350	160 to 650	340	Sb-Cs	Q	2	CC/9	E678-11U/ⓔ	1250	0.01	20	40
R6352	High sensitivity variant of R6350	185 to 750	420	BA	U	1	CC/9	E678-11U/ⓔ	1250	0.01	80	120
R6353	Low dark current bialkali photocathode	185 to 680	400	LBA	U	1	CC/9	E678-11U/ⓔ	1250	0.01	30	70
R6354	For UV range	160 to 320	230	Cs-Te	Q	2	CC/9	E678-11U/ⓔ	1250	0.01	—	—
R6355	For UV to near IR range, general purpose	185 to 850	530	MA	U	1	CC/9	E678-11U/ⓔ	1250	0.01	80	150
R6356	High sensitivity variant of R6355	185 to 900	600	MA	U	1	CC/9	E678-11U/ⓔ	1250	0.01	140	250
R6357 *	High sensitivity variant of R6356, Meshless type	185 to 900	450	MA	U	1	CC/9	E678-11U/ⓔ	1250	0.01	350	500
R6358	Low dark current variant of R6356	185 to 830	530	LMA	U	1	CC/9	E678-11U/ⓔ	1250	0.01	140	200

* Achieved the higher photocathode sensitivity by eliminating the mesh in front of the photocathode. It also features no output variation, disturbed by the mesh, when the incident light spot to the photocathode is small.

NOTE Ⓐ Photocathode materials

- BA: Bialkali
- LBA: Low dark current bialkali
- MA: Multialkali
- LMA: Low dark current multialkali

Ⓑ Window materials

- Q: Synthetic silica
- U: UV glass

Ⓒ Outline No.

See Fig. 9

Ⓓ Dynode structure

- CC: Circular-cage

ⓔ See optional accessories

ⓕ The maximum ambient temperature range is -80 to +50°C.

ⓖ Averaged over any interval of 30 seconds maximum.

Figure 1: Typical Spectral Response of Cs-Te

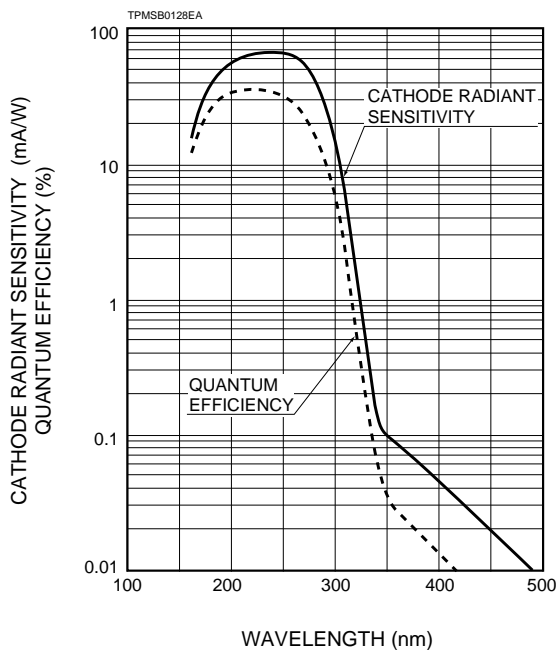
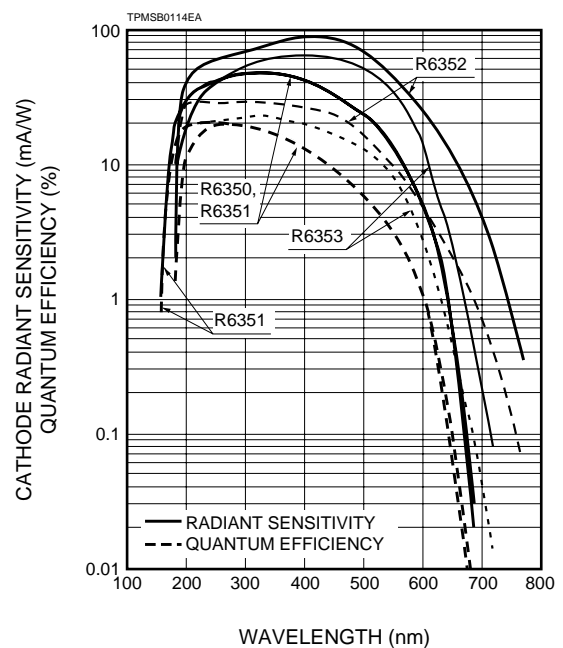

Figure 2: Typical Spectral Response of BA, LBA, Sb-Cs



Cathode Sensitivity			Anode Characteristics									Notes	Type No.
Blue (5-58) Typ. ($\mu\text{A/lm-b}$)	Red/White Ratio Typ.	Radiant Typ. (mA/W)	Anode to Cathode Supply Voltage (Vdc)	Anode Sensitivity			Current Amplification Typ.	Anode Dark Current (After 30 min.)		Time Response			
				Luminous		Radiant Typ. (nm)		Typ.	Max.	Rise Time Typ. (ns)	Electron Transit Time Typ. (ns)		
				Min. (A/lm)	Typ. (A/lm)								
5	—	48	1000	50	300	3.6×10^5	7.5×10^6	0.5	5	1.4	15	Photon counting type: R6350P: 10cps Typ.	R6350
5	—	48	1000	50	300	3.6×10^5	7.5×10^6	0.5	5	1.4	15		R6351
10	—	90	1000	100	700	5.2×10^5	5.8×10^6	1	10	1.4	15		R6352
6.5	—	65	1000	100	400	3.7×10^5	5.7×10^6	0.1	2	1.4	15	Photon counting type: R6353P: 10cps Typ.	R6353
—	—	62 ^a	1000	—	—	1.8×10^5 ^a	3×10^6	0.5	5	1.4	15		R6354
6	0.15	45	1000	100	600	1.8×10^5	4×10^6	1	10	1.4	15		R6355
7	0.3	60	1000	400	2500	6×10^5	1×10^7	1	10	1.4	15		R6356
13	0.4	105	1000	1000	2000	4.2×10^5	4×10^6	2	10	1.4	15		R6357 *
7.5	0.15	70	1000	300	700	2.5×10^5	3.5×10^6	0.1	1	1.4	15	Photon counting type: R6358P: 20cps Typ.	R6358

^H Measured using red filter Toshiba R-68.

^I Measured at the peak wavelength.

^J Refer to Note ^L.

^a : at 254nm

^K Anode characteristics are measured with the supply voltage and voltage distribution ratio specified by Note ^L.

^L Voltage distribution ratio and voltage.

Electrodes	K	Dy1	Dy2	Dy3	Dy4	Dy5	Dy6	Dy7	Dy8	Dy9	P
Distribution Ratio	1	1	1	1	1	1	1	1	1	1	1

Supply Voltage: 1000Vdc, K: Cathode, Dy: Dynode, P: Anode

Figure 3: Typical Spectral Response of MA, LMA

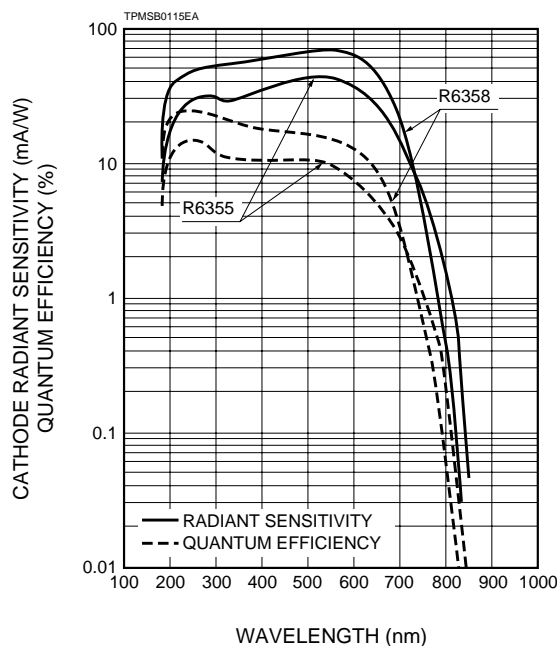

Figure 4: Typical Spectral Response of High Sensitivity MA

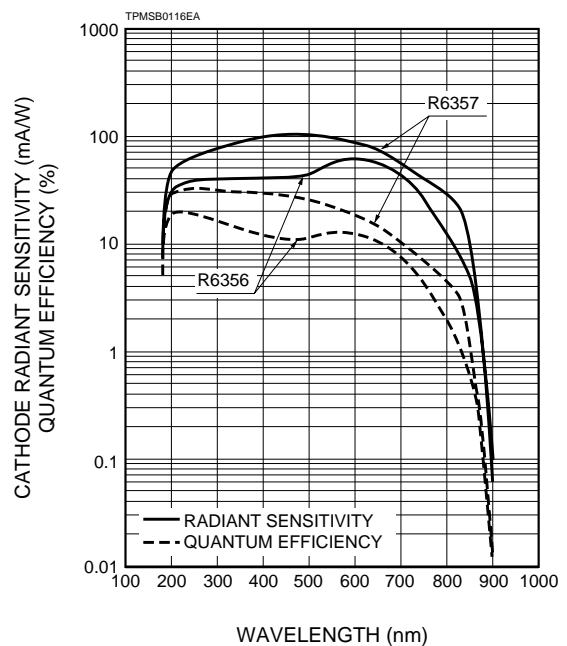

Figure 5: Typical Current Amplification

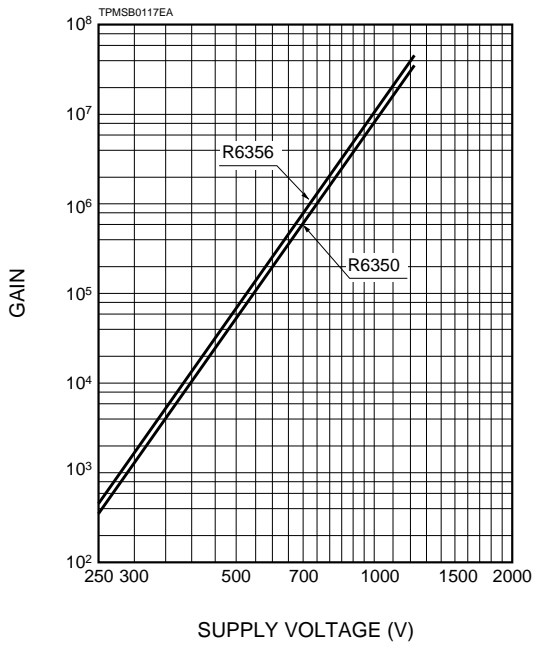

Figure 6: Typical Time Response

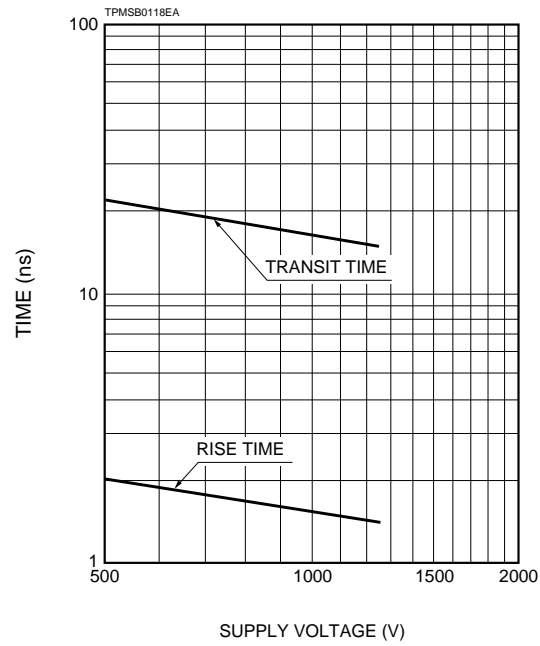

Figure 7: Typical ENI Characteristics

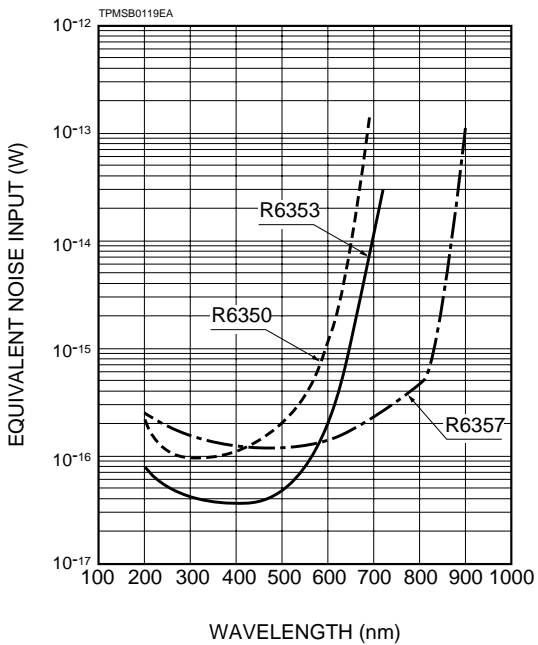

Figure 8: Typical Anode Uniformity

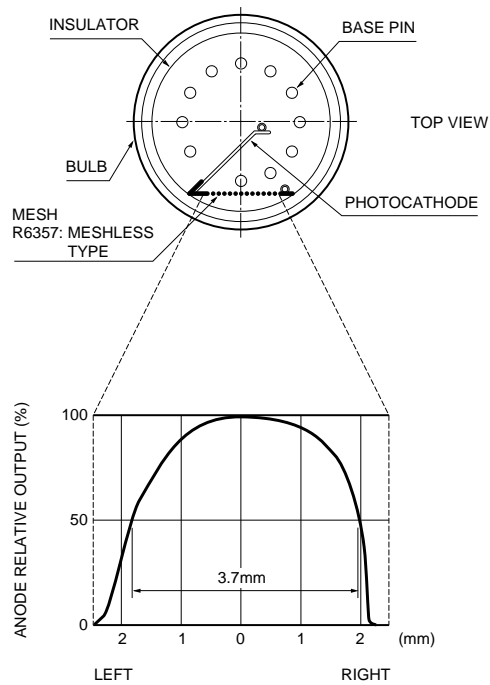
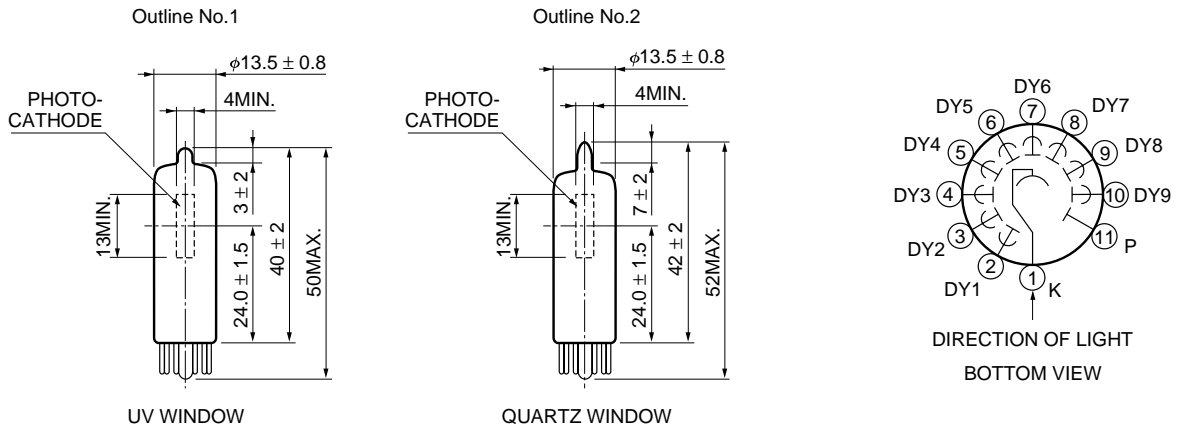

Figure 9: Dimensional Outline and Basing Diagram (Unit: mm)



TPMSA0034EB

Socket

E678-11U

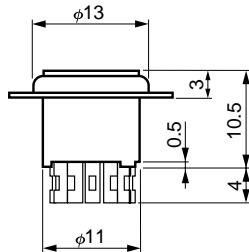
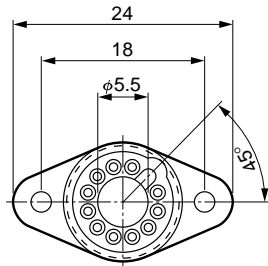

TACCA0181EA

E678-11T (Option):
For direct soldering to PC board

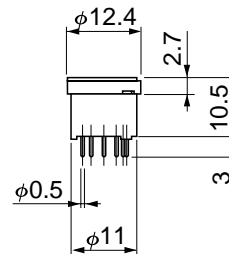
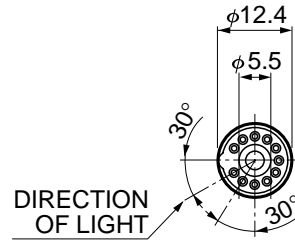

TACCA0161EA

Remaining Hamamatsu Photonics 1/2" side on PMT anode cap types and compact types will be discontinued by the year 2000.

We recommend the new compact types instead of those current in use.

■ Correlation among anode cap type, current compact type and new compact type

TYPE/GRADE	ANODE CAP TYPE	CURRENT COMPACT TYPE	NEW COMPACT TYPE
Sb-Cs/UV	R300/R444	R1414/R1413	R6350
Sb-Cs/Q	R306	R1656	R6351
BA/UV HIGH	—	R5785	R6352
LBA/UV	—	R2371	R6353
MA/UV	R889	R1547/R1546	R6355
MA/UV HIGH	—	R3823	R6356
MA/UV HIGH	—	R3823-03	R6357
LMA/UV	—	R4457	R6358
Cs-Te/Q	R427	R1657	R6354

NOTE UV: UV WINDOW, Q: QUARTZ WINDOW, HIGH: HIGH SENSITIVITY

