

## NEC's NPN SiGe HIGH FREQUENCY TRANSISTOR

### FEATURES

- **HIGH BREAKDOWN VOLTAGE SiGe TECHNOLOGY**  
V<sub>CEO</sub> = 5 V (Absolute Maximum)
- **LOW NOISE FIGURE:**  
NF = 0.8 dBm at 2 GHz  
NF = 1.3 dBm at 5.2 GHz
- **HIGH MAXIMUM STABLE GAIN:**  
MSG = 21.5 dB at 2 GHz
- **LOW PROFILE M05 PACKAGE:**  
SOT-343 footprint, with a height of only 0.59 mm  
Flat lead style for better RF performance
- **Pb Free Available (-A)**

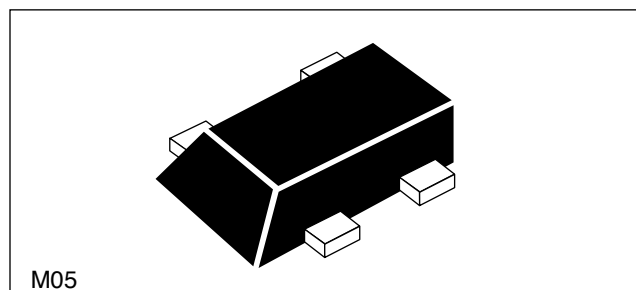

### DESCRIPTION

NEC's NESG2031M05 is fabricated using NEC's high voltage Silicon Germanium process (UHS2-HV), and is designed for a wide range of applications including low noise amplifiers, medium power amplifiers, and oscillators.

NEC's low profile, flat lead style M05 Package provides high frequency performance for compact wireless designs.

### ELECTRICAL CHARACTERISTICS (T<sub>A</sub> = 25°C)

PART NUMBER PACKAGE OUTLINE		NESG2031M05 M05				
SYMBOLS	PARAMETERS AND CONDITIONS	UNITS	MIN	TYP	MAX	
RF	NF	Noise Figure at V <sub>CE</sub> = 2 V, I <sub>C</sub> = 5 mA, f = 5.2 GHz, Z <sub>S</sub> = Z <sub>SOPT</sub> , Z <sub>L</sub> = Z <sub>LOPT</sub>	dB		1.3	
	G <sub>a</sub>	Associated Gain at V <sub>CE</sub> = 2 V, I <sub>C</sub> = 5 mA, f = 5.2 GHz, Z <sub>S</sub> = Z <sub>SOPT</sub> , Z <sub>L</sub> = Z <sub>LOPT</sub>	dB		10.0	
	NF	Noise Figure at V <sub>CE</sub> = 2 V, I <sub>C</sub> = 5 mA, f = 2 GHz, Z <sub>S</sub> = Z <sub>SOPT</sub> , Z <sub>L</sub> = Z <sub>LOPT</sub>	dB		0.8	1.1
	G <sub>a</sub>	Associated Gain at V <sub>CE</sub> = 2 V, I <sub>C</sub> = 5 mA, f = 2 GHz, Z <sub>S</sub> = Z <sub>SOPT</sub> , Z <sub>L</sub> = Z <sub>LOPT</sub>	dB	15.0	17.0	
	MSG	Maximum Stable Gain <sup>1</sup> at V <sub>CE</sub> = 3 V, I <sub>C</sub> = 20 mA, f = 2 GHz	dB	19.0	21.5	
	IS <sub>21E</sub> I <sup>2</sup>	Insertion Power Gain at V <sub>CE</sub> = 3 V, I <sub>C</sub> = 20 mA, f = 2 GHz	dB	16.0	18.0	
	P <sub>1dB</sub>	Output Power at 1dB Compression Point at V <sub>CE</sub> = 3 V, I <sub>C</sub> = 20 mA, f = 2 GHz	dBm		13	
	OIP <sub>3</sub>	Output 3rd Order Intercept Point at V <sub>CE</sub> = 3 V, I <sub>C</sub> = 20 mA, f = 2 GHz	dBm		23	
	f <sub>T</sub>	Gain Bandwidth Product at V <sub>CE</sub> = 3 V, I <sub>C</sub> = 20 mA, f = 2 GHz	GHz	20	25	
C <sub>re</sub>	Reverse Transfer Capacitance <sup>2</sup> at V <sub>CB</sub> = 2 V, I <sub>C</sub> = 0 mA, f = 1 GHz	pF		0.15	0.25	
DC	I <sub>CBO</sub>	Collector Cutoff Current at V <sub>CB</sub> = 5V, I <sub>E</sub> = 0	nA			100
	I <sub>EBO</sub>	Emitter Cutoff Current at V <sub>EB</sub> = 1 V, I <sub>C</sub> = 0	nA			100
	h <sub>FE</sub>	DC Current Gain <sup>3</sup> at V <sub>CE</sub> = 2 V, I <sub>C</sub> = 5 mA		130	190	260

Notes:

1.  $MSG = \left| \frac{S_{21}}{S_{12}} \right|$

2. Collector to base capacitance is measured by capacitance meter (automatic balance bridge method) when emitter pin is connected to the guard pin.

3. Pulsed measurement, pulse width ≤ 350 μs, duty cycle ≤ 2 %.

The information in this document is subject to change without notice. Before using this document, please confirm that this is the latest version.

**ABSOLUTE MAXIMUM RATINGS<sup>1</sup>** (T<sub>A</sub> = 25°C)

SYMBOLS	PARAMETERS	UNITS	RATINGS
V <sub>CB0</sub>	Collector to Base Voltage	V	13.0
V <sub>CEO</sub>	Collector to Emitter Voltage	V	5.0
V <sub>EBO</sub>	Emitter to Base Voltage	V	1.5
I <sub>C</sub>	Collector Current	mA	35
P <sub>T</sub> <sup>2</sup>	Total Power Dissipation	mW	175
T <sub>J</sub>	Junction Temperature	°C	150
T <sub>STG</sub>	Storage Temperature	°C	-65 to +150

Note:

1. Operation in excess of any one of these parameters may result in permanent damage.
2. Mounted on 1.08 cm<sup>2</sup> x 1.0 mm (t) glass epoxy PCB.

**THERMAL RESISTANCE**

SYMBOLS	PARAMETERS	UNITS	RATINGS
R <sub>th j-c</sub>	Junction to Case Resistance	°C/W	TBD

**ORDERING INFORMATION**

PART NUMBER	QUANTITY	SUPPLY FORM
NESG2031M05-T1	3 kpcs/reel	<ul style="list-style-type: none"> <li>• Pin 3 (Collector), Pin 4 (Emitter) face the perforation</li> <li>• 8 mm wide embossed taping</li> </ul>
NESG2031M05-T1-A	3 kpcs/reel	<ul style="list-style-type: none"> <li>• Pb Free</li> <li>• Pin 3 (Collector), Pin 4 (Emitter) face the perforation</li> <li>• 8 mm wide embossed taping</li> </ul>

**TYPICAL PERFORMANCE CURVES** (T<sub>A</sub> = 25°C)

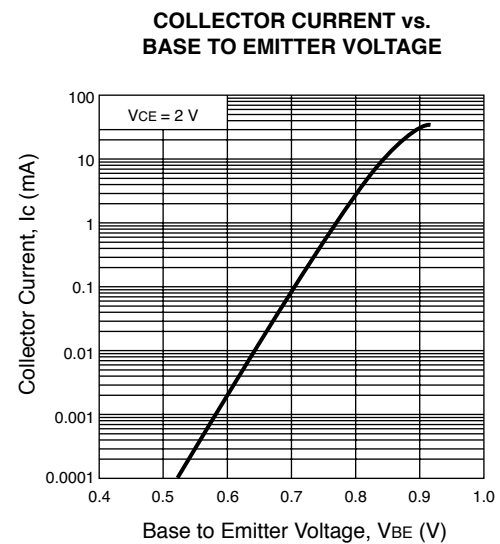
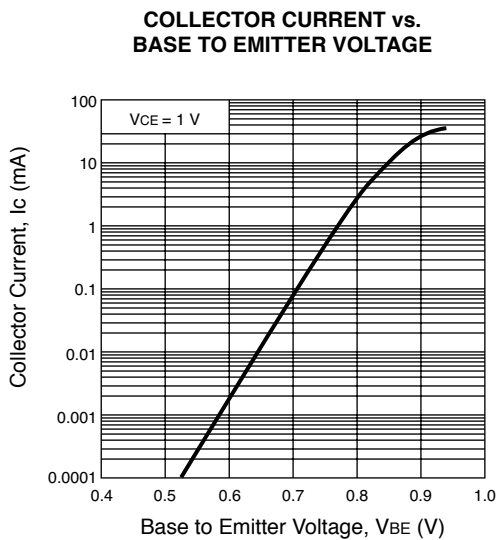
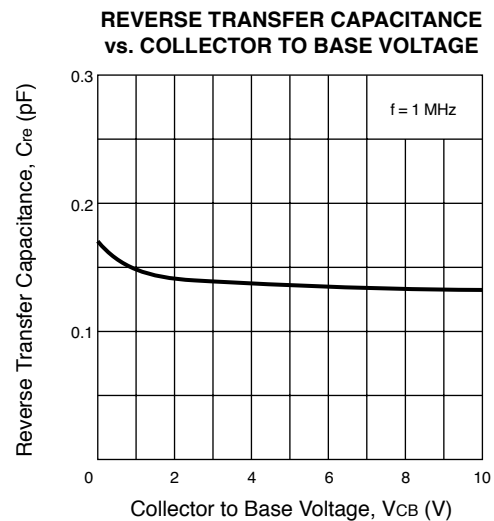
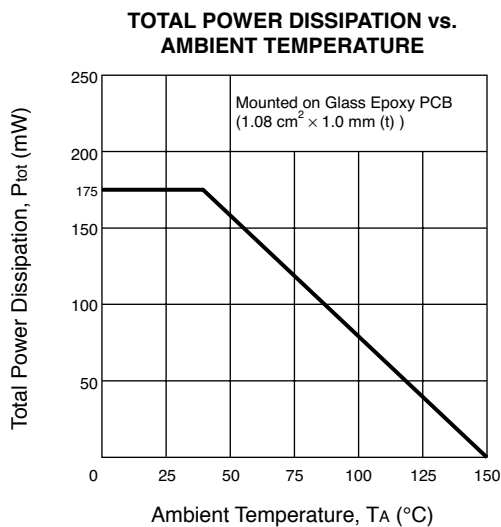

TYPICAL PERFORMANCE CURVES (T<sub>A</sub>= 25°C)

COLLECTOR CURRENT vs. BASE TO EMITTER VOLTAGE

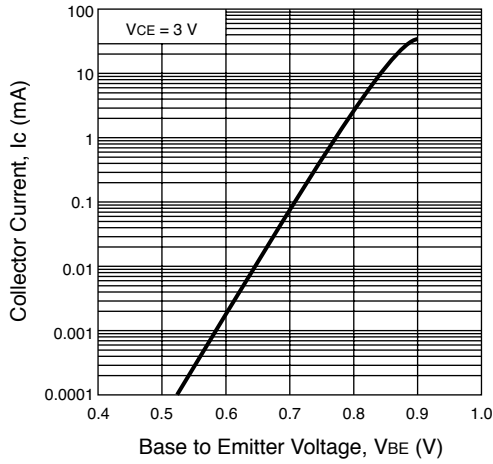

COLLECTOR CURRENT vs. COLLECTOR TO EMITTER VOLTAGE

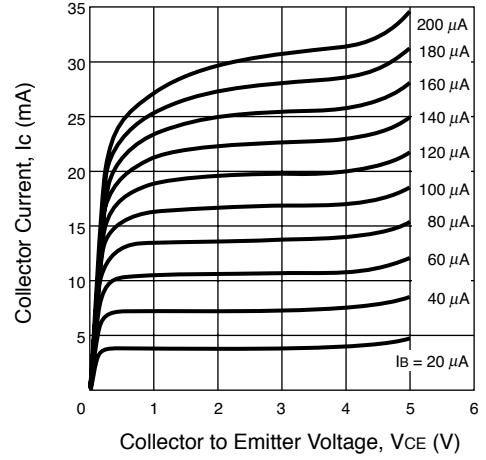

DC CURRENT GAIN vs. COLLECTOR CURRENT

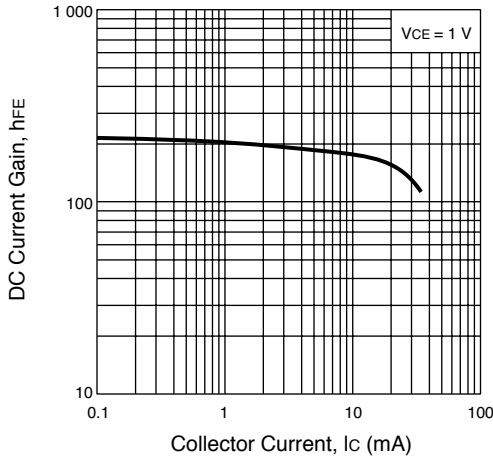

DC CURRENT GAIN vs. COLLECTOR CURRENT

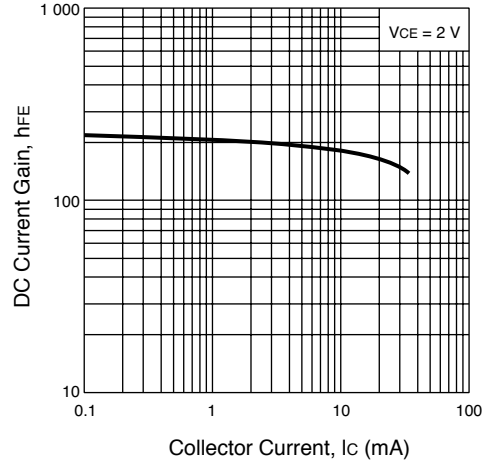

DC CURRENT GAIN vs. COLLECTOR CURRENT

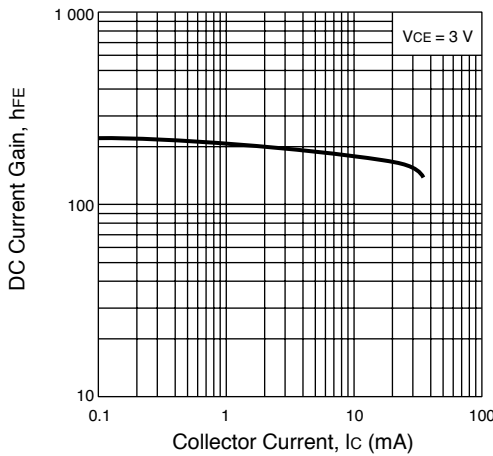

GAIN BANDWIDTH PRODUCT vs. COLLECTOR CURRENT

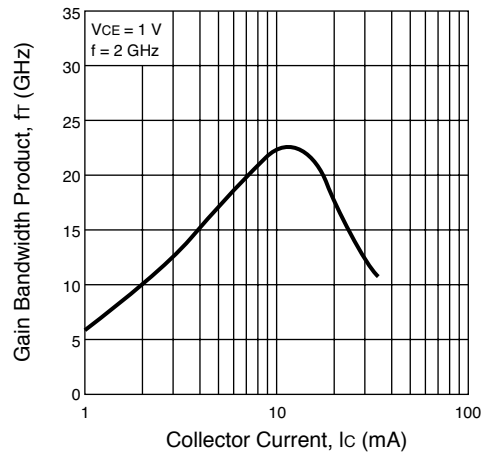

TYPICAL PERFORMANCE CURVES (T<sub>A</sub>= 25°C)

**GAIN BANDWIDTH PRODUCT vs. COLLECTOR CURRENT**

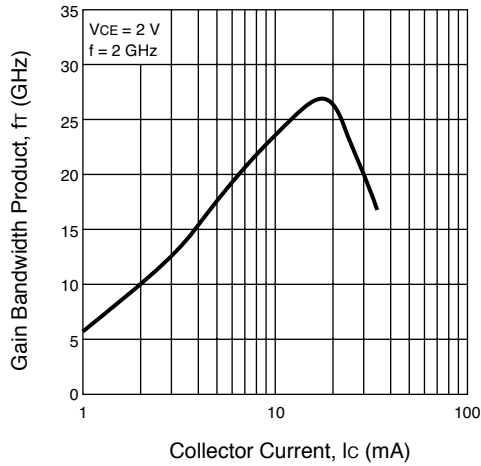

**GAIN BANDWIDTH PRODUCT vs. COLLECTOR CURRENT**

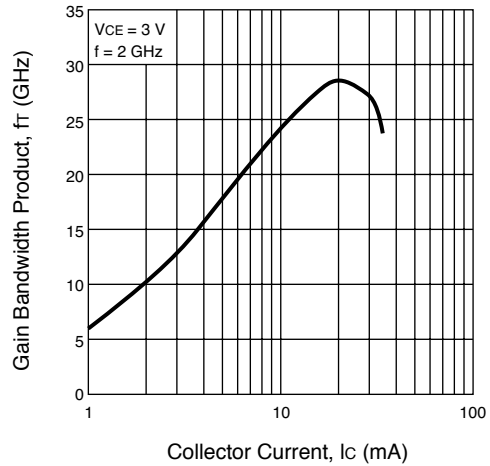

**INSERTION POWER GAIN, MAG, MSG vs. FREQUENCY**

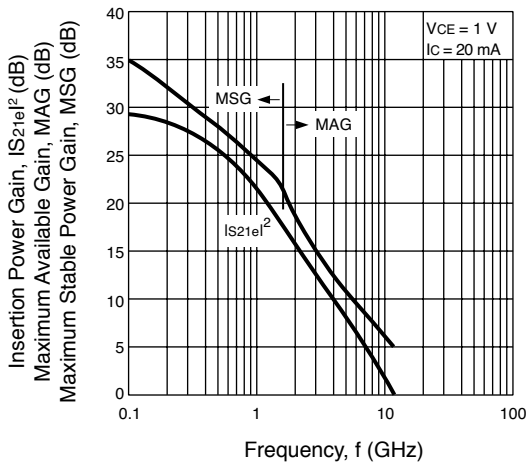

**INSERTION POWER GAIN, MAG, MSG vs. FREQUENCY**

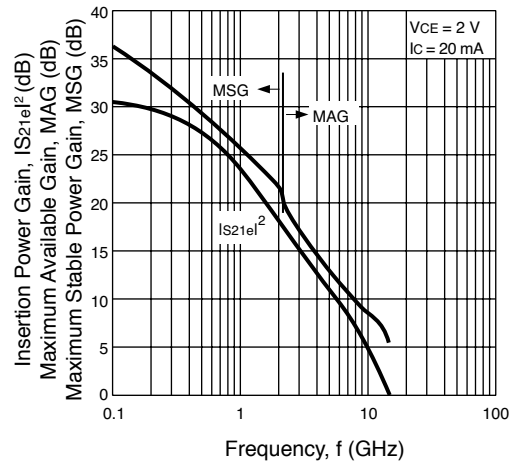

**INSERTION POWER GAIN, MAG, MSG vs. FREQUENCY**

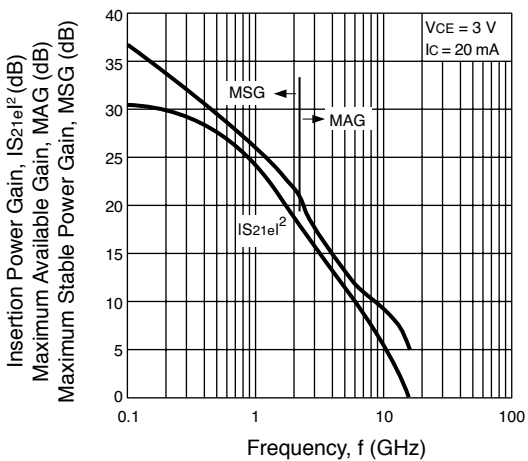

**INSERTION POWER GAIN, MAG, MSG vs. COLLECTOR CURRENT**

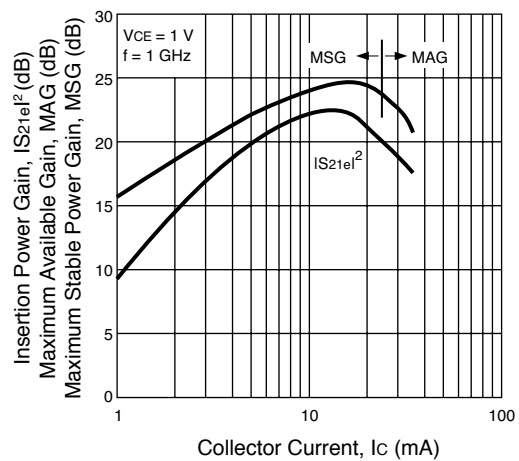

TYPICAL PERFORMANCE CURVES (TA= 25°C)

INSERTION POWER GAIN, MAG, MSG vs. COLLECTOR CURRENT

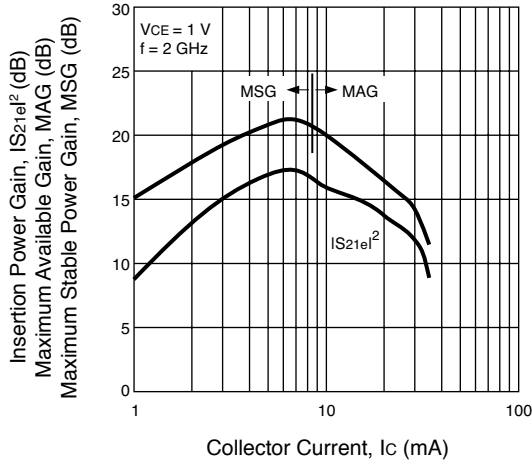

INSERTION POWER GAIN, MAG, MSG vs. COLLECTOR CURRENT

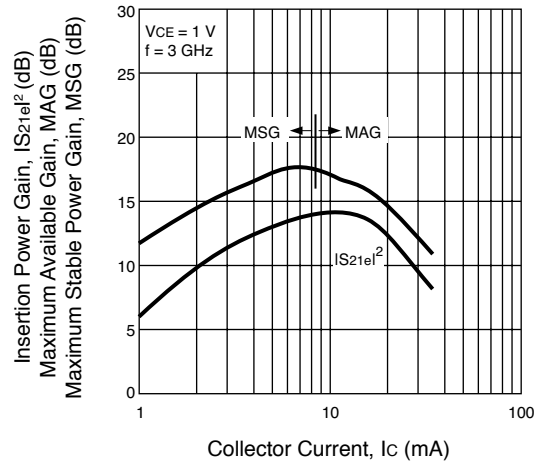

INSERTION POWER GAIN, MAG, MSG vs. COLLECTOR CURRENT

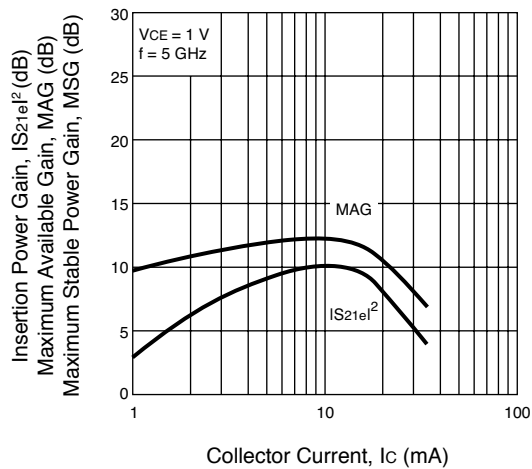

INSERTION POWER GAIN, MAG, MSG vs. COLLECTOR CURRENT

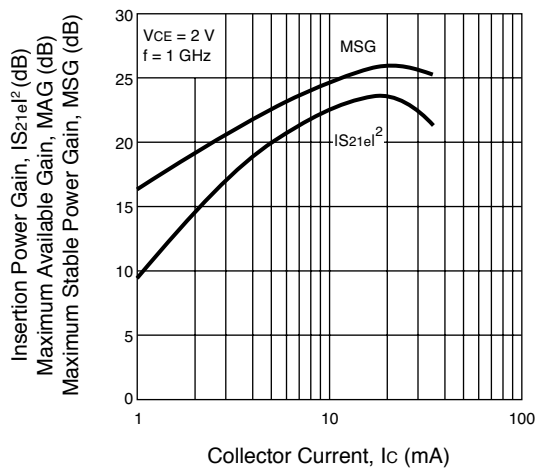

INSERTION POWER GAIN, MAG, MSG vs. COLLECTOR CURRENT

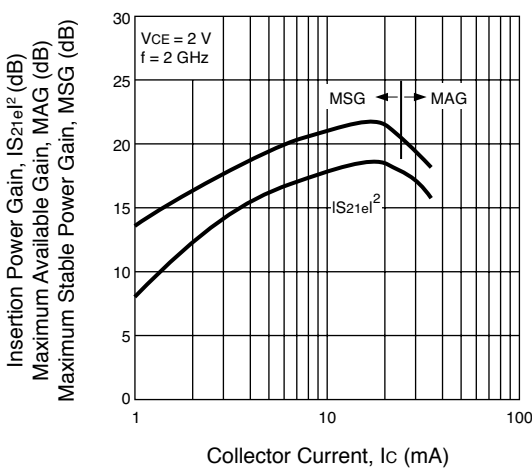

INSERTION POWER GAIN, MAG, MSG vs. COLLECTOR CURRENT

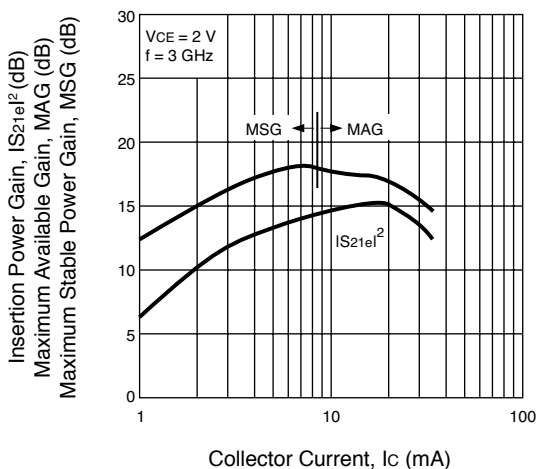

TYPICAL PERFORMANCE CURVES (T<sub>A</sub>= 25°C)

INSERTION POWER GAIN, MAG, MSG vs. COLLECTOR CURRENT

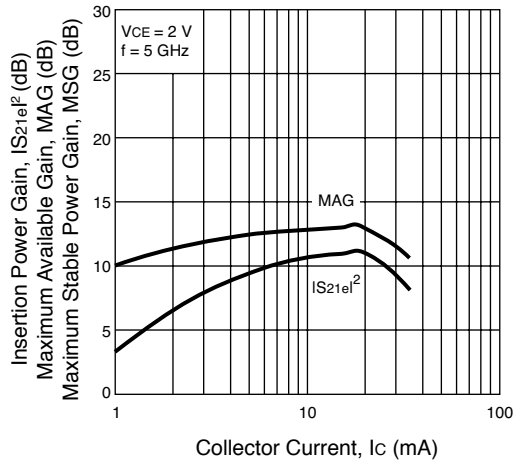

INSERTION POWER GAIN, MAG, MSG vs. COLLECTOR CURRENT

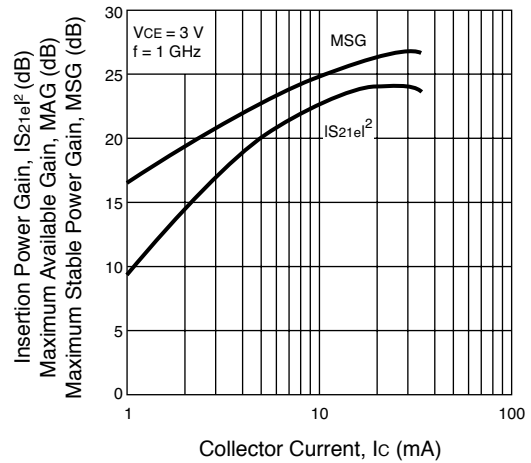

INSERTION POWER GAIN, MAG, MSG vs. COLLECTOR CURRENT

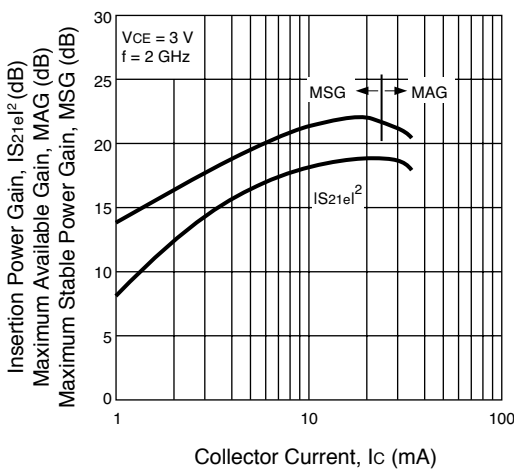

INSERTION POWER GAIN, MAG, MSG vs. COLLECTOR CURRENT

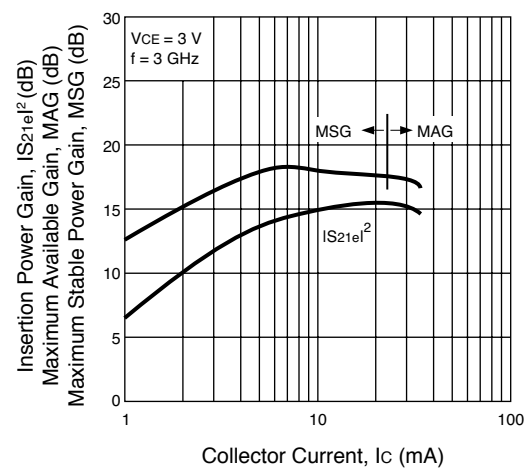

INSERTION POWER GAIN, MAG, MSG vs. COLLECTOR CURRENT

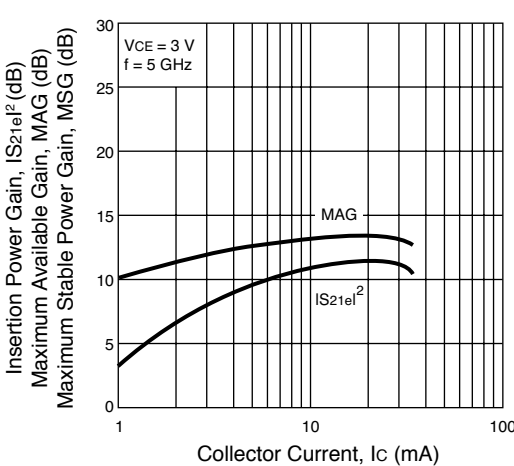

OUTPUT POWER, COLLECTOR CURRENT vs. INPUT POWER

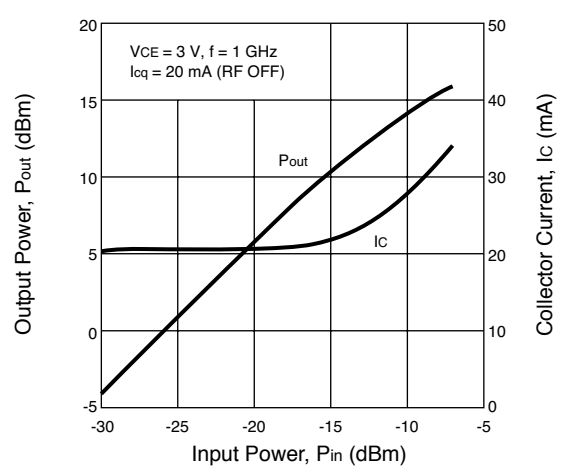

TYPICAL PERFORMANCE CURVES (T<sub>A</sub>= 25°C)

OUTPUT POWER, COLLECTOR CURRENT vs. INPUT POWER

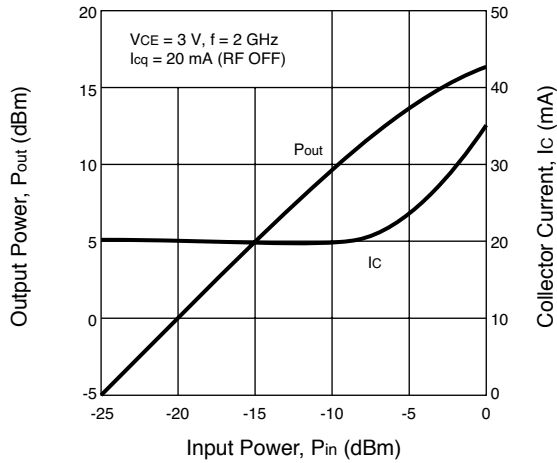

OUTPUT POWER, COLLECTOR CURRENT vs. INPUT POWER

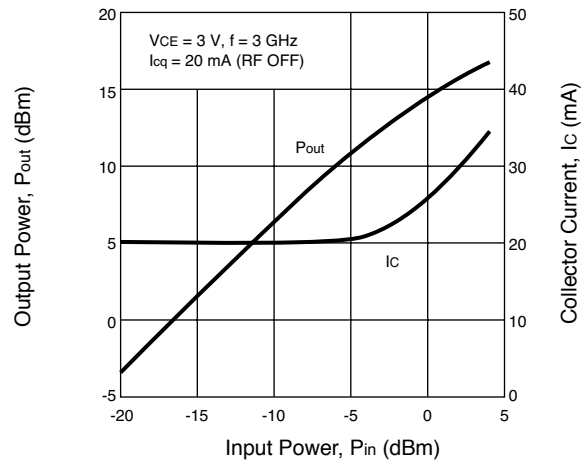

OUTPUT POWER, COLLECTOR CURRENT vs. INPUT POWER

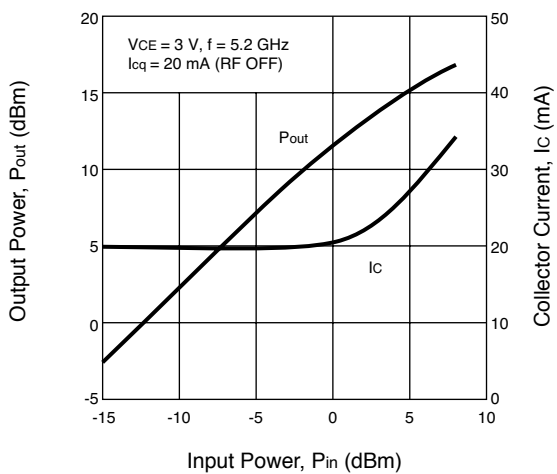

NOISE FIGURE, ASSOCIATED GAIN vs. COLLECTOR CURRENT

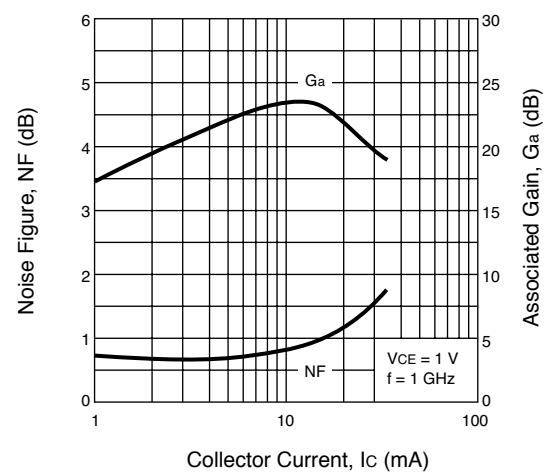

NOISE FIGURE, ASSOCIATED GAIN vs. COLLECTOR CURRENT

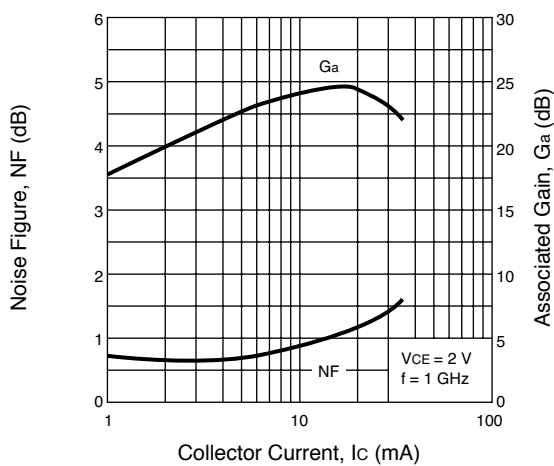

NOISE FIGURE, ASSOCIATED GAIN vs. COLLECTOR CURRENT

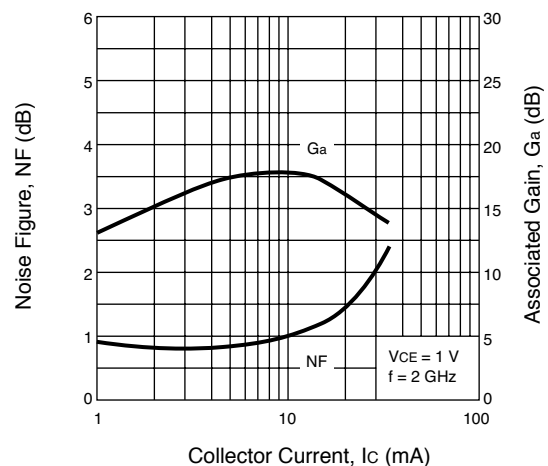

TYPICAL PERFORMANCE CURVES (T<sub>A</sub>= 25°C)

NOISE FIGURE, ASSOCIATED GAIN vs. COLLECTOR CURRENT

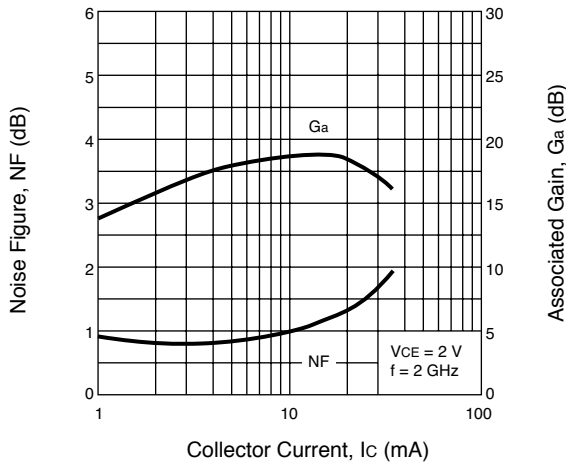

NOISE FIGURE, ASSOCIATED GAIN vs. COLLECTOR CURRENT

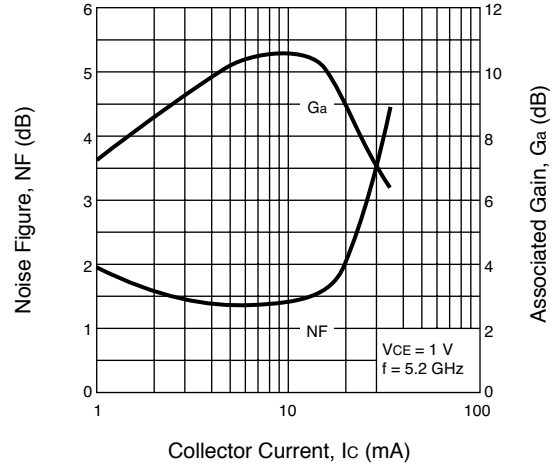

NOISE FIGURE, ASSOCIATED GAIN vs. COLLECTOR CURRENT

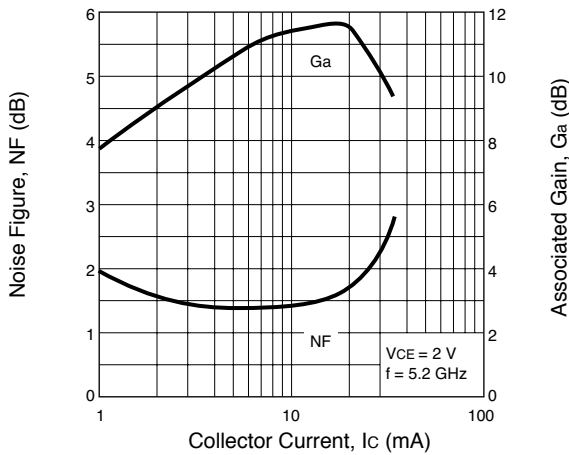

NOISE FIGURE, ASSOCIATED GAIN vs. COLLECTOR CURRENT

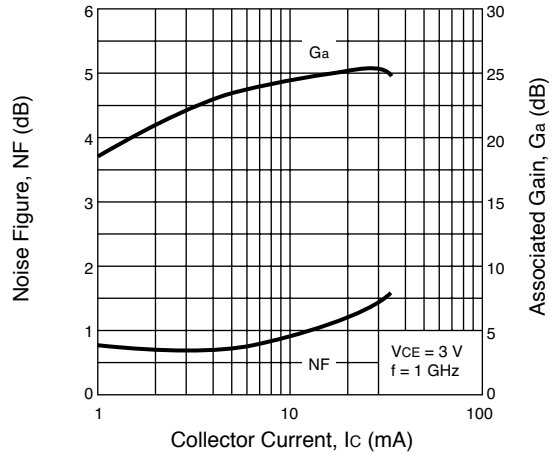

NOISE FIGURE, ASSOCIATED GAIN vs. COLLECTOR CURRENT

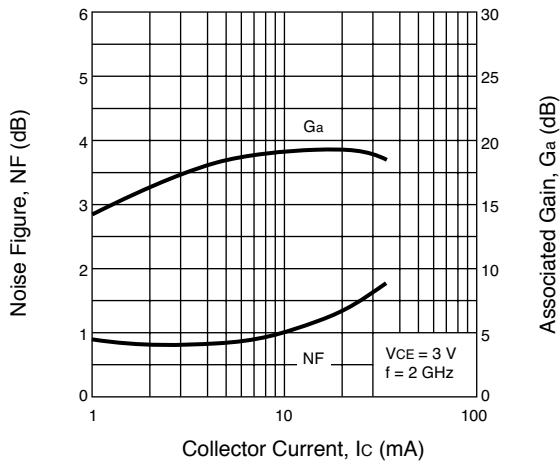

NOISE FIGURE, ASSOCIATED GAIN vs. COLLECTOR CURRENT

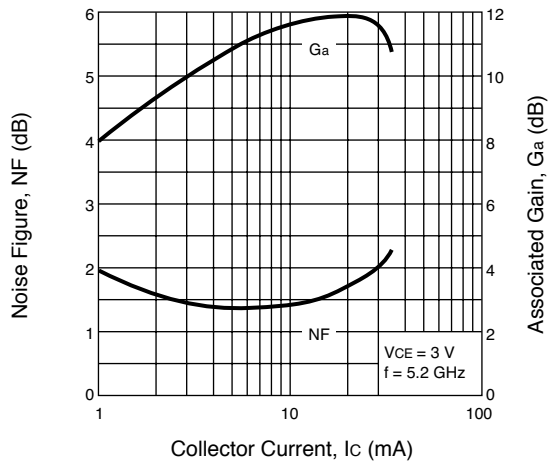



TYPICAL SCATTERING PARAMETERS (TA = 25°C)

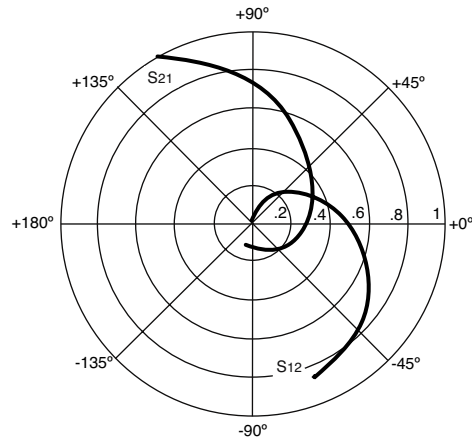
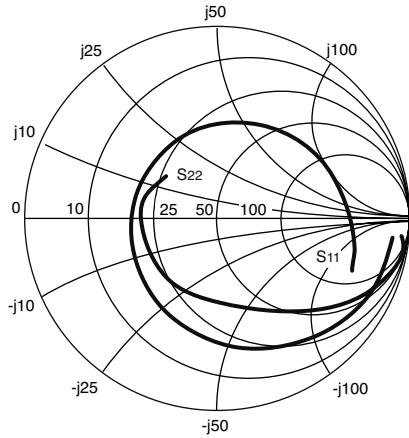

NESG2031M05  
Vc = 2 V, Ic = 5 mA

FREQUENCY GHz	S11		S21		S12		S22		K	MAG <sup>1</sup> (dB)
	MAG	ANG	MAG	ANG	MAG	ANG	MAG	ANG		
0.200	0.905	-17.55	13.476	166.44	0.015	75.48	0.961	-12.14	0.109	29.62
0.400	0.883	-35.30	12.930	153.01	0.027	67.20	0.917	-22.40	0.114	26.77
0.600	0.800	-50.74	11.773	139.58	0.036	57.16	0.838	-29.39	0.260	25.09
0.800	0.747	-65.74	10.912	128.86	0.044	50.21	0.774	-36.45	0.312	23.91
1.000	0.700	-79.13	10.032	119.48	0.050	44.20	0.717	-42.55	0.364	22.98
1.200	0.651	-91.64	9.211	110.79	0.055	39.35	0.668	-47.96	0.421	22.20
1.400	0.605	-103.05	8.432	102.94	0.059	34.88	0.624	-52.70	0.487	21.55
1.600	0.569	-114.06	7.754	95.75	0.062	31.30	0.586	-57.00	0.544	20.94
1.800	0.544	-123.33	7.158	89.32	0.065	28.57	0.557	-60.70	0.597	20.44
1.900	0.525	-128.19	6.874	86.26	0.066	27.02	0.542	-62.68	0.632	20.20
2.000	0.515	-132.91	6.638	83.05	0.067	25.54	0.529	-64.60	0.657	19.96
2.100	0.504	-137.65	6.391	80.23	0.068	24.56	0.517	-66.48	0.683	19.73
2.200	0.499	-141.94	6.159	77.36	0.069	23.62	0.508	-68.03	0.701	19.49
2.300	0.487	-145.95	5.948	74.61	0.070	22.54	0.496	-69.64	0.737	19.31
2.400	0.476	-150.04	5.744	71.95	0.071	21.41	0.488	-71.29	0.765	19.10
2.500	0.470	-154.38	5.553	69.39	0.072	20.20	0.481	-73.07	0.787	18.90
2.600	0.465	-158.84	5.379	66.64	0.073	19.38	0.474	-74.39	0.805	18.69
2.700	0.459	-162.43	5.214	64.24	0.073	18.80	0.468	-76.05	0.828	18.51
2.800	0.454	-166.08	5.060	61.68	0.074	18.02	0.462	-77.35	0.851	18.34
2.900	0.447	-170.06	4.915	59.28	0.075	17.16	0.456	-79.07	0.878	18.18
3.000	0.444	-173.81	4.761	57.03	0.076	15.82	0.453	-80.50	0.895	17.98
3.200	0.438	178.47	4.501	52.30	0.078	14.90	0.444	-83.07	0.932	17.64
3.400	0.428	171.27	4.273	47.78	0.079	13.32	0.440	-85.90	0.974	17.33
3.600	0.427	163.98	4.057	43.37	0.081	11.88	0.434	-88.27	1.003	16.66
3.800	0.423	157.49	3.872	39.01	0.082	11.04	0.430	-90.93	1.033	15.60
4.000	0.422	149.92	3.698	34.77	0.085	9.18	0.428	-93.39	1.055	14.98
4.200	0.426	143.92	3.541	30.51	0.087	8.09	0.426	-96.22	1.066	14.54
4.400	0.420	137.30	3.394	26.35	0.088	6.73	0.427	-98.70	1.096	13.97
4.600	0.428	130.50	3.262	22.21	0.091	4.94	0.422	-101.17	1.103	13.61
4.800	0.430	125.03	3.136	18.13	0.093	4.19	0.423	-103.93	1.115	13.23
5.000	0.434	118.39	3.023	14.16	0.094	2.32	0.423	-106.12	1.131	12.86
5.200	0.445	112.90	2.915	10.11	0.097	0.88	0.422	-108.86	1.117	12.68
5.400	0.445	107.35	2.823	6.11	0.099	-0.22	0.423	-111.50	1.133	12.34
5.600	0.456	101.71	2.727	2.18	0.102	-2.52	0.423	-114.31	1.123	12.15
5.800	0.461	96.57	2.643	-1.88	0.104	-3.64	0.421	-117.30	1.129	11.87
6.000	0.467	90.38	2.564	-5.81	0.106	-5.93	0.419	-119.34	1.136	11.60
7.000	0.515	69.13	2.189	-24.90	0.118	-14.29	0.414	-135.23	1.120	10.59
8.000	0.557	48.59	1.912	-43.02	0.129	-23.38	0.403	-148.98	1.113	9.68
9.000	0.603	28.65	1.706	-61.61	0.143	-33.62	0.392	-164.98	1.048	9.43
10.000	0.658	9.89	1.525	-80.10	0.154	-44.64	0.382	-177.36	0.981	9.96
11.000	0.711	-6.46	1.363	-98.43	0.163	-56.19	0.363	158.46	0.926	9.23
12.000	0.755	-21.02	1.228	-116.23	0.172	-68.02	0.339	141.23	0.863	8.54

Note:

1. Gain Calculations:

$$MAG = \frac{|S_{21}|}{|S_{12}|} \left( K \sqrt{K^2 - 1} \right). \text{ When } K \leq 1, \text{ MAG is undefined and MSG values are used. } MSG = \frac{|S_{21}|}{|S_{12}|}, K = \frac{1 + |\Delta|^2 - |S_{11}|^2 - |S_{22}|^2}{2 |S_{12} S_{21}|}, \Delta = S_{11} S_{22} - S_{21} S_{12}$$

MAG = Maximum Available Gain  
MSG = Maximum Stable Gain

TYPICAL SCATTERING PARAMETERS (TA = 25°C)

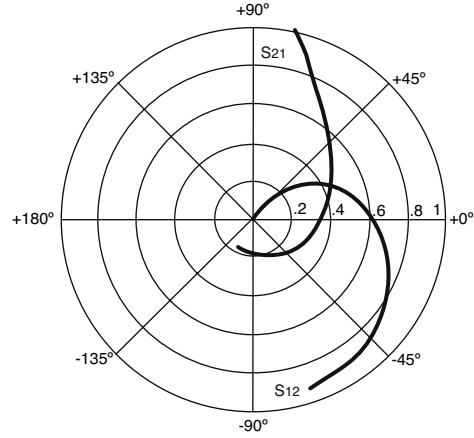
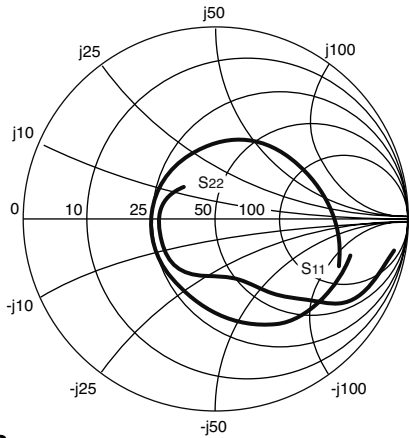

NESG2031M05  
Vc = 3 V, Ic = 20 mA

FREQUENCY	S11		S21		S12		S22		K	MAG <sup>1</sup>
GHz	MAG	ANG	MAG	ANG	MAG	ANG	MAG	ANG		(dB)
0.200	0.708	-33.56	31.847	155.43	0.012	69.94	0.900	-20.46	0.213	34.12
0.400	0.637	-61.48	27.290	136.26	0.021	59.98	0.780	-34.95	0.298	31.15
0.600	0.518	-82.49	22.132	121.08	0.026	52.67	0.640	-41.45	0.509	29.31
0.800	0.461	-100.68	18.546	110.17	0.030	49.46	0.553	-47.16	0.613	27.88
1.000	0.420	-115.61	15.806	101.52	0.034	47.24	0.492	-51.33	0.703	26.70
1.200	0.392	-128.84	13.698	94.16	0.037	45.92	0.447	-54.73	0.777	25.65
1.400	0.368	-140.59	12.043	87.72	0.040	44.81	0.413	-57.58	0.849	24.74
1.600	0.355	-151.34	10.718	81.98	0.044	43.65	0.387	-60.38	0.897	23.87
1.800	0.346	-159.30	9.668	76.77	0.047	43.13	0.369	-62.78	0.940	23.11
1.900	0.338	-164.24	9.203	74.27	0.049	42.43	0.359	-64.30	0.965	22.75
2.000	0.336	-168.72	8.784	71.82	0.051	41.66	0.353	-65.82	0.979	22.39
2.100	0.336	-172.82	8.392	69.48	0.053	41.25	0.347	-67.17	0.991	22.03
2.200	0.339	-176.22	8.044	67.14	0.054	40.82	0.342	-68.42	0.996	21.69
2.300	0.333	-179.74	7.721	64.88	0.056	40.34	0.335	-69.73	1.018	20.57
2.400	0.328	176.30	7.423	62.68	0.058	39.52	0.332	-71.16	1.032	20.00
2.500	0.330	172.28	7.145	60.59	0.060	38.73	0.328	-72.87	1.039	19.58
2.600	0.333	168.38	6.883	58.42	0.061	38.00	0.326	-73.90	1.043	19.23
2.700	0.331	165.77	6.647	56.32	0.063	37.44	0.324	-75.39	1.049	18.85
2.800	0.330	162.65	6.427	54.22	0.065	36.74	0.321	-76.62	1.058	18.47
2.900	0.329	159.11	6.217	52.17	0.067	35.95	0.319	-78.23	1.069	18.09
3.000	0.329	155.33	6.021	50.20	0.068	34.78	0.319	-79.69	1.076	17.77
3.200	0.334	149.17	5.659	46.20	0.072	33.45	0.316	-82.02	1.078	17.23
3.400	0.331	142.72	5.350	42.30	0.076	31.50	0.316	-84.98	1.092	16.64
3.600	0.336	136.40	5.067	38.48	0.080	29.62	0.315	-87.26	1.092	16.19
3.800	0.337	131.32	4.820	34.66	0.083	28.04	0.315	-90.01	1.097	15.73
4.000	0.341	124.22	4.594	30.92	0.087	25.60	0.317	-92.54	1.096	15.34
4.200	0.349	119.76	4.390	27.12	0.091	23.76	0.318	-95.60	1.090	15.01
4.400	0.346	113.85	4.203	23.39	0.094	21.66	0.322	-98.23	1.101	14.57
4.600	0.358	108.10	4.030	19.68	0.098	19.29	0.320	-100.73	1.094	14.29
4.800	0.362	103.90	3.872	16.02	0.101	17.49	0.323	-103.62	1.092	13.98
5.000	0.368	97.89	3.730	12.41	0.104	15.10	0.324	-105.88	1.092	13.68
5.200	0.382	93.59	3.594	8.74	0.108	12.73	0.326	-108.77	1.076	13.53
5.400	0.382	89.01	3.478	5.09	0.111	10.83	0.328	-111.53	1.080	13.22
5.600	0.395	84.15	3.358	1.42	0.115	8.04	0.329	-114.59	1.069	13.05
5.800	0.400	80.23	3.252	-2.29	0.118	5.95	0.328	-117.73	1.068	12.80
6.000	0.407	74.50	3.159	-5.94	0.121	3.25	0.325	-119.95	1.068	12.56
7.000	0.455	57.61	2.710	-23.72	0.136	-8.42	0.319	-136.55	1.049	11.63
8.000	0.497	39.73	2.384	-40.91	0.149	-20.28	0.305	-149.86	1.039	10.83
9.000	0.543	22.18	2.143	-58.86	0.163	-32.76	0.293	-166.22	0.999	11.19
10.000	0.599	5.55	1.932	-76.86	0.172	-45.34	0.280	175.13	0.964	10.50
11.000	0.655	-8.97	1.741	-95.01	0.179	-58.02	0.255	154.83	0.931	9.87
12.000	0.702	-22.22	1.589	-112.88	0.185	-70.97	0.220	138.01	0.889	9.33

Note:

1. Gain Calculations:

$$MAG = \frac{|S_{21}|}{|S_{12}|} (K \sqrt{K^2 - 1}). \text{ When } K \leq 1, \text{ MAG is undefined and MSG values are used. } MSG = \frac{|S_{21}|}{|S_{12}|}, K = \frac{1 + |\Delta|^2 - |S_{11}|^2 - |S_{22}|^2}{2 |S_{12}| |S_{21}|}, \Delta = S_{11} S_{22} - S_{21} S_{12}$$

MAG = Maximum Available Gain

MSG = Maximum Stable Gain

**OUTLINE DIMENSIONS** (Units in mm)

**PACKAGE OUTLINE M05**  
**FLAT LEAD 4-PIN THIN TYPE SUPER MINIMOLD**

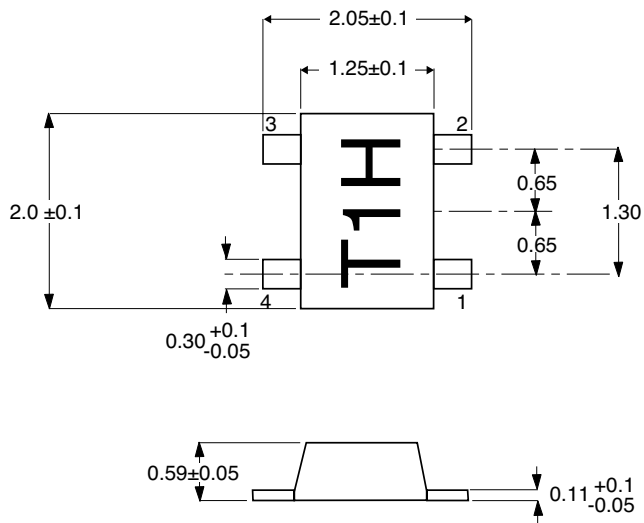
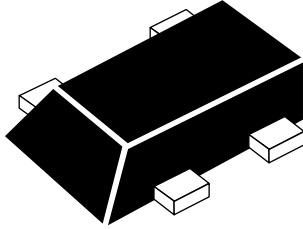

**PIN CONNECTIONS**

- 1. Base
- 2. Emitter
- 3. Collector
- 4. Emitter

NONLINEAR MODEL

SCHEMATIC

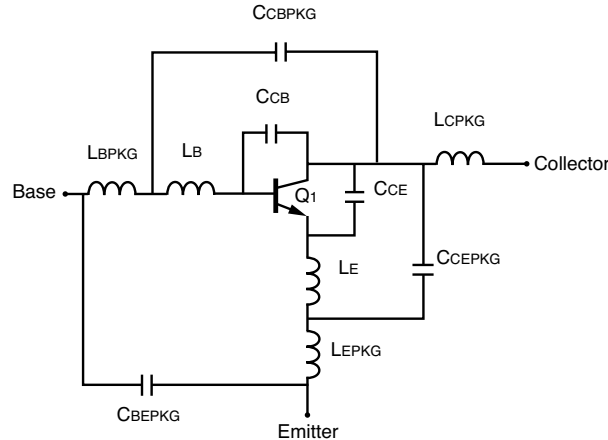

BJT NONLINEAR MODEL PARAMETERS<sup>(1)</sup>

Parameters	Q1	Parameters	Q1
IS	1.593e-15	MJC	0.125
BF	305.3	XCJC	1
NF	1.099	CJS	0
VAF	35.92	VJS	0.75
IKF	94.86e-3	MJS	0
ISE	27.45e-15	FC	0.8
NE	2.035	TF	4e-12
BR	21.10	XTF	10
NR	1.066	VTF	5
VAR	2.782	ITF	0.5
IKR	20.46e-3	PTF	20
ISC	11.77e-18	TR	0
NC	2.0	EG	1.11
RE	1.6	XTB	1.3
RB	1.0	XTI	5.2
RBM	50e-3	KF	0
IRB	1e-4	AF	1
RC	7.2		
CJE	642e-15		
VJE	751e-3		
MJE	93.06e-3		
CJC	163.4e-15		
VJC	0.56		

(1) Gummel-Poon Model

Life Support Applications

These NEC products are not intended for use in life support devices, appliances, or systems where the malfunction of these products can reasonably be expected to result in personal injury. The customers of CEL using or selling these products for use in such applications do so at their own risk and agree to fully indemnify CEL for all damages resulting from such improper use or sale.

ADDITIONAL PARAMETERS

Parameters	NESG2031M05
CCB	0.01 pF
CCE	0.07 pF
LB	0.25 nH
LE	0.15 nH
CCBPKG	0.13 pF
CCEPKG	0.01 pF
CBEPKG	0.03 pF
LBPKG	0.9 nH
LCPKG	1.0 nH
LEPKG	0.19 nH

MODEL TEST CONDITIONS

Frequency: 0.1 to 6 GHz  
 Bias:  $V_{CE} = 2\text{ V}$ ,  $I_C = 1\text{ mA}$  to  $20\text{ mA}$   
 Date: 09/2003

Subject: Compliance with EU Directives

CEL certifies, to its knowledge, that semiconductor and laser products detailed below are compliant with the requirements of European Union (EU) Directive 2002/95/EC Restriction on Use of Hazardous Substances in electrical and electronic equipment (RoHS) and the requirements of EU Directive 2003/11/EC Restriction on Penta and Octa BDE.

CEL Pb-free products have the same base part number with a suffix added. The suffix –A indicates that the device is Pb-free. The –AZ suffix is used to designate devices containing Pb which are exempted from the requirement of RoHS directive (\*). In all cases the devices have Pb-free terminals. All devices with these suffixes meet the requirements of the RoHS directive.

This status is based on CEL’s understanding of the EU Directives and knowledge of the materials that go into its products as of the date of disclosure of this information.

Restricted Substance per RoHS	Concentration Limit per RoHS (values are not yet fixed)	Concentration contained in CEL devices	
		-A	-AZ
Lead (Pb)	< 1000 PPM	Not Detected	(*)
Mercury	< 1000 PPM	Not Detected	
Cadmium	< 100 PPM	Not Detected	
Hexavalent Chromium	< 1000 PPM	Not Detected	
PBB	< 1000 PPM	Not Detected	
PBDE	< 1000 PPM	Not Detected	

If you should have any additional questions regarding our devices and compliance to environmental standards, please do not hesitate to contact your local representative.

Important Information and Disclaimer: Information provided by CEL on its website or in other communications concerning the substance content of its products represents knowledge and belief as of the date that it is provided. CEL bases its knowledge and belief on information provided by third parties and makes no representation or warranty as to the accuracy of such information. Efforts are underway to better integrate information from third parties. CEL has taken and continues to take reasonable steps to provide representative and accurate information but may not have conducted destructive testing or chemical analysis on incoming materials and chemicals. CEL and CEL suppliers consider certain information to be proprietary, and thus CAS numbers and other limited information may not be available for release.

In no event shall CEL’s liability arising out of such information exceed the total purchase price of the CEL part(s) at issue sold by CEL to customer on an annual basis.

See CEL Terms and Conditions for additional clarification of warranties and liability.