



**Zeus Parallel ATA (PATA)
2.5-Inch Solid State Drive
Product Datasheet**



Export Administration Regulations

This document may contain technical data controlled by the U.S. Export Administration Regulations, and may be subject to the approval of the U.S. Department of Commerce prior to export. Any export, directly or indirectly, in contravention of the U.S. Export Administration Regulation is prohibited.

Trademark Information

The STEC name, logo and design are trademarks of STEC Inc. No right, license, or interest to such trademarks is granted hereunder, and you agree that no such right, license, or interest shall be asserted by you with respect to such trademark. Other product and corporate names mentioned in this document are used for identification purposes only and may be trademarks or registered trademarks of their respective companies.

Disclaimer of Liability

The performance information and specifications furnished in this document reflect the engineering development objectives of STEC Inc. and should be used for comparative analysis and reference purposes. The content of this document is accurate as of the date of this publication; however, the information contained herein, including but not limited to any instructions, descriptions and product specifications, is subject to change without prior notice.

STEC INC. (STEC) PROVIDES NO WARRANTY WITH REGARD TO THIS DOCUMENT OR ANY OTHER INFORMATION CONTAINED HEREIN AND HEREBY EXPRESSLY DISCLAIMS ANY IMPLIED WARRANTIES OF MERCHANTABILITY OR FITNESS FOR ANY PARTICULAR PURPOSE WITH REGARD TO ANY OF THE FOREGOING. STEC INC. ASSUMES NO LIABILITY FOR ANY DAMAGES INCURRED DIRECTLY OR INDIRECTLY FROM ANY TECHNICAL OR TYPOGRAPHICAL ERRORS OR OMISSIONS CONTAINED HEREIN. IN NO EVENT SHALL STEC INC. BE LIABLE FOR ANY INCIDENTAL, CONSEQUENTIAL, SPECIAL, OR EXEMPLARY DAMAGES, WHETHER BASED ON TORT, CONTRACT OR OTHERWISE, ARISING OUT OF OR IN CONNECTION WITH THIS DOCUMENT OR ANY OTHER INFORMATION CONTAINED HEREIN OR THE USE THEREOF.

Copyright Notice

Copyright © 2007 by STEC Inc. All rights reserved. Information contained in this document, including but not limited to any instructions, descriptions and product specifications, is proprietary to STEC Inc. and shall not be modified, used, copied, reproduced or disclosed in whole or in part, in any form or by any means, electronic or mechanical, for any purpose, without the written consent of STEC Inc.

CONVENTIONS

The following icons are used throughout this document to identify additional information of which the reader should be aware.



SHOCK HAZARD: This icon indicates the danger of an electrical shock that may harm or otherwise prove fatal to the user.



CAUTION: This icon indicates the existence of a hazard that could result in equipment or property damage or equipment failure if the safety instruction is not observed.



ELECTROSTATIC DISCHARGE: This icon indicates the possible presence of Electrostatic Discharge (ESD or “static electricity”) that may harm the internal electronic components. The user is advised to handle the device only after discharging any possible electrostatic buildup that may be present.



NOTE: This icon identifies information that relates to the safe operation of the equipment or related items.



TIP: This icon identifies helpful hints and tips.



REVISION HISTORY

Revision Status Summary Sheet

Revision	Date	Sheet(s) Affected
0.1	01/20/2007	All. Initial release. Preliminary product datasheet.
1.0	04/20/2007	Official release.
1.1	05/23/2007	Minor grammatical corrections throughout datasheet. Updated ATA Commands and Environmental Characteristics sections.
1.2	06/11/2007	Page 7 - updated values for "Power consumption" bullets. Page 14 - updated Table 5, "SSD Typical Power Consumption"; Page 15 - added "Start-Up Time and Current Draw" topic and curve illustration (Figure 2).
1.3	06/18/2007	Minor spelling and grammatical corrections throughout datasheet. Page 11 - removed "Erase Cycles" topic.
1.4	06/28/2007	Page 57 - removed "Firmware Upgrades" topic.
1.5	07/09/2007	All - removed any reference to "2,000,000 write/erase cycles". Minor spelling and grammatical corrections.



TABLE OF CONTENTS

Conventions	iii
Revision History	v
List of Tables	xiv
List of Figures	xv
Scope	1
Overview	1
Audience	1
Standards and Reference Documents	1
Standard Features and Optional Features	2
Product Description	2
Performance Characteristics	2
Electrical Specifications	2
Interface Specifications	2
ATA Commands	2
Physical Characteristics	2
Environmental Characteristics	2
Installation	2
Regulatory Compliance	2
Contact and Ordering Information	3
Standards and Reference Documents	3
Electromagnetic Susceptibility	3
Electromagnetic Compatibility	3
Military Information Systems Security Standards	4
Commercial Standards	4
Reference Documents	5
Standard Features	5
Interface	5
Performance	5

Unformatted Capacities	5
Reliability	6
Physical Characteristics.....	6
Environmental Characteristics	6
Compliance.....	7
Power.....	7
Optional Features	7
Optional Purge Features.....	8
Optional Environmental Features	8
Manufacturing.....	8
Product Description	9
General Description.....	9
ATA Interface.....	9
Drive Capacities	9
Performance	9
Data Security.....	9
Performance Characteristics	10
ATA (IDE) Bus Modes	10
Endurance	10
Wear-Leveling	10
Bad-Block Management	10
Data Retention.....	10
Error Detection and Correction.....	11
Reliability	11
Error Rates	11
Built-In Self Test (BIST).....	11
Mount Time.....	11
Seek Time.....	11
Data Transfer Rates	12
Purge Times	12

Repairs.....	12
Preventative Maintenance	12
Electrical Specifications	13
Power Requirements	13
Power Consumption.....	13
Start-Up Time and Current Draw	14
Activity LED.....	14
Power Savings Commands.....	15
Power Mode at Power On.....	15
Grounding	15
Interface Specifications	16
SSD Operation.....	16
Primary and Secondary Modes.....	17
I/O Primary and Secondary ATA (IDE) Modes	17
Addressing Modes	17
Functional Blocks.....	18
ATA (IDE) Bus Interface Block.....	18
2.5-Inch 44-Pin ATA Bus Connector	18
Connector Pinout	19
SSD Control Block	21
ATA Commands	22
Standard ATA Commands.....	22
Standard ATA Command Summary	24
Check Power Mode (98h or E5h).....	24
Download Microcode (92h).....	24
Erase Sector (C0h)	24
Execute Drive Diagnostic (90h)	24
Flush Cache (E7h).....	24
Flush Cache Extended (EAh)	24
Format Track (50h)	25

Identify Response (ECh).....	25
Idle (97h, E3h)	25
Idle Immediate (95h, E1h)	25
Initialize Drive Parameters (91h)	25
NOP (00h).....	25
Read Buffer (E4h).....	25
Read DMA (C8h)	25
Read DMA Ext (25h).....	25
Read DMA Queued (C7h)	26
Read DMA Queued Ext (26h).....	26
Read Multiple (C4h).....	26
Read Multiple Extended (29h)	26
Read Sector(s) (20h)	26
Read Sector(s) Extended (24h)	26
Read/Verify Sector(s) (40h)	26
Read/Verify Extended (42h)	26
Recalibrate (10h)	27
Security Disable Password (F6h)	27
Security Erase Prepare (F3h)	27
Security Erase Unit (F4h)	27
Security Freeze Lock (F5h)	27
Security Set Password (F1h).....	27
Security Unlock (F2h)	27
Seek (70h, 7Fh)	28
Set Features (EFh)	28
Set Multiple Mode (C6h)	28
Set Sleep Mode (99h or E6h)	28
Sleep (E6h).....	28
SMART (B0h)	28
Standby (96h or E2h).....	28
Standby Immediate (94h or E0h).....	29
Write Buffer (E8h)	29

Write DMA (CAh)	29
Write DMA Ext (35h)	29
Write DMA Queued (CCh)	29
Write DMA Queued Ext (38h)	29
Write Multiple (C5h)	29
Write Multiple Ext (39h).....	29
Write Sector(s) (30h).....	30
Write Sector(s) Ext (34h)	30
SMART Support.....	30
Identify Device Information	30
Vendor-Specific ATA Commands	40
Sanitize Erase/Fill	40
Sanitization Standards	41
Physical Characteristics	42
General Physical Characteristics	42
Materials	42
Drive Assembly Weight.....	42
Storage Capacities.....	42
Exterior Dimensions.....	43
ATA Connector Location.....	44
Environmental Characteristics	45
Overview	45
Operating Temperatures.....	45
Operating Requirements.....	45
Non-Operating Requirements	46
Relative Humidity	46
Altitude Parameters	46
Restriction of Hazardous Materials	47
Shock and Vibration.....	47
Failure Criteria	47

Random Vibration	47
Shock	47
Drop Testing	48
Conformal Coating	48
Installation	49
System Requirements	49
Drive Configuration	50
Jumper Pins	50
Drive Orientation	51
Cooling Requirements	52
Installation Dimensions	53
Mounting Hole Locations	54
Drive Installation	55
Grounding Requirements	55
Operating System Specifications	56
Microsoft OS Compatibility	56
Non-Microsoft OS Compatibility	56
System POST, Boot and Resume Times	56
NAND Flash Support	56
Diagnostic Software	56
Regulatory Compliance	57
Marks, Approvals and Documentation	57
CB Certificate and CB Report	58
Declaration of Conformity	58
Radio Frequency Emissions	58
Radio Frequency Immunity Requirements	59
EMI Test Site Correlation	59
Verification Samples	59
Verification Testing	59

Electrostatic Discharge (ESD)	60
Acceptance Criteria Definitions.....	60
Contact and Ordering Information61
Contact Information.....	61
Ordering Information.....	61
Acronyms and Abbreviations63
Index67
Certification and Warranty	Inside Back Cover

LIST OF TABLES

1. Error Limits	11
2. Data Transfer Rates	12
3. Purge Times	12
4. Zeus 2.5-Inch SSD Power Requirements.....	13
5. SSD Typical Power Consumption	13
6. ATA (IDE) Bus Addressing Modes	17
7. ATA Connector Pinout Configuration	19
8. Supported ATA Commands.....	22
9. SSD Identify Device Information.....	31
10. Sanitize Standards Compliance	41
11. Zeus ATA SSD Capacities	42
12. 2.5 Drive Assembly Dimensions.....	43
13. Operating Temperatures	45
14. Operating Requirements	45
15. Non-Operating Requirements.....	46
16. Relative Humidity Criteria	46
17. Operating and Non-Operating Altitudes	46
18. Random Vibration Levels	47
19. Shock Test Results.....	47
20. ATA (IDE) Cable Requirements	49
21. Regulatory Marks and Documentation	57
22. EMI Specification Limits	58
23. ESD Requirements.....	60
24. Acceptance Criteria Definitions	60

LIST OF FIGURES

1. The Zeus 2.5-Inch ATA Solid State Drive	1
2. Start-Up Current Draw	14
3. 44-pin ATA (IDE) Bus Connector.....	18
4. Zeus 2.5-inch ATA SDD Exterior Dimensions	43
5. ATA Connector Location.....	44
6. Primary/Secondary Setting for 2.5-inch Zeus ATA SSDs.....	50
7. Possible Drive Orientations	51
8. Suggested Air Flow Patterns for Cooling.....	52
9. Exterior Mounting Specifications	53
10. Zeus 2.5-Inch Mounting Hole Locations	54



SCOPE



Figure 1. The Zeus 2.5-Inch ATA Solid State Drive

OVERVIEW

This datasheet describes the applications, specifications, and installation of the 2.5-inch Zeus ATA Solid State Drive (SSD). The contents of this datasheet can be quickly ascertained by reviewing the abstracts described under the *Scope* section.

AUDIENCE

This datasheet is intended for system engineers or system designers employed by an Original Equipment Manufacturer (OEM). This datasheet was therefore written specifically for a technically advanced audience; it is not intended for end-users that will eventually purchase the commercially available product. The *user*, as referenced throughout this document, is primarily concerned with industrial, commercial, or military applications.

Standards and Reference Documents

This section discusses the formal standards that may apply to the Zeus 2.5-Inch ATA SSD, including electrical product standards and military information security standards. In addition, this section lists reference documents relevant to the ATA protocols used for the Zeus ATA SSD.

Standard Features and Optional Features

These two sections list the standard and optional features of the Zeus 2.5-Inch ATA SSD.

Product Description

This section provides a general description of the Zeus 2.5-Inch ATA SSD, and includes media, performance, reliability and capacity information.

Performance Characteristics

This section describes the internal and seek characteristics of the Zeus ATA SSD and includes information on the access execution times.

Electrical Specifications

This section describes the power requirements and power consumption parameters of the Zeus ATA SSD and includes explanations of power-saving commands supported by the drive.

Interface Specifications

This section provides a table of the connector pinout and tables of the electrical characteristics for the pin signals. In addition, this section describes how the drive uses the pin signals when interacting with the host system.

ATA Commands

This section provides a table of the ATA commands supported by the Zeus 2.5-Inch ATA SSD, followed by a subtopic discussing the use of each command.

Physical Characteristics

This section describes the overall physical dimensions of the SSD, the materials used in its construction, and the average weight of the assembly.

Environmental Characteristics

The general operating and non-operating conditions for the Zeus SSD are detailed in this section. This section includes operating temperatures, relative humidity, altitude, and shock, drop and vibration testing results.

Installation

This section discusses issues relating to the installation of the Zeus 2.5-Inch ATA SSD in a PC or alternate enclosure, including cooling and grounding.

Regulatory Compliance

This section provides an overview of the marking, approval, documentation and reporting conventions for the Zeus 2.5-Inch ATA SSD.

Contact and Ordering Information

Please consult this section if you need to contact the Solid State Drive Team. The Ordering Information table allows you to decode the part number found on your model of Zeus drive.

Standards and Reference Documents

This section discusses the various standards for electronic products and military use, and how those standards apply to the Zeus 2.5-Inch ATA SSD.

Electromagnetic Susceptibility

The Zeus 2.5-inch ATA SSD is intended for installation by the user in an appropriate enclosure, i.e., a PC or alternate enclosure. The enclosure must be designed so that the use of the Zeus drive does not impair nearby electronic equipment within the same enclosure and external to the enclosure.

The *user*, as previously defined under the *Audience* section, is responsible for choosing designing and testing the enclosure so that it is appropriate as previously defined, and complies to related regulations, such as Subpart B of Part 125 of FCC Rules and Regulations, and Radio Interference Regulations of the Canadian Department of Communications.

Electromagnetic Compatibility

Independent laboratories are in the process of confirming that the Zeus 2.5-inch ATA SSD meets the requirements for CE Marking. While the drive may have CE Marking, the OEM must confirm CE Marking for the product in which the drive has been integrated. Test systems confirming the CE Marking may include the following:

- A current microprocessor
- Floppy diskette drive
- Keyboard
- Monitor
- Printer
- External modem
- Mouse

Military Information Systems Security Standards

The Zeus 2.5-inch ATA SSD complies in whole or part with the following Military Information Systems security standards:

- DoD 5220.22-M
- MIL-STD-810F
- NSA 130-2
- AR 380-19
- AFSSI 5020
- Navso-P5239
- NEBS Level 3

Commercial Standards

Zeus SSDs comply, in whole or in part, with the following commercial standards:

- S/NZS 3548 Class B
- BSMI CNS 13438 Class B
- CAN/CAS-V3/2001.04 (VCCI)
- CE (Conformite Europeenne)
- CISPR 22 Class B
- EN 55022 Class B
- EN 61000-3-2
- EN 61000-3-3
- FCC Part 15 Class B
- Underwriters Laboratories (UL)
- NEBS Level 3
- IEC 61000-4-2
- IEC 61000-4-3
- IEC 61000-4-4
- IEC 61000-4-5
- IEC 61000-4-6
- IEC 61000-4-8
- IEC 61000-4-11

Reference Documents

The following list of ANSI documents are relevant to the Zeus 2.5-inch ATA SSD:

- ANSI-INCITS 361-ATA-6
- ANSI-INCITS 340-ATA-5
- ANSI-INCITS 317-ATA-4
- ANSI-X3.298-1997-ATA-3
- ANSI-X3.279-1996-ATA-2

Standard Features

Interface

- Conforms to ATA-6 Specification Standard
- 16-bit interface
- Primary/Secondary jumper
- Low-level format at factory; shipped with NTFS format
- No special drivers required

Performance

- Fast initialization
- Supports PIO Modes 0 - 4
- Supports Ultra DMA Modes 0 - 5
- Burst Read/Write performance up to 66 MB/sec
- Sustained Read/Write up to 40 MB/sec

Unformatted Capacities

- 8, 16, 32 and 64 gigabytes
- Endurance
- Supports unlimited Read cycles
- Wear-leveling algorithms
- Bad-block mapping algorithms

Reliability

- Solid state design
- Data integrity: 10-year data retention
- Manual and automatic self-diagnostic tests
- Embedded EDC/ECC (Error Detection and Error Correction)
- Dependable operation under unstable power conditions
- Rugged, impact-resistant casing
- 5 year warranty

Physical Characteristics

- Larger capacities available as custom design
- Industry-standard 2.5-inch HDD form factor, precision machined aluminum alloy enclosure
- Compact design: 100.2mm (L) x 69.8mm (W) x 9.5mm (H)
- Weight: < 0.4 kg

Environmental Characteristics

- Two operating temperature ranges available:
 - Commercial range: 0°C to 70°C
 - Industrial range: -40°C to 85°C
- Storage Temperature of -55°C to 95°C
- Humidity of 5% to 95% relative, non-condensing
- Operating altitude of 80,000 feet
- Operating Shock of 1,500G, MIL-STD-810F (0.3 to 0.75ms duration, half-sine, 3 cycles per axis)
- Operating Vibration of 16.3G RMS, MIL-STD-810F (Random, 20Hz to 2,000Hz; 1 hour duration, 3 axes)
- 0dB Noise Amplitude

Compliance

- Meets NEBS Level 3 requirements for telco electrical environments.
- Meets U.S. Army, Navy, Air Force and DoD security erase and sanitization (purge) guidelines.
- Meets UL 1950 requirements for Electrical Equipment sold in the United States of America and is marked accordingly.
- Compliance with CSA CAN/CSA-C22.2, No. 950-M89 requirements for Electrical Equipment sold in Canada and is marked accordingly.
- Compliance with European Community (European Union) Information Technology Equipment (ITE) directives.
- MIC (Korean) certified.
- BSMI (Taiwan) certified.
- VCCI (Japan) certified.
- C-Tick (Australia) certified.
- FCC Declaration of Conformity (DoC).

Power

- Input voltage: 5V DC +/-5%
- Typical power consumption:
 - Start-Up: 333.60mA
 - Idle: 375mA
 - Read: 560mA
 - Write: 545mA

Optional Features

- SMART (Self-Monitoring, Analysis and Reporting Technology) status monitoring.
- Sanitization ("Sanitize Erase/Fill")

Optional Purge Features

- BasicPurge™: Erases solid state drive
- RapidPurge™: Erases solid state drive in seconds
- MilPurge™: Erases solid state drive in compliance with security guidelines (DoD 5220.22-M, NSA 130-2, AFSSI 5020, AR 380-19 and Navso 5239)
- Intelligent Destructive Purge™: Physically damages the flash media to make data retrieval impossible
- Hardware Purge

Optional Environmental Features

- Conformal coating

Manufacturing

- Santa Ana, California
United States of America
- ISO 9001 Certified

PRODUCT DESCRIPTION

General Description

The Zeus 2.5-inch ATA Solid State Drive (SSD) is a non-volatile, mass storage device. The drive is intended as a replacement for a standard IDE/ATA-compliant hard disk drive (HDD). No additional device drivers are required, and the drive can be configured as a boot or data storage device.

ATA Interface

The SSD can be installed in any operating system environment that supports ATA-6 or greater devices. The drive is configured with a standard 44-pin IDE/ATA interface, is fully ATA-6 compliant, and conforms to the same mechanical and mounting requirements as standard rotating disk drives. The drive supports Primary/Secondary (Device 0/Device 1) mode operation via a set of jumper pins.

Drive Capacities

The SSD is available in unformatted memory capacities of 8, 16, 32 and 64 gigabytes. The memory consists of Single-Level Cell (SLC) NAND Flash components.

Performance

Zeus SSDs can operate at sustained data transfer rates of up to 40 MB per second. Power consumption is kept to a minimum; the SSDs can be powered from a single 5-volt source. The solid state design eliminates electromechanical noise and delay inherent in traditional magnetic rotating media. The wear-leveling and bad-block mapping algorithms ensure consistency, accuracy, and integrity of user data. Data reliability is achieved through embedded Error Detection and Error Correction Code (EDC/ECC).

Data Security

Zeus SSDs offer optional user-defined data sanitization (purge) features. Supporting both sanitized erase/fill and non-recoverable sanitization options, the SSDs can be configured to remove data from the drive, freeing storage space for later reuse, or to remove data and destroy the storage media, making the SSD unusable and data retrieval impossible. The data security features of the drives comply with Department of Defense (DoD) and US military data security standards, including AFSSI 5020, AR 380-19, NAVSO P-5239-26, NISPOM DoD 5220.22-M and NSA 130-2.

PERFORMANCE CHARACTERISTICS

ATA (IDE) Bus Modes

Zeus SSDs support the following ATA operating modes:

- PIO Modes 0 - 4
- DMA Modes 0 - 2
- Ultra DMA Modes 0 - 5

Endurance

The useful life of flash media is limited by the number of write/erase operations that can be performed on the media. To extend the useful life of the SSD, special wear-leveling and bad-block mapping algorithms are integrated in the firmware.

Wear-Leveling

The dynamic wear-leveling algorithm integrated in the firmware guarantees that erase/write cycles are evenly distributed across all of the flash memory block locations. Wear-leveling eliminates repeated writes to the same physical flash memory location, thereby preventing blocks from premature wear.

Bad-Block Management

The bad-block mapping algorithm replaces bad blocks with new ones from available spares. Two percent (2%) of the flash memory is held in reserve (spare block) for bad block replacement. Bad blocks in the media are flagged when detected. The next time an attempt is made to access a flagged block, it is immediately replaced by a spare block. The bad block mapping function enables data to be automatically transferred from a bad sector to an available spare block.

Notes:

- 1 STEC Inc. scans for bad blocks during the manufacturing process at the initial installation of the flash components. Bad blocks are mapped and identified during the manufacturing process.
- 2 The maximum amount of available user space will not be less than 97% of the total flash capacity, i.e., the reserved space will not exceed more than 3% of the total drive volume

Data Retention

Data stored on a Zeus SSD will remain valid for ten (10) years without requiring power support. The unit can be stored under certain environmental conditions for extended periods without any occurrence of data degradation.

Error Detection and Correction

The Error Detection Code and Error Correcting Code (EDC/ECC) helps maintain data integrity by allowing single or multiple bit corrections to the data stored in the flash array. If the data in the flash array is corrupted due to aging or during the programming process, the EDC/ECC will compensate for the errors to ensure the delivery of accurate data to the host computer. The EDC/ECC engine is capable of correcting up to 4 bytes in error and detecting up to 5 bytes in error. An extensive retry algorithm is also implemented on all Zeus SSDs, so that single event disturbances such as ESD or EMF occurring during a read operation can be readily overcome.

Reliability

- DC power is maintained as specified in the datasheet
- Errors caused by the host are excluded from rates
- Errors from the same causes are counted as 1 block
- Data stream is assumed random

Error Rates

Table 1 lists the error limit specifications. When all data correction mechanisms are enabled, the error rate will be sustained through all operating temperature ranges as specified in the previous sections.

Table 1. Error Limits

Error Type	Maximum Number of Errors
Recoverable Data Error	1 bit in 10^{20}
Unrecoverable Data Error	Less than 1 bit in 10^{20}

Built-In Self Test (BIST)

During power-up, the micro-controller tests the controller memory, and then performs a back-end status check to verify proper flash memory controller operations. If a fault condition is detected in the flash memory controller, the SSD's status is reported as failed.

Mount Time

The amount of time required to initialize and mount a Zeus SSD varies according to the operating system (Windows®, Linux®, etc.) in which the SSD is running and the storage capacity of the drive.

Seek Time

Unlike a magnetic rotating disk, the SSD has no read/write heads or platters. There is no seek time or rotational latency issues. The SSDs dramatically improve transaction throughput, particularly for applications that are configured to take advantage of the characteristics of the drive.

Data Transfer Rates

The data transfer rate varies according to the flash controller/flash memory configuration of the drive. The scalable architecture of the drive is capable of accommodating sustained and burst data transfer rates as listed in *Table 2*.

Table 2. Data Transfer Rates

Parameter	Value	Units
Average Access	0.3	m/sec
Average Latency	0.3	m/sec
Sustained Read	40	Megabytes/sec
Sustained Write	26	Megabytes/sec
Burst Read	66	Megabytes/sec
Burst Write	66	Megabytes/sec

Purge Times

The time required to purge a Zeus SSD depends on the actual purge option invoked by the user and the flash controller/flash memory configuration of the drive. A list of representative purge times is listed in *Table 3*, with the value expressed in seconds per 32 Gigabytes (sec/32GB) for each purge option.

Table 3. Purge Times

Purge Option	Value	Units
BasicPurge	360	sec/32GB
RapidPurge	9	sec/32GB
MilPurge	1,200	sec/32GB
Intelligent Destructive Purge	2	sec/32GB

Repairs

A defective SSD should be replaced. There are no parts, assemblies or subassemblies that can be repaired individually by the user. Please see the section titled *Certification and Warranty* on the inside of the back cover page. *Unauthorized repairs to the SSD will void the warranty.*

Preventative Maintenance

No preventative maintenance is required. The SSD unit is sealed at the factory, and there are no parts, assemblies, or subassemblies that require preventative maintenance on behalf of the user. Please see the section titled *Certification and Warranty* on the inside of the back cover page. *Unauthorized maintenance to the SSD will void the warranty.*

ELECTRICAL SPECIFICATIONS

Power Requirements

The SSD requires a 5V power source. If a power failure occurs, the drive design ensures that the data contained in the storage memory is preserved. Data loss or corruption does not occur.

Table 4. Zeus 2.5-Inch SSD Power Requirements

Item	Requirement
Input Voltage ¹	5V +/-5% (4.75V Min, 5.25V Max)
Ripple (0-30MHz)	70 mV p-p (for 3.3V)
Supply Rise Time	7 - 100 ms
Supply Fall Time	< 5s

Note: (1) The voltage rail, which includes ripples, does not exceed or fall below the voltage range as specified by the *Min* and *Max* values, i.e., the *Min* and *Max* numbers are the absolute floor and ceiling for the input voltages.

Power Consumption

The amount of power consumed by a Zeus SSD is determined by the storage (memory) capacity of the drive, and the flash controller/memory configuration of the drive. *Table 5* lists the typical power consumption of the drives per operation.

Table 5. SSD Typical Power Consumption

Operation	Power Consumption	
	Typical	Maximum
Idle	375mA	425mA
Read (40MB/sec)	400mA	560mA
Write (26MB/sec)	400mA	545mA

Start-Up Time and Current Draw

The Start-Up current was measured during the power-on phase of the computer and drive. The Start-Up time was ~850ms. *Figure 2* shows the current draw during start-up, with an average current of 333.5mA RMS.

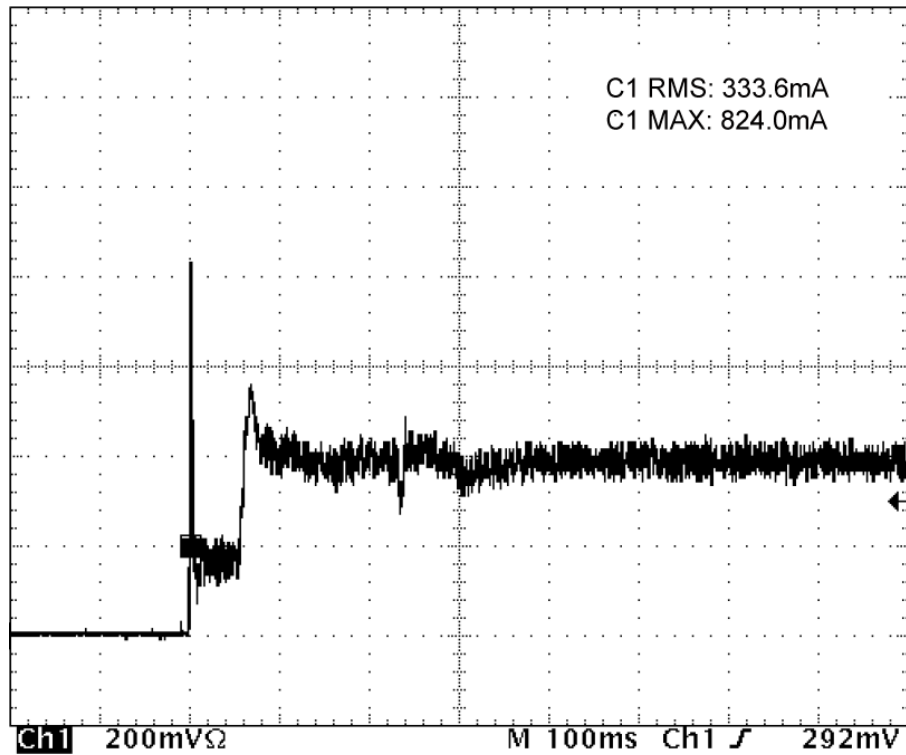

Figure 2. Start-Up Current Draw

Activity LED

Zeus SSDs are configured to drive Pin 39 (-DASP; Disk Present/Secondary Active) of the ATA cable during all command activity and during periods when the drive indicates a busy state. (Example: Off-line diagnostic activities.)

Power Savings Commands

Zeus SSDs support the following Power Savings commands and respond with the appropriate status:

- Check Power Mode
- Idle
- Standby
- Standby Immediate
- Sleep

The drives comply with all specifications that define the behavior of storage devices as it relates to power management and advanced power management (APM). When the SSDs receive a power management command, all data in the Write cache buffer is written to the media before Drive Ready is asserted.

Power Mode at Power On

The drives comply with the ATA-6 Power Management Specification. During the Power On Reset sequence, the drive functions properly and responds as appropriate. In addition, if a SRST (ATA Interface Reset) occurs during this sequence, the drives still respond normally. After power on or hard reset, the drive goes into IDLE or STANDBY mode, depending on the setting by the host.

Grounding

Signal and chassis grounds are connected together in the drive. To ensure minimal EM emissions, the user should provide maximum surface contact area when connecting the drive to the chassis ground.

INTERFACE SPECIFICATIONS

SSD Operation

The Zeus SSD comprises three primary functional blocks: the ATA (IDE) interface connector, Zeus SSD controller and NAND flash memory. A description of each drive component appears under *Functional Blocks*.

Read/write data transfer requests are initiated by the host via the ATA (IDE) bus interface. Once received, the Zeus controller, under the direction of the microcontroller, processes the request.



The microcontroller is responsible for initiating and controlling all activity within the Zeus controller, including bad-block mapping and executing the wear-leveling algorithms.



The Zeus controller decodes an incoming host command, and configures the appropriate interrupts and status for the local microprocessor to handle various ATA commands. For read and write transfer commands, the hardware can handle the initial handshake with the host automatically. If firmware enables full auto mode, read and write transfers can be fully handled by hardware with minimum firmware support.

Commands that do not require data to be read from or written to the flash memory controller are typically handled by the Zeus controller. Some commands may require the Zeus controller to use external circuitry (for example, Intelligent Destructive Purge™), that do not involve the flash memory controller.

When a write operation is requested and data is received, the controller uses integrated DMA controllers to transfer the data from host memory to the flash memory controller. Through a standard ATA (IDE) interface, the flash memory controller transfers the data from the Zeus controller to available locations in the local flash memory of the SSD. Zeus SSD storage capacity can range between from 8GB to 64GB, with internal IDE transfer rates of 26 MB per second. The Zeus controller notifies the host after the write operation is completed.

If a read request is received, the Zeus controller retrieves the data from the local flash memory via the flash memory controller. If the Zeus controller is responding to a PIO read operation, it presents the data to the ATA bus. If it is responding to a UDMA read request, the Zeus controller writes the data directly to system memory on the host. Regardless of the type of operation (PIO or UDMA), the Zeus controller notifies the host when the data is ready for transmission.

Primary and Secondary Modes

The Zeus SSD is configured as a high-performance I/O device and supports Primary (Device 0) and Secondary (Device 1) modes:

Device Mode	Description
Primary	Drive address at system ATA I/O address 1F0h - 1F7h and 3F6h - 3F7h. The host must provide chip-enable #CS0 and #CS1. The SSD decodes addresses DA0 - DA2.
Secondary	Drive address at system ATA I/O address 170h - 177h and 376h - 377h. The host must provide chip-enable #CS0 and #CS1. The SSD decodes addresses DA0 - DA2.

I/O Primary and Secondary ATA (IDE) Modes

Primary and secondary drive addressing modes allow hosts to use the ATA-standard's reserved disk drive I/O addresses. This provides system designers with the simplest way to accommodate ATA-protocol devices.

Addressing Modes

Zeus SSDs, on a command-by-command basis, can operate in either CHS or LBA addressing modes. Identify Drive Information (See *Identify Drive Information* on page 26.) signals the host whether the drive supports LBA mode. The host selects LBA mode via the Drive/Head register. Sector Number, Cylinder Low, Cylinder High, and Drive/Head register bits HS3=0 contain the zero-based LBA. The sectors are linearly mapped with: LBA = 0 => Cylinder 0, Head 0, Sector 1. Regardless of the translation mode, a sector LBA address does not change. LBA = (Cylinder * No of Heads + Head) * (Sectors/Track) + (Sector - 1). *Table 6* lists the supported IDE addressing modes.

Table 6. ATA (IDE) Bus Addressing Modes

#CS0	#CS1	DA2	DA1	DA0	#IORD - "0"	#IOWR - "0"
1	1	X	X	X	Hi-Z	Not Used
1	0	0	X	X	Hi-Z	Not Used
1	0	1	0	X	Hi-Z	Not Used
0	0	X	X	X	Invalid	Invalid
1	0	1	1	0	Alternate Status	Device Control
1	0	1	1	1	Device Address	Not Used
0	1	0	0	0	Data	Data
0	1	0	0	1	Error	Feature
0	1	0	1	0	Sector Count	Sector Count
0	1	0	1	1	Sector Number	Sector Number
0	1	1	0	0	Cylinder Low	Cylinder Low
0	1	1	0	1	Cylinder High	Cylinder High
0	1	1	1	0	Drive/Head	Drive/Head
0	1	1	1	1	Status	Command

Connector Pinout

Table 7 provides the signal assignment for each pin on the ATA (IDE) bus connector. The table applies to the 44-pin ATA bus/DC power combination connector used on 2.5-inch drives.

Table 7. ATA Connector Pinout Configuration

Pin	Pin Type	Signal Symbol	Signal Name	Signal Description
1	1	-RESET	HOST RESET	Reset signal from host. Reset is active on power up and inactive thereafter.
2	Ground	GND	-	Ground
3	I/O	D07	HOST DATA 07	Pins 3 through 18 (16 lines (15-0) carry the data between the controller and the host. The low 8 lines transfer commands and the ECC information between the host and the controller.
4	I/O	D08	HOST DATA 08	
5	I/O	D06	HOST DATA 06	
6	I/O	D09	HOST DATA 09	
7	I/O	D05	HOST DATA 05	
8	I/O	D10	HOST DATA 10	
9	I/O	D04	HOST DATA 04	
10	I/O	D11	HOST DATA 11	
11	I/O	D03	HOST DATA 03	
12	I/O	D12	HOST DATA 12	
13	I/O	D02	HOST DATA 02	
14	I/O	D13	HOST DATA 13	
15	I/O	D01	HOST DATA 01	
16	I/O	D14	HOST DATA 14	
17	I/O	D00	HOST DATA 00	
18	I/O	D15	HOST DATA 15	
19	Ground	GND	-	Ground
20	-	-	-	No connection. Reserved for connector key.
21	O	DREQ	DMA REQUEST	Not used.
22	Ground	GND	-	Ground
23	I	-IOWR	I/O WRITE	This I/O Write strobe pulse is used to clock I/O data or commands on the drive data bus into the drive controller registers when the drive is configured to use the I/O interface. The clocking will occur on the negative to positive edge of the signal (trailing edge).
24	Ground	GND	-	Ground
25	I	-IORD	I/O READ	This is a Read strobe generated by the host. The signal gates I/O data or status on the host bus and strobes the data from the controller into the host on the low to high transition (trailing edge).
26	Ground	GND	-	Ground
27	I	IORDY	I/O READY	Not used. Pulled up to Vcc through a 4.7k ohm resistor.

Pin	Pin Type	Signal Symbol	Signal Name	Signal Description
28	I	-CSEL	CABLE SELECT	This internally pulled up signal is used to configure the drives as the Primary or the Secondary device. When the pin is grounded, the device is configured as the Primary device. When the pin is open, the device is configured as a Secondary device.
29	I	-DACK	DMA ACKNOWLEDGE	Not used.
30	Ground	GND	-	Ground
31	O	INTRQ	INTERRUPT REQUEST	This is an interrupt request from the controller to the host, asking for service. This signal is the active high Interrupt Request to the host.
32	O	-IOS16	I/O SELECT 16	Not used.
33	I	A1	HOST ADDRESS 1	The address line A1 is used to select one of eight registers in the controller Task File.
34	I/O	-PDIAG		After an Executive diagnostic command to indicate that the Primary device has passed its diagnostics, this bi-directional open drain signal is asserted by the Secondary device.
35	I	A0	HOST ADDRESS 0	The address lines A0 and A2 are used to select one of eight registers in the controller Task File.
36	I	A2	HOST ADDRESS 2	
37	I	-CS1	HOST CHIP SELECT 1	The chip select signal used to select the Task File register.
38	I	-CS2	HOST CHIP SELECT 2	The chip select signal used to select the Alternate Status register and the Device Control register.
39	I/O	-DASP	DISK ACTIVE/ SECONDARY PRESENT	This input/output is the Disk Active/Secondary Present signal in the Primary/Secondary handshake protocol.
40	Ground	GND	-	Ground
41	-	V _{CC}	Supply Voltage	5V Power Supply
42	-	V _{CC}	Supply Voltage	5V Power Supply
43	Ground	GND	-	Ground
44	-	-	-	No Connection

SSD Control Block

The control block of the Zeus SSD is comprised of three integrated components:

- FPGA Controller
- RISC Microcontroller
- NAND SLC Flash Memory

FPGA Controller

The Field Programmable Gate Array (FPGA) controller Zeus SSD provides the ATA interface to the host, and the IDE interface to the local flash memory installed in the drive. The integrated DMA controller interfaces with system memory to facilitate data transfer between the host and the local flash memory in the SSD.

RISC Microcontroller

An integrated RISC microcontroller is responsible for initiating and controlling all activity within the Zeus ATA controller. The microcontroller features more than 1 Mbit of on-chip SRAM and a wide range of peripheral functions, with 8 Mbits of flash memory into a single compact 120-BGA package. The embedded microcontroller is a high-performance processor with a high-density instruction set with very low power consumption. In addition, a large number of internally banked registers provide very fast exception handling, making it ideal for real-time application control requirements. The 8-level priority-vectorized interrupt controller, together with the Peripheral Data Controller, significantly enhance the real-time performance of the SSD.

The flash memory controller architecture requires only minimal external component support. The flash controller can interface with a wide range of compatible flash memory devices from other manufacturers. Features of the flash memory controller include:

- Built-in 3.3V voltage regulator for flash memory supply
- Data transfer rates up to 40 MB/sec (controller to flash memory)
- True-IDE mode support
- Embedded ECC unit
- Wear-leveling and bad-block mapping software

NAND SLC Flash Memory

The local storage subsystem uses Single-Level Cell (SLC) NAND, non-volatile flash memory that has only two states and one bit of stored data. The SLC NAND flash control logic on the SSD is able to conserve energy when managing the electrical charge during operations.

ATA COMMANDS

This section provides information on the ATA commands supported by the Zeus SSD. The commands are issued to the ATA by loading the required registers in the command block with the supplied parameter, and then writing the command code to the register.

Standard ATA Commands

Table 8 lists each command along with its respective command code and registers accessed by the command. For detailed descriptions of the ATA commands, refer to the ATA-6

Table 8. Supported ATA Commands

Command	Command Code (Hex)	Feature Register	Sector Count Register	Sector Number Register	Cylinder High/Low Register	Drive/Head Number Register
CHECK POWER MODE	98h or E5h	No	Yes	No	No	Yes ^(a)
DOWNLOAD MICROCODE	92h	Yes	No	No	No	No
ERASE SECTOR	C0h	No	Yes	Yes	Yes	Yes ^(a)
EXECUTE DRIVE DIAGNOSTIC	90h	No	No	No	No	Yes ^(a)
FLUSH CACHE	E7h	TBD	TBD	TBD	TBD	TBD
FLUSH CACHE EXTENDED	EAh	TBD	TBD	TBD	TBD	TBD
FORMAT TRACK	50h	No	Yes	No	Yes	Yes ^(b)
IDENTIFY RESPONSE	ECh	Yes	No	No	No	Yes ^(a)
IDLE	97h, E3h	No	Y	No	No	Yes ^(a)
IDLE IMMEDIATE	95h, E1h	No	No	No	No	Yes ^(a)
INITIALIZE DRIVE PARAMETERS	91h	No	Yes	No	No	Yes ^(b)
NOP	00h	No	No	No	No	Yes ^(b)
READ BUFFER	E4h	No	No	No	No	No
READ DMA	C8h	No	Yes	Yes	Yes	Yes ^(b)
READ DMA EXTENDED	25h	No	Yes	Yes	Yes	Yes ^(b)
READ DMA QUEUED	C7h	No	Yes	Yes	Yes	Yes ^(b)
READ DMA QUEUED EXT	26h	No	Yes	Yes	Yes	Yes ^(b)
READ MULTIPLE	C4h	No	Yes	Yes	Yes	Yes ^(b)
READ MULTIPLE EXTENDED	29h	No	Yes	Yes	Yes	Yes ^(b)
READ SECTOR(S)	20h	No	Yes	Yes	Yes	Yes ^(b)
READ SECTOR(S) EXTENDED	24h	No	Yes	Yes	Yes	Yes ^(b)
READ VERIFY SECTOR(S)	40h	No	Yes	Yes	Yes	Yes ^(b)
READ VERIFY EXTENDED	42h	No	Yes	Yes	Yes	Yes ^(b)
RECALIBRATE	10h	No	No	No	No	Yes ^(a)

Command	Command Code (Hex)	Feature Register	Sector Count Register	Sector Number Register	Cylinder High/Low Register	Drive/Head Number Register
SECURITY DISABLE PASSWORD	F6h	No	No	No	No	Yes ^(a)
SECURITY ERASE PREPARE	F3h	No	No	No	No	Yes ^(a)
SECURITY ERASE UNIT	F4h	No	No	No	No	Yes ^(a)
SECURITY FREEZE LOCK	F5h	No	No	No	No	Yes ^(a)
SECURITY SET PASSWORD	F1h	No	No	No	No	Yes ^(a)
SECURITY UNLOCK	F2h	No	No	No	No	Yes ^(a)
SEEK	70h - 7Fh	No	No	Yes	Yes	Yes ^(b)
SET FEATURES	EFh	No	Yes	Yes	Yes	Yes ^(b)
SET MULTIPLE MODE	C6h	No	Yes	No	No	Yes ^(a)
SLEEP	E6h	No	No	No	No	Yes ^(a)
SMART	B0h	Yes	Yes	Yes	Yes	Yes ^(b)
STANDBY	96h or E2h	No	Yes	No	No	Yes ^(a)
STANDBY IMMEDIATE	94h or E0h	No	No	No	No	Yes ^(a)
WRITE BUFFER	E8h	No	Yes	Yes	Yes	Yes ^(b)
WRITE DMA	CAh	No	Yes	Yes	Yes	Yes ^(b)
WRITE DMA EXTENDED	35h	No	Yes	Yes	Yes	Yes ^(b)
WRITE DMA QUEUED	CCh	No	Yes	Yes	Yes	Yes ^(b)
WRITE DMA QUEUED EXT	36h	No	Yes	Yes	Yes	Yes ^(b)
WRITE MULTIPLE	C5h	No	Yes	Yes	Yes	Yes ^(b)
WRITE MULTIPLE EXTENDED	39h	No	Yes	Yes	Yes	Yes ^(b)
WRITE MULTIPLE FUA EXT	CEh	No	Yes	Yes	Yes	Yes ^(b)
WRITE SECTOR(S)	30h	No	Yes	Yes	Yes	Yes ^(b)
WRITE SECTOR(S) EXTENDED	34h	No	Yes	Yes	Yes	Yes ^(b)

Notes:

- (a) Only drive parameters are valid.
- (b) Drive and head parameters are valid.
- (c) Address to Drive 0 (zero). When executed, both drives (Primary and Secondary) execute this command.

Standard ATA Command Summary

This section provides a summary of each supported ATA command.

Check Power Mode (98h or E5h)

The Check Power Mode command allows the host to determine the current power mode of the device. The Check Power Mode command shall not cause the device to change power or affect the operation of the Standby timer.

Download Microcode (92h)

The command allows the host to alter the microcode of the device. The data transferred using the Download Microcode command is vendor-specific. All transfers are an integer multiple of the sector size. The size of the data transfer is determined by the contents of the LBA Low register and the Sector Count register. The LBA Low register will extend the Sector Count register to create a 16-bit sector count value. The LBA Low register will be the most significant eight bits and the Sector Count register will be the least significant eight bits. A value of zero in the LBA Low and Sector Count registers specify that no data is to be transferred. This allows transfer sizes from 0 bytes to 33,553,920 bytes, in 512-byte increments. The Features register will determine the effect of the Download Microcode command.

Erase Sector (C0h)

This command will pre-erase and condition the data sectors in advance.

Execute Drive Diagnostic (90h)

This command performs the internal diagnostic tests implemented by the controller.

Flush Cache (E7h)

This command is used by the host to request the device to flush the Write cache. If there is data in the Write cache, that data shall be written to the media. The command will not indicate completion until the data is flushed to the media or an error occurs. If the device supports more than 28 bits of addressing, this command shall attempt to flush all the data in the cache. If the Write cache is disabled or is not present, the device will indicate completion without error. The command is mandatory for devices not implementing the PACKET feature set.

Flush Cache Extended (EAh)

This command is used by the host to request the device to flush the Write cache. If there is data in the Write cache, that data shall be written to the media. The command will not indicate completion until the data is flushed to the media or an error occurs. If the Write cache is disabled or is not present, the device will indicate completion without error. This command is mandatory for devices that implement the 48-bit Address feature set.

Format Track (50h)

This command writes the desired head and cylinder of the selected drive with a vendor-unique data pattern (typically 00h or FFh). The drive accepts a buffer of data from the host to follow the command with the same protocol as the Write Sector(s) -30h command, although the information in the cache is not used.

Identify Response (ECh)

This command allows the host to receive parameter information from the drive.

Idle (97h, E3h)

This command will cause the drive to set BSY, enter the IDLE mode, clear BSY, and generate an interrupt. If the sector count is zero, the automatic power-down mode is disabled.

Idle Immediate (95h, E1h)

This command will cause the drive to set BSY, enter the IDLE (READ) mode, clear BSY, and generate an interrupt.

Initialize Drive Parameters (91h)

This command will enable the host to set the number of sectors per track and the number of heads per cylinder.

NOP (00h)

This command is mandatory for devices that implement the PACKET and TCQ feature sets. The device will respond with command aborted. For devices that implement the TCQ feature set, the subcommand 00h in the Feature field shall abort any outstanding queue. Subcommand codes 01h through FFh in the Feature field shall not affect the status of any outstanding queue.

Read Buffer (E4h)

This command is optional for devices that do not implement the PACKET feature set. The command will enable the host to read a 512-byte block of data. The Write Buffer (E8h) command should precede the Read Buffer (E4h) command, lest the data returned be indeterminate.

Read DMA (C8h)

This command is mandatory for devices that do not implement the PACKET feature set. The command will allow the host to read data using the DMA data transfer protocol.

Read DMA Ext (25h)

This command is mandatory for devices that implement the 48-bit Address feature set. The command will allow the host to read data using the DMA data transfer protocol.

Read DMA Queued (C7h)

This command is mandatory for devices that implement the TCQ feature set. The command is similar in function to the Read DMA (C8h) command. The device may release or execute the data transfer without performing a release if the data is ready to transfer.

Read DMA Queued Ext (26h)

This command is mandatory for devices that implement the TCQ and 48-bit feature sets. The command is similar in function to the Read DMA (C8h) command. The device may release or execute the data transfer without performing a release if the data is ready to transfer.

Read Multiple (C4h)

This command is similar to the Read Sector(s) -20h command. Interrupts are not generated on each sector, but on the transfer of a block that contains the number of sectors as defined by a Set Multiple Mode - C6h command.

Read Multiple Extended (29h)

This command is mandatory for all devices that implement the 48-bit Address feature set. The command will read the number of logical sectors specified in the Count field. The number of logical sectors determines the DRQ data block count, which in turn will determine the number of logical sectors that are to be transferred.

Read Sector(s) (20h)

This command will read from 1 to 256 sectors as specified in the Sector Count Register. A sector count of 0 (zero) requests 256 sectors. The transfer will begin at the sector specified in the Sector Number Register.

Read Sector(s) Extended (24h)

This command is mandatory for devices that implement the 48-bit Address feature set. This command will read from 1 to 256 to 65,536 logical sectors as specified in the Sector Count Register. A sector count of 0 (zero) will request 65,536 logical sectors. The transfer will begin at the sector specified in the LBA field.

Read/Verify Sector(s) (40h)

This command will verify one or more sectors by transferring data from the flash media to the data buffer and verifying the ECC is correct. The command is identical to the Read Sector(s) - 20h command except that DRQ is never set and no data is transferred to the host.

Read/Verify Extended (42h)

This command is mandatory for devices that implement the 48-bit Address feature set. The command is identical to the Read Sector(s) Extended (24) command, except that no data is transferred from the device to the host. The device will read the data stored in the media and verify that no errors exist.

Recalibrate (10h)

The SSD performs only the interface timing and register operations. When this command is issued, the SSD sets BSY and waits for an appropriate length of time, after which it clears BSY and issues an interrupt. When this command ends normally, the SSD is initialized.

Security Disable Password (F6h)

This command is mandatory for devices that implement the Security Mode feature set. The command will transfer 512 bytes of predefined data from the host. If the password selected by Word 0 matches the password that was previously saved by the device, the device shall disable Lock mode. The command will not change the Master password. The Master password is reactivated when a User password is set. The command will only complete successfully if the device is in Unlocked mode.

Security Erase Prepare (F3h)

This command is mandatory for devices that implement the Security Mode feature set. The command is issued immediately before the Security Erase Unit (F4h) command to enable device erasing and unlocking. The command prevents accidental loss of data on the device.

Security Erase Unit (F4h)

This command is mandatory for devices that implement the Security Mode feature set. The command will transfer 512 bytes of predefined data from the host. If the password does not match the password previously saved by the device, the device shall reject the command and abort it. When a Normal Erase mode is specified, the Security Erase Unit command shall write binary zeros to all user data areas. If the optional Enhanced Erase mode is specified, the device shall write predetermined data patterns to all user data areas; the current data is overwritten, including sectors that are no longer in use due to reallocation.

Security Freeze Lock (F5h)

This command is mandatory for devices that implement the Security Mode feature set. The command shall set the device to Frozen mode. Other commands that update the device Lock mode are aborted. Frozen mode can be disabled by a power-off or hardware reset. If the command is issued while the device is in Frozen mode, the command is executed and the device will remain in Frozen mode.

Security Set Password (F1h)

This command is mandatory for devices that implement the Security Mode feature set. The command will transfer 512 bytes of predefined data from the host. The data controls the function of this command, which in turn defines the interaction of the identifier and security level bits. The user can in turn set the Master or User passwords, and the security level of the device.

Security Unlock (F2h)

This command is mandatory for devices that implement the Security Mode feature set. The command will transfer 512 bytes of predefined data from the host. The data controls the function of this command, which in turn defines the interaction of the Identifier bit. If the Identifier bit is set to Master

and the current security level is high, the password is compared with the stored Master password. If the device is in maximum security level then the unlock shall be rejected. If the Identifier bit is set to User, then the device shall compare the supplied password with the stored User password. If the password comparison fails, the device shall abort the command and report a decrease in the incremental value in the unlock counter.

Seek (70h, 7Fh)

This command is effectively a NOP command to the SSD although it does perform a range check.

Set Features (EFh)

This command is used by the host to establish or select certain features supported by the drive. When the SSD receives this command, it sets BSY, checks the contents of the Features register, applies changes as necessary, clears BSY and generates an interrupt. If the value in the register does not represent a feature supported by the drive, the command is canceled with the Abort Error condition.

Set Multiple Mode (C6h)

This command enables the SSD to perform multiple Read and Write operations and establishes the block count for these commands.

Set Sleep Mode (99h or E6h)

This is the only command that allows the host to configure the drive for Sleep Mode. When the drive is set to Sleep Mode, the SSD clears the BSY line and issues an interrupt. The card enters Sleep Mode and the hardware or software must be reset to activate the drive.

Sleep (E6h)

This command is mandatory for devices that implement the Power Management feature set. The command will cause the device to enter Sleep mode. The device will not power-on in Sleep mode nor remain in Sleep mode following a reset sequence. The method used to deactivate Sleep mode is transport specific. The Power Management feature set is mandatory for devices that do not implement the PACKET Command set. This command is mandatory when power management is not implemented by the PACKET Command set device.

SMART (B0h)

See *SMART Support*.

Standby (96h or E2h)

This command will configure the drive for Standby Mode. If the Sector Count Register is a value other than 0H, an Auto Power Down is enabled and when the drive returns to Idle Mode, the timer starts a countdown. The time is set in the Sector Count Register.

Standby Immediate (94h or E0h)

This command will cause the SSD to set BSY, enter the Standby Mode, clear BSY, and return the interrupt immediately.

Write Buffer (E8h)

This command is optional for devices that implement the General feature set. This command allows the host to write the contents of one 512-byte block of data in the in the buffer of the device.

Write DMA (CAh)

This command is mandatory for devices that implement the General feature set. The command allows the host to write data using the DMA data transfer protocol.

Write DMA Ext (35h)

This command is mandatory for devices that implement the 48-bit Address feature set. The command allows the host to write data using the DMA data transfer protocol.

Write DMA Queued (CCh)

This command is mandatory for devices that implement the TCQ feature set. The command is similar to the Write DMA (CAh) command. The device may perform a release or may execute the data transfer without performing a release if the data is ready to transfer. If the device performs a release, the host should reselect the device using the SERVICE command. Once the data transfer has begun, the device shall not perform a release until the entire data transfer is complete.

Write DMA Queued Ext (38h)

This command is mandatory for devices that implement the TCQ and 48-bit Address feature sets. The command is similar to Write DMA Extended (35h). The device may perform a release or may execute the data transfer without performing a release if the data is ready to transfer. If the device performs a release, the host should reselect the device using the SERVICE command. Once the data transfer has begun, the device shall not perform a release until the entire data transfer is complete.

Write Multiple (C5h)

This command is similar to the Write Sector(s) - 30h command. Interrupts are not presented on each sector, but on the transfer of a block which contains the number of sectors defined by the Set Multiple Mode - C6h command.

Write Multiple Ext (39h)

This command is mandatory for devices that implement the 48-bit Address feature set. The command will write the number of logical sectors specified in the Count field. The command is similar to Write Sector(s) (30h). Interrupts are not presented on each sector, but on the transfer of blocks that contain the number of sectors defined by LBA mode.

Write Sector(s) (30h)

This command will write from 1 to 256 sectors as specified in the Sector Count Register. A sector count of 0 (zero) will request 256 sectors. The transfer begins at the sector specified in the Sector Number Register.

Write Sector(s) Ext (34h)

This command is mandatory for devices that implement the 48-bit Address feature set. The command will write 1 to 65,536 logical sectors as specified in the Sector Count Register. A sector count value of 0 will request 65,536 logical sectors.

SMART Support

Most SMART (Self-Monitoring, Analysis and Reporting Technology) commands are not relevant to solid state drives. Therefore, there is no data to provide to a host SMART command. Zeus drives do not abort these SMART host commands; the Zeus drives will report a "GOOD" status to all of these commands.

Identify Device Information

The Identify Device command enables the host to receive parameter information from the SSD. When the Identify Device command executes, the SSD sets the BSY bit, prepares to transfer the 256 words of SSD identification data to the host, sets the DRQ bit, clears the BSY bit, and then generates an interrupt. The host can then transfer the data by reading the Data register. All reserved bits or words are all zero. *Table 9* contains typical Identify Device Information for the Zeus SSD.

Identify Device Information Key	
F	Content of the word is fixed and does not change. For removable media devices, these values may change when the media is removed or changed.
V	Content of the word is variable and may change depending on the state of the device or the commands executed by the device.
X	Content of the word is vendor-specific and may be fixed or variable.
R	Content of the word is reserved and shall be 0 (zero).

Table 9. SSD Identify Device Information

Word	F/V	Description
0		General configuration bit-significant information
	F	15 0 = ATA Device
	F	14:8 Retired
	F	7 1 = Removable Media Device
	F	6 Obsolete
	X	5:3 Retired
	V	2 Response Incomplete
	F	1 Retired
F	0 Reserved	
1	V	Obsolete
2	V	Specific Configuration
3	F	Obsolete
4 -5	F	Retired
6	F	Obsolete
7 - 8	V	Reserved for assignment by the CompactFlash™ Association
9	F	Retired
10 - 19	F	Serial Number (20 ASCII Characters)
20 - 21	F	Retired
22	F	Obsolete
23 - 26	F	Firmware Revision (8 ASCII Characters)
27 - 46	F	Model Number (40 ASCII Characters)
47	X	15:8 80h
	R	7:0 00h = Reserved
	F	01h - FFh = Maximum number of sectors that shall be transferred per interrupt on READ/WRITE MULTIPLE Commands
48	F	Reserved
49		Capabilities
	R	15:14 Reserved for IDENTIFY PACKET DEVICE Command
	F	13 1 = Standby timer values as specified in this standard are supported 0 = Standby timer values shall be managed by the device
	R	12 Reserved for IDENTIFY PACKET DEVICE Command
F	11 1 = IORDY supported	

	F	10	0 = IORDY may be supported 1 = IORDY may be disabled
	R	9	1 = LBA supported
	R	8	1 = DMA supported
	X	7:0	Retired
50	F	Capabilities	
		15	Shall be cleared to zero
		14	Shall be set to one
		13 :2	Reserved
		1	Obsolete
		0	Shall be set to one to indicate a device-specific Standby Timer Value minimum
51 - 52	F		Obsolete
53	R	15:3	Reserved
	F	2	1 = The fields reported in Word 88 are valid 0 = The fields reported in Word 88 are invalid
	V	1	1 = The fields reported in Words 70:64 are valid 0 = The fields reported in Words 70:64 are invalid
		0	Obsolete
54 - 58	X		Obsolete
59	R	15:9	Reserved
	V	8	1 = Multiple Sector Setting is Valid
		7:0	xxh = Current setting for number of sectors that shall be transferred per interrupt on R/W MULTIPLE Command
60 - 61	F		Total Number of User-Addressable Sectors (LBA Mode only)
62	F		Obsolete
63	R	15:11	Reserved
	V	10	1 = Multiword DMA Mode 2 is selected 0 = Multiword DMA Mode 2 is not selected
	V	9	1 = Multiword DMA Mode 1 is selected 0 = Multiword DMA Mode 1 is not selected
	V	8	1 = Multiword DMA Mode 0 is selected 0 = Multiword DMA Mode 0 is not selected
	R	7:3	Reserved
	F	2	1 = Multiword DMA Mode 2 and below are supported

	F	1	1 = Multiword DMA Mode 1 and below are supported
	F	0	1 = Multiword DMA Mode 0 is supported
64		15:8	Reserved
	F	7:0	PIO Modes supported
65		Minimum Multiword DMA Transfer Cycle Per Word	
	F	15:0	Cycle Time in Nanoseconds
66		Manufacturer's Recommended Multi-word DMA Transfer Cycle	
	F	15:0	Cycle Time in Nanoseconds
67		Minimum PIO Transfer Cycle Time without Flow Control	
	F	15:0	Cycle Time in Nanoseconds
68		Minimum PIO Transfer Cycle Time with IORDY Flow Control	
	F	15:0	Cycle Time in Nanoseconds
69 - 70	R	Reserved (For Future Command Overlap and Queuing)	
71 - 74	R	Reserved for IDENTIFY PACKET DEVICE Command	
75	F	Queue Depth	
		15:5	Reserved
		4:0	Maximum Queue Depth - 1
76 - 79	R	Reserved	
80	F	Major Version Number	
		0000h or FFFFh = Device does not report version	
	F	15	Reserved
	F	14	Reserved for ATA/ATAPI-14
	F	13	Reserved for ATA/ATAPI-13
	F	12	Reserved for ATA/ATAPI-12
	F	11	Reserved for ATA/ATAPI-11
	F	10	Reserved for ATA/ATAPI-10
	F	9	Reserved for ATA/ATAPI-9
	F	8	Reserved for ATA/ATAPI-8
	F	7	Reserved for ATA/ATAPI-7
	F	6	1 = Supports ATA/ATAPI-6
	F	5	1 = Supports ATA/ATAPI-5
	F	4	1 = Supports ATA/ATAPI-4
	F	3	1 = Supports ATA-3
	X	2	Obsolete

	X	1	Obsolete
	F	0	Reserved
81	F		Minor Version Number 0000h or FFFFh = Device does not report version 0001h-FFFFh = Revision of ATA Standard guiding minor version number implementation
82	F		Command Set Supported
	X	15	Obsolete
	F	14	1 = NOP Command supported
	F	13	1 = READ BUFFER Command supported
	F	12	1 = WRITE BUFFER Command supported
	X	11	Obsolete
	F	10	1 = Host Protected Area Feature Set supported
	F	9	1 = DEVICE RESET Command supported
	F	8	1 = SERVICE Interrupt supported
	F	7	1 = RELEASE Interrupt supported
	F	6	1 = Look Ahead supported
	F	5	1 = Write Cache supported
	F	4	Shall be cleared to zero to indicate that the PACKET Command feature set is not supported
	F	3	1 = Power Management Feature Set supported (mandatory)
	F	2	1 = Removable Media Feature Set supported
	F	1	1 = Security Mode Feature Set supported
	F	0	1 = SMART Feature Set supported
83			Command Sets Supported
	F	15	Shall be cleared to zero
	F	14	Shall be set to one
	F	13	1 = FLUSH CACHE EXT Command supported
	F	12	1 = FLUSH CACHE Command supported (mandatory)
	F	11	1 = Device Configuration Overlay feature set supported
	F	10	1 = 48-Bit Address feature set supported
	F	9	1 = Automatic Acoustic Management feature set supported
	F	8	1 = SET MAX security extension supported
	F	7	See Address Offset Reserved Area Boot, INCITS TR27:2001
	F	6	1 = SET FEATURES subcommand required to spin-up after power-up

	F	5	1 = Power-Up in Standby feature set supported
	F	4	1 = Removable Media Status Notification feature set supported
	F	3	1 = Advanced Power Management feature set supported
	F	2	1 = CFA feature set supported
	F	1	1 = READ/WRITE DMA QUEUED supported
	F	0	1 = DOWNLOAD MICROCODE Command supported
84			Command Set/Feature Supported Extension
	F	15	Shall be cleared to zero
	F	14	Shall be set to one
	F	13:6	Reserved
	F	5	1 = General Purpose Logging feature set supported
	F	4	Reserved
	F	3	1 = Media Card Pass Through Command feature set supported
	F	2	1 = Media Serial Number supported
	F	1	1 = SMART Self-Test supported
	F	0	1 = SMART Error-Logging supported
85			Command Set/Feature Enabled
	X	15	Obsolete
	F	14	1 = NOP Command enabled
	F	13	1 = READ BUFFER Command enabled
	F	12	1 = WRITE BUFFER Command enabled
	X	11	Obsolete
	V	10	1 = Host Protected Area feature set enabled
	F	9	1 = DEVICE RESET Command enabled
	V	8	1 = SERVICE Interrupt enabled
	V	7	1 = RELEASE Interrupt enabled
	V	6	1 = Look Ahead enabled
	V	5	1 = Write Cache enabled
	F	4	Shall be cleared to zero to indicate that the PACKET Command feature set is not supported.
	F	3	1 = Power Management Feature Set enabled
	F	2	1 = Removable Media Feature Set enabled
	V	1	1 = Security Mode Feature Set enabled
	V	0	1 = SMART Feature Set enabled

86	Command Set/Feature Enabled		
	F	15:14	Reserved
	F	13	1 = FLUSH CACHE EXT Command supported
	F	12	1 = FLUSH CACHE Command supported
	F	11	1 = Device Configuration Overlay supported
	F	10	1 = 48-Bit Address features set supported
	V	9	1 = Automatic Acoustic Management feature set enabled
	F	8	1 = SET MAX security extension enabled by SET MAX SET PASSWORD
	F	7	See Address Offset Reserved Area Boot, INCITS TR27:2001
	F	6	1 = SET FEATURES subcommand required to spin-up after power-up
	V	5	1 = Power-Up in Standby feature set enabled
	V	4	1 = Removable Media Status Notification feature set enabled
	V	3	1 = Advanced Power Management feature set enabled
	F	2	1 = CFA feature set supported
F	1	1 = READ/WRITE DMA QUEUED Command supported	
F	0	1 = DOWNLOAD MICROCODE Command supported	
87	Command Set/Feature Enabled		
	F	15	Shall be cleared to zero
	F	14	Shall be set to one
	F	13:6	Reserved
	F	5	General Purpose Logging feature set supported
	V	4	Reserved
	V	3	1 = Media Card Pass Through Command feature set supported
	V	2	1 = Media Serial Number is valid
	F	1	1 = SMART Self-Test supported
F	0	1 = SMART Error-Logging supported	
88	Ultra DMA Modes		
	F	15:14	Reserved
	V	13	1 = Ultra DMA Mode 5 is selected 0 = Ultra DMA Mode 5 is not selected
	V	12	1 = Ultra DMA Mode 4 is selected 0 = Ultra DMA Mode 4 is not selected
	V	11	1 = Ultra DMA Mode 3 is selected 0 = Ultra DMA Mode 3 is not selected

	V	10	1 = Ultra DMA Mode 2 is selected 0 = Ultra DMA Mode 2 is not selected
	V	9	1 = Ultra DMA Mode 1 is selected 0 = Ultra DMA Mode 1 is not selected
	V	8	1 = Ultra DMA Mode 0 is selected 0 = Ultra DMA Mode 0 is not selected
	F	7:6	Reserved
	F	5	1 = Ultra DMA Mode 5 and below are supported
	F	4	1 = Ultra DMA Mode 4 and below are supported
	F	3	1 = Ultra DMA Mode 3 and below are supported
	F	2	1 = Ultra DMA Mode 2 and below are supported
	F	1	1 = Ultra DMA Mode 1 and below are supported
	F	0	1 = Ultra DMA Mode 0 is supported
89	F		Time required for Security Erase Unit completion
90	F		Time required for Enhanced Security Erase completion
91	V		Current Advanced Power Management value
92	V		Master Password Revision Code
93			Hardware Reset Result. The contents of bits (12:0) of this word shall change only during the execution of a hardware reset. See 7.16.7.41 for more information.
	F	15	Shall be cleared to zero.
	F	14	Shall be set to one.
	V	13	1 = Device detected CBLID - above V_{IH} 0 = Device detected CBLID - below V_{IL}
		12:8	Device 1 Hardware Reset Result. Device 0 shall clear these bits to zero. Device 1 shall set these bits as follows:
	F	12	Reserved
	V		11 0 = Device 1 did not assert PDIAG- 1 = Device 1 asserted PDIAG-
	V	10:9	These bits indicate how Device 1 determined the device number. 00 = Reserved 01 = A jumper was used. 10 = The CSEL signal was used. 11 = Some other method was used/method unknown
		8	Shall be set to one.

		7:0	Device 0 Hardware Reset Result. Device 1 shall clear these bits to zero. Device 0 shall set these bits as follows: 7 Reserved 6 0 = Device 0 does not respond when Device 1 is selected. 1 = Device 0 responds when Device 1 is selected. 5 0 = Device 0 did not detect the assertion of DASP-. 1 = Device 0 detected the assertion of DASP-. 4 0 = Device 0 did not detect the assertion of PDIAG-. 1 = Device 0 did detect the assertion of PDIAG-. 3 0 = Device 0 failed diagnostics. 1 = Device 0 passed diagnostics.
	F		
	F		
	V		
	V		
	V		
	V	2:1	These bits indicate how Device 0 determined the device number. 00 = Reserved 01 = A jumper was used. 10 = The CSEL signal was used. 11 = Some other method was used/method unknown
	F	0	Shall be set to one.
94	F	15:8	Vendor's recommended acoustic management value.
		7:0	Current automatic acoustic management value.
95 - 99	F		Reserved
100-103	V		Total Number of User-Addressable Sectors for 48-bit Address feature set.
104-126	V		Reserved
127			Removable Media Status Notification Feature Set Support
	F	15:2	Reserved
	F	1:0	00 = Removable Media Status Notification feature set not supported 01 = Removable Media Status Notification feature supported 10 = Reserved 11 = Reserved
128			Security Status
	F	15:9	Reserved
	V	8	Security Level: 0 = High, 1 = Maximum
	F	7:6	Reserved
	F	5	1 = Enhanced Security Erase supported

	V	4	1 = Security Count Expired
	V	3	1 = Security Frozen
	V	2	1 = Security Locked
	V	1	1 = Security Enabled
	F	0	1 = Security Supported
129 - 159	X	Vendor Specific	
160		CFA Power Mode 1	
	F	15	Word 160 supported
	F	14	Reserved
	F	13	CFA Power Mode 1 is required for one or more commands implemented by the device
	V	12	CFA Power Mode 1 disabled
	F	11:0	Maximum Current in mA
161 - 175	R	Reserved for assignment by the CompactFlash™ Association	
176 - 205	V	Current Media Serial Number (60 ASCII Characters)	
206-254	F	Reserved	
255	X	Integrity Word	
		15:8	Checksum
		7:0	Signature

Vendor-Specific ATA Commands

As with standard ATA commands, the software requirements and syntax of the vendor-specific ATA commands the host issues to the Zeus SSD are issued to the ATA by loading the required registers in the command block with the supplied parameters, and then writing the command code to the register.

For additional information on proprietary STEC ATA commands, contact your STEC representative. The contact information is provided in *Contact and Ordering Information* section at the end of this document.

Sanitize Erase/Fill

Zeus SSDs offer optional destructive and non-destructive sanitization (purge) features. Non-destructive security erase removes the data from the drive, then overwrites (fills) each addressable block of memory with a predetermined pattern, as specified by the sanitization specification, such as DoD 5220.22M, to which the SSD complies. The destructive security erase feature removes the data, and then destroys the flash media, making the SSD totally unusable and data retrieval impossible. The non-destructive and patent-pending destructive security erase algorithms monitor and confirm completion of the sanitization process.

Both security erase features support Low Power and Fast Erase options. The Low Power option accesses each addressable memory block sequentially to conserve power. The Fast Erase option accesses all addressable blocks simultaneously, forgoing power conservation for speed.

Sanitization Standards

Zeus SSDs comply with the sanitization requirements described in *Table 10*.

Table 10. Sanitize Standards Compliance

Specification	Document Description/Comment
USA DoD 5220.22-M	National Industrial Security Program Operation Manual (NISOM), January 1995. Specifies the sanitization process for various media types in order to be considered declassified.
NSA 130-2	Media Declassification and Destruction Manual, November 2000. Specifies the sanitization procedure for semiconductor memory devices.
AR 380-19	Information Systems Security (ISS), 27 March 1998. Provides the security requirements for systems processing Special Access Program (SAP) information and describes the ISS policy as it applies to security in hardware, software procedures, telecommunication, personal use, physical environment, networks and firmware. Section VII, Automated Information System Media, Section 2-20, describes cleaning, purging, declassifying and destroying media. Appendix F-2 describes how to sanitize flash memory.
AFSSI 5020	USA Air Force System Security, Instruction (AFSSI) 5020, 20 August 1996. Specifies the sanitization procedure for confidential media. Chapter 5, Semiconductor Devices, describes the security procedure for all types of semiconductor media. Paragraph 5.3 describes the procedure for sanitizing flash memory.
Navso P-5239-26	Information Systems Security (INFOSEC) Program Guidelines. Provides policy, guidelines, and procedures for clearing and purging computer system memory and other storage media for release outside of and for reuse within controlled environments. It pertains to both classified and sensitive unclassified information. Implements DOD 5200.28-M and CSC-STD-005-85. Chapter 3 describes the cleaning and purging of data storage media.

PHYSICAL CHARACTERISTICS

General Physical Characteristics

Materials

All acceptable enclosure materials are HB rated or higher if approved by safety agencies (UL, CSA, TUV, etc.). All printed circuit boards shall have a flammability rating of UL94V-0.

Drive Assembly Weight

The weight of a Zeus SSD varies according to the specific set of design characteristics of the drive. A standard 2.5-inch Zeus SSD weighs less than 0.4 kg. (0.88 lbs.). The following characteristics determine the exact weight of a drive:

- Storage capacity
- IC stacking technology (if used)
- Flash controller/memory configuration
- Form factor

Storage Capacities

The following table provides a representative list of the various capacities in which the Zeus SSDs are available, along with associated LBA (Logical Bit Addressing) and CHS (Cylinder, Head, Sector) information. The *CHS Capacity* is expressed as *User-Addressable LBA* sectors.

Table 11. Zeus ATA SSD Capacities

Capacity (Unformatted)	Logical Bit Addressing (LBA Data)	Cylinder, Head, Sector (CHS) Data			
	User-Addressable LBA Sectors	CHS Capacity	Logical Cylinders	Logical Heads	Logical Sectors
8GB	16,090,112	16,089,696	15,962	16	63
16GB	32,196,608	16,514,064	16,383	16	63
32GB	64,408,576	16,514,064	16,383	16	63
64GB	121,717,680	16,514,064	16,383	16	63

Exterior Dimensions

Zeus SSD internal components are housed in precision machined aluminum alloy enclosures. *Table 12* lists the exterior dimensions of 2.5-inch form factor drive. The 2.5-inch drive assembly is illustrated in *Figure 4*.

Table 12. 2.5 Drive Assembly Dimensions

Dimension	Millimeters (Inches)
Height	9.5mm (0.374 in)
Width	69.85mm (2.754 in)
Length (Maximum)	100.20mm (3.94 in)

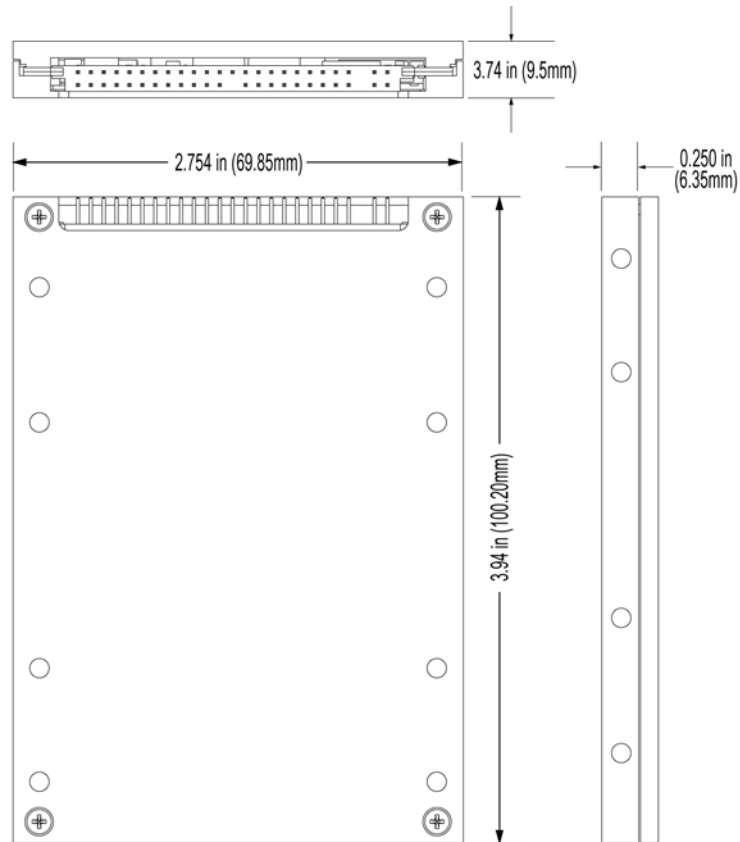

Figure 4. Zeus 2.5-inch ATA SSD Exterior Dimensions

ATA Connector Location

Figure 5 illustrates the relative location of the ATA connector on the underside of the drive.

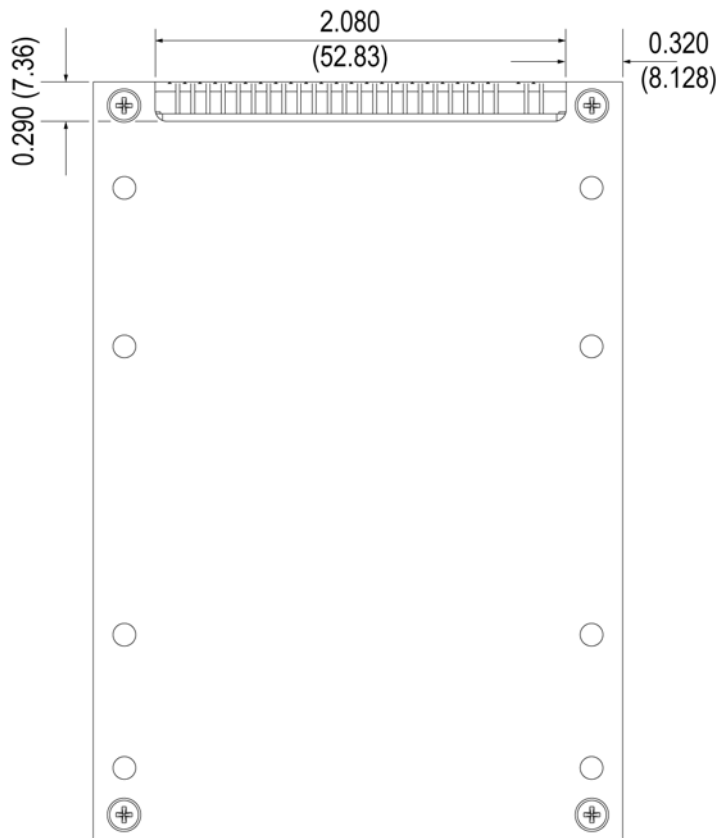

Figure 5. ATA Connector Location

ENVIRONMENTAL CHARACTERISTICS

Overview

Zeus ATA SSDs are subjected to a series of environmental tests to validate the portability and suitability for operation in harsh and mobile conditions. The SSDs operate without degradation within the ambient temperature, relative humidity and altitude ranges as specified in the following sections.

Operating Temperatures

The SSDs (all models) operate without degradation within the ambient temperature ranges specified in *Table 13*.

Table 13. Operating Temperatures

Operating Temperature	Centigrade (°C)		Fahrenheit (°F)	
	Minimum	Maximum	Minimum	Maximum
Commercial	0	70	32	158
Industrial	-40	85	-40	185

Operating Requirements

Note: For operating requirements, the ambient air temperature is that of the inlet air for the equipment. Please see *Table 14*.

Table 14. Operating Requirements

Operating Requirement	
Case Temperature	0° C to 70° C
Maximum Temperature Gradient	30° C/h
Short Duration Temperature	82° C for 2h
Relative Humidity (Non-condensing)	10% to 90%
Maximum Wet Bulb Temperature	20° C

Non-Operating Requirements

Note: Non-operating requirements include shipment and storage environments. See Table 15.

Table 15. Non-Operating Requirements

Non-Operating Requirements	
Temperature Range	-55° C to 95° C
Maximum Temperature Gradient	30° C/h
Short Duration Temperature	82°C for 2h
Relative Humidity Range (Non-condensing)	5% to 95%
Maximum Wet Bulb Temperature	38°C
Maximum Relative Humidity Gradient	20%/h

Relative Humidity

Table 16 lists the operating and non-operating relative humidity criteria for the Zeus SSD.

Table 16. Relative Humidity Criteria

Operating	Criteria
Relative Humidity Range (Non-Condensing)	5% to 95%
Maximum Wet Bulb Temperature	29°C
Maximum Relative Humidity Gradient	20%/h
Non-Operating	Criteria
Relative Humidity Range (Non-Condensing)	5% to 95%
Maximum Wet Bulb Temperature	38°C
Maximum Relative Humidity Gradient	20%/h

Altitude Parameters

Operating and non-operating altitude parameters for the Zeus SSD are the same, with a low-altitude limit of -1,000 ft. (-304.80m) and a high-altitude limit of 80,000 ft. (24,384m). Altitude is referenced to sea-level on a standard day at 58.64°F (19.8°C)

Table 17. Operating and Non-Operating Altitudes

Altitude Parameter	Criteria
Low Altitude Limit	-1,000 ft. (-304.80m)
High Altitude Limit	80,000 ft. (24,384m)

Restriction of Hazardous Materials

STEC Inc., has adopted the RoHS Directive, also known as the Restriction of Hazardous Substances directive. Zeus SSDs are compliant with the European Parliament and Council Directive, i.e., assembled with Pb-free or lead-free components.

Shock and Vibration

In determining the initial baseline for shock and vibration test levels, the SSD is exposed to increasingly harsh levels of stress until the failure levels of the drive is established. The tests were then repeated using established stress levels to verify that the SSD would meet these specifications consistently. The process established the shock and vibration levels that have been used in subsequent shock and vibration testing.

Failure Criteria

Test failures are defined as:

- Any single hard error (unrecoverable error)
- Damage that renders the product inoperable
- Failure to meet performance specifications

Random Vibration

For random vibration, the device will perform without errors after being tested at 15 min/axis on three axes (X, Y and Z). During the operational vibration, the drive will be performing continuous reads. The SSD also adheres to 16.3G RMS per MIL-STD-810F (Random, 20Hz to 2,000Hz; 3 vibration axes). Vibration levels are listed in *Table 18*. In addition to the previously mentioned *Failure Criteria*, during the operating random vibration, the transfer rate of the drive should not degrade by more than 10%.

Table 18. Random Vibration Levels

Parameter	Value	Condition
Operating Vibration	16.3	G, RMS, 20Hz to 2,000Hz, 1 Hour Duration, 3 Axes

Shock

The SSD is shock-tested in accordance with MIL-STD-810F and will operate as specified, without degradation, when subjected to the following as shown in *Table 19*.

Table 19. Shock Test Results

Test Condition	Result
Three 50G shocks (peak value, 11 ms duration, half-sine waveform) along the X, Y and Z axes.	1,500G Operating Shock

Drop Testing

The SSD will withstand three (3) drops on a concrete floor from 60 inches(1.524m) on each of six (6) axes, +/-X, +/-Y, and +/-Z, without any damage when packaged.

Conformal Coating

As an option, the user can choose to have the factory apply a conformal coating to the electronic circuitry of the SSD to further protect against moisture, dust, chemicals and temperature extremes. The material coating may actually reduce the effects of mechanical stress and vibration on the circuitry.

The coating material should achieve an approximate thickness of between 50 and 100 micrometers after curing. A thicker coating may be required when liquid water is present due to microscopic pinhole formation when the coating material thins on the sharp edges of the components. Enough material is applied to completely cover the components to a depth equal to or greater than the highest metallic conductor on the PCB.

The conformal coating physical characteristics meet IPC-CC-830 regulations for the qualification and performance of electrical insulating compounds for printed wiring assemblies. The workmanship standard is in accordance with IPC-A-610, Section 10.5.2.

The HumiSeal 1B31 Acrylic or equivalent coating is applied to both sides of the PCB, and masks the connector body and pins, and some component topsides.

INSTALLATION

System Requirements



There is a risk of electrocution! Use extreme caution when handling the solid state drive and while connecting it to a power source. Observe all applicable electrical safety rules while installing the solid state drive. Make sure to read and thoroughly understand this section before attempting to install the drive.

The SSD can be installed in any system running an operating system that supports the ATA (IDE) bus specification standard. No modifications to the operating system are required. The Zeus SSD supports all ATA and ATAPI devices, including CDs, DVDs, tape backup devices, high-capacity removable devices, Zip drives, and CDRWs.

If the drive is not recognized by the operating system, make sure the most recent drivers for the host adapter are installed. If the drive is connected to the motherboard, the drivers are provided by the motherboard manufacturer. If the drive is connected to a PCI card, contact the PCI card manufacturer.

Before installing the Zeus SSD in the system, make sure the following items are available:

- Phillips screwdriver
- Six M3 UNC machine screws
- ATA (IDE) bus interface cable (1 meter (39 inches) maximum length. (See *Table 20* for the cabling requirements.)
- Mounting hardware (as required)
- A computer with an ATA connector on the motherboard or an installed ATA host adapter
- A 5.0V power source (4-pin connector)

Table 20. ATA (IDE) Cable Requirements

ATA (IDE) Interface	Operating Mode
44-pin; 44 conductor	PIO modes 0, 1, 2, 3 and 4 Ultra DMA Modes 0 - 5
44-pin, 80-conductor	Ultra DMA Modes 0 - 5

Drive Configuration

The drive must be configured to operate as either the *Primary (Device 0)* or *Secondary (Device 1)* IDE device. The Primary/Secondary setting represents the order of electronic devices on an IDE channel. If the Zeus SSD is the only ATA (IDE) drive installed in the system, the drive is configured as the primary device. If two drives are installed in the machine, one device must be configured as the primary and the remaining device as the secondary. Jumper pins located at the rear of the Zeus SSD allow you to configure the drive as either the primary or the secondary device.



If the host system has multiple drives, it may be necessary to configure disk storage using a Primary/Secondary (Device 0/ Device 1) setup. To accomplish this, boot the computer using IDE HDD Auto Detection available in the CMOS Setup.

Jumper Pins

Zeus SSDs conforming to the 2.5-inch form factor use a 44-pin ATA bus/DC power combination connector. To configure the SSD as either the Primary or Secondary device, place a jumper across the appropriate pins (A - D) as illustrated in *Figure 6*.

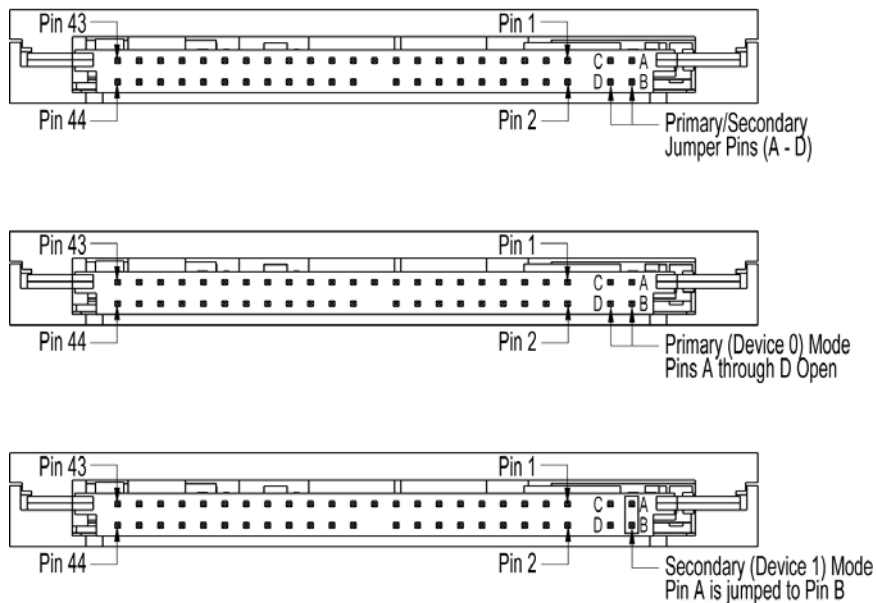

Figure 6. Primary/Secondary Setting for 2.5-inch Zeus ATA SSDs

Drive Orientation

The Zeus SSD can be installed in any number of orientations within the enclosure. The drive will operate and meet all the requirements as outlined in this specification regardless of the mounting orientation. *See Figure 7.*

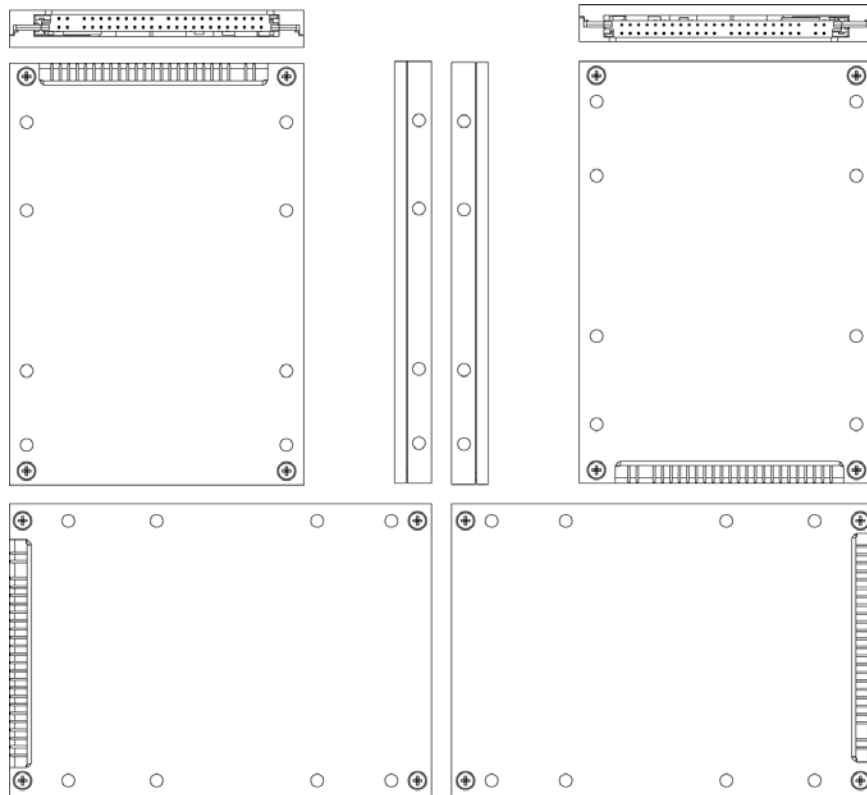

Figure 7. Possible Drive Orientations

Cooling Requirements

If necessary to maintain the required operating temperature range, the host enclosure may remove heat by conduction, convection, or other forced air flow. The suggested air flow patterns are shown in *Figure 8*.

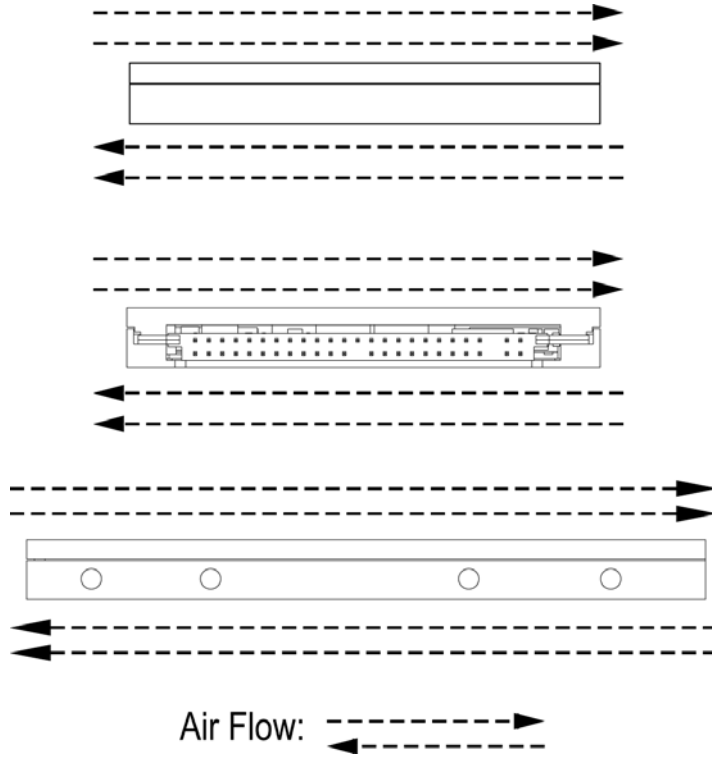

Figure 8. Suggested Air Flow Patterns for Cooling

Installation Dimensions

Figure 9 shows the exterior dimensions of the 2.5-inch form factor with the relative locations of the mounting holes.

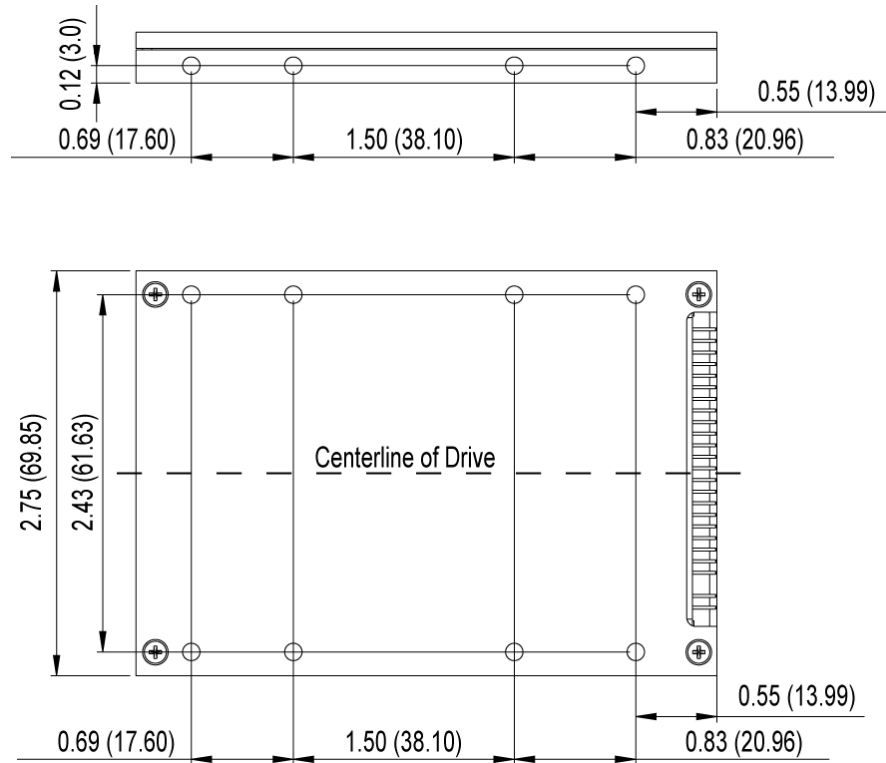

Figure 9. Exterior Mounting Specifications

Mounting Hole Locations

Figure 10 provides an overview of the locations of the mounting holes for the 2.5-inch form factor SSD. Careful attention should be made to the length of the mounting screws and recommended torque to prevent damage to the enclosure.

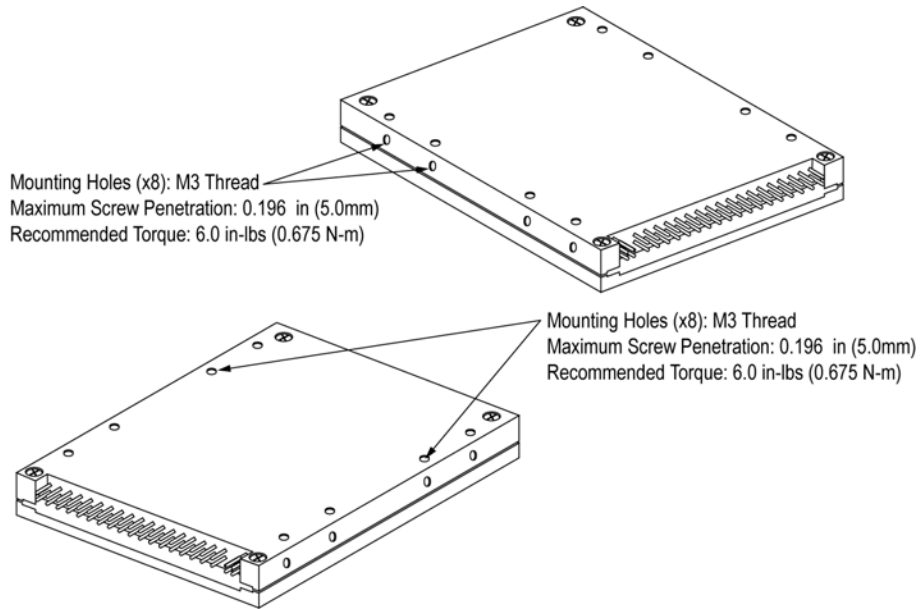

Figure 10. Zeus 2.5-Inch Mounting Hole Locations

Drive Installation



ATA standards require 80-conductor cables to be used for Ultra DMA modes 3 through 5. The length of the cable shall not exceed 18 inches (457.2mm).



Electrostatic Discharge or ESD can seriously damage the electronic components of the host system and solid state drive. It is very important to discharge any static electricity before you begin the installation procedure. You can touch an unpainted, grounded metallic surface to discharge any static charges that may be present on your body or clothing. As an alternative, you can also use an ESD protective wrist strap. You can minimize the possibility of damage due to ESD by avoiding physical contact with the electronic components.

To install the Zeus ATA SSD in a personal computer (PC) or host system:

- 1 Power down the computer/host system and remove the access cover.
- 2 Configure the Zeus SSD as the primary or secondary device according to the instructions under "Jumper Pins" in the previous section.
- 3 Connect one end of an ATA (IDE) cable to the Zeus SSD and the other end of the cable to the IDE adapter on the host. Orient the cable so that pin 1 on the Zeus SSD connects to pin 1 on the host adapter.
- 4 Position the Zeus SSD in an unused drive bay and secure it in place using M3 machine screws. Apply sufficient torque to ensure that the drive is secure.

Note: Be aware of the depth of the mounting holes. The maximum penetration depth of the drive's mounting holes is indicated in *Figure 8* on page 41. You may mount the drive using the side or bottom mounting holes. It is recommended that you secure the drive with at least four screws. To avoid damaging the drive, consider the thickness of the mounting surface when deciding on the screw length to use.

- 5 Replace the access cover and power on the computer.



The SSD receives a low-level format at the factory. The SSD must be partitioned and high-level formatted by the user.

Grounding Requirements

No special grounding circuitry is required. Pins 2, 19, 22, 24, 26, 30, 40 and 43 serve as Ground (GND) signals of the ATA (IDE) connector configuration. The signal and chassis grounds are not connected together in the drive. The user should use the maximum surface contact area when connecting the drive to the chassis ground to ensure minimal electromagnetic (EM) emissions.

Operating System Specifications

The SSD is ready for use after it is installed in the host system. The SSD does not require special driver installation, adjustments or modifications. The Zeus SSDs are compatible with Microsoft Windows® and other non-Microsoft operating systems. The SSDs are low-level formatted at the factory. However, the SSDs must be partitioned and high-level formatted.

Microsoft OS Compatibility

The Zeus SSDs are fully compatible with the following Microsoft operating systems, using the native drives supplied with the OS:

- Windows 2000, Service Packs 2, 3 and 4
- Windows 2000 Server, Advanced Server
- Windows XP Home and Windows XP Professional, Service Packs 1 and 2
- Windows XP, 64-Bit Extended
- Windows 2003 Standard, Enterprise, 64-bit, Web, Datacenter, Small Business Server
- MS-DOS
- Windows Pre-boot Environment (WinPE)

The drives are compatible with the current version of the MS-DOS real-mode drivers bundled with any of the Microsoft operating systems for reading files from optical media.

Non-Microsoft OS Compatibility

The drives are fully compatible with the following operating systems, using the native drivers supplied with the OS:

- Red Hat Linux 2.1
- Red Hat Linux 3.0
- DRMK DOS

System POST, Boot and Resume Times

The drive's effect on the time required for the system to POST, boot and resume under Microsoft Windows XP is minimized. Device implementation will target minimum impact to such. The drives also comply with the Microsoft Fast Boot/Fast Resume Requirement, which is ≤ 2.5 s for Resume from Standby (S3), ≤ 20 s for Resume from Hibernation (S4).

NAND Flash Support

The device will support multiple mutually agreed upon and approved NAND flash memory vendors prior to release to manufacturing for proposed capacities in the design without changes to the hardware or firmware. STEC Inc. develops firmware to support a wide range of NAND flash versions and vendors. Please contact STEC Inc. for a list of supported flash and flash vendors.

Diagnostic Software

The computer manufacturer is responsible for providing any diagnostic software or diagnostic utilities.

REGULATORY COMPLIANCE

Marks, Approvals and Documentation

Zeus SSDs may have the following marks, approvals and documentation as outlined in *Table 22*.

Table 21. Regulatory Marks and Documentation

Mark or Approval	Documentation	Mark
UL	Electrical Equipment sold in the United States of America shall comply with the requirements of UL 1950 or other applicable UL standard and be marked (UL or other NRTL marking) accordingly. STEC Inc. will provide the Declaration of Conformity (DoC). UL Notice of Acceptance letter (with corresponding file number) indicating compliance with UL 60950-1.	Yes
CE	Electrical equipment sold in the European Economic Area (EEA) will comply with the requirements of CAN/CSA-C22.2 No. 60950-1-03 and have the CE mark accordingly.	Yes
CSA (or ULc)	Electrical equipment sold in Canada will comply with the requirements of CAN/CSA-C22.2 No. 959-M98 or other applicable Canadian Standards Association standard and be marked (CSA, cUL) accordingly.	Yes
EU	In the European Community (European Union or EU), Information Technology Equipment (ITE) is governed within the EC (EU) by Directive 73/23/ECC ("Low Voltage Directive") for Product Safety and 89/336/EEC - Harmonized standards ("EMC Directive") EN55022, 1998 and EN55024, 1998 for Emissions and Immunity, and all applicable amendments. EC (EU) members are bound by its requirements. Equipment may demonstrate compliance with the directive by being approved to a recognized standard by an EC (EU) recognized agency such as TUV or VDE and a signed Declaration of Conformity, plus the CE mark on the device.	Yes
TUV/SEMKO/UL/ etc.	Germany, being part of the EC, is bound by the Low Voltage and EMC Directive. In addition, Germany's Equipment Safety Law requires that equipment will be "... in accordance with the generally recognized rules of technology and the work safety and accident prevention regulations..." Equipment may demonstrate compliance with the directive by being approved to a recognized standard by an EC (EU) recognized agency such as TUV or VDE. STEC Inc. will provide CB Certificate and Test Report with the supporting Type Certificate (e.g., TUV Certificate, from the Agency that approved the CB Test Report)	No
MIC (Korea)	Certificate (with certification number)	Yes
BSMI (Taiwan)	Certificate (with corresponding applicant code number)	Yes
VCCI (Japan)	Certificate or Declaration of Conformity. Self declaration that the product has been evaluated in a VCCI compliant lab is sufficient.	Yes
C-TICK (Australia)	Declaration of Conformity (DoC) (with supplier code number) and a Letter of Authorization from supplier giving Dell permission to import and sell the product in Australia using STEC's C-TICK.	
FCC	Declaration of Conformity	Yes

CB Certificate and CB Report

STEC Inc. will provide a complete CB Report. These documents will include the current and voltage ratings, and prove compliance with the currently applicable versions of IEC 60950-1:2001, Safety of Information Technology Equipment, including all national deviations.

STEC Inc. will also provide the EMC test report indicating compliance with the currently applicable versions of:

- EN-55022:1998 (Emissions)
- EN-55024:1998 (Immunity)
- FCC 47CFR Part 15 Class B

Declaration of Conformity

The Declaration of Conformity (DoC) will contain the following:

- Product type and model number
- Marks and countries (e.g. CE, FCC, C-Tick)
- The appropriate technical statement(s) required by the respective regulatory agencies
- STEC Inc. name and address
- STEC Inc. signature
- List of all applicable standards to which the drive conforms

Radio Frequency Emissions

The Zeus SSD has passed radiated emissions testing (10 meter chamber) with a minimum margin of 4dB below the EN55022 radiated emissions limits in all applicable customer platforms, without any required changes to the system platforms.

Emissions testing in a 3 meter chamber for over 1GHz per the FCC limit for Class B was performed up to 2GHz. The -4dB margin, relative to the FCC Class B limit, is a customer requirement.

In preparation for the new CISPR 22 standard change that may go into effect in the year 2007, the customer requires all drives to pass EMI tests up to the higher frequency of either 6GHz or the fifth harmonic of the highest signal on the drive. This requirement is applicable to all products being qualified after this version is released. The specification limits are listed in *Table 23*.

Table 22. *EMI Specification Limits*

Class B	1 to 3 GHz is 50dB (uV/m) @ 3 m
Class B	3 to 6 GHz is 54dB (uV/m) @ 3 m

Radio Frequency Immunity Requirements

This specification is targeted as part of the design for quality and reliability expectations and is not part of the regulatory requirements. The SSDs meet the following radio frequency immunity requirements:

- 3 V/m over frequency range of 80 MHz to 1 GHz
- The signal will be amplitude modulated with a 1KHz sine wave to a depth of 80%
- Failure criteria: More than 10% throughput degradation

EMI Test Site Correlation

STEC Inc. will only use EMI test sites that are currently correlated with the customer's test facilities. STEC Inc. will contact the customer's engineering staff for the list of approved laboratories.

Verification Samples

STEC Inc. will submit the three worst-case drives used to obtain the emissions test data previously obtained from the customer's test facilities for verification testing. The Regulator Engineer will use these drive samples, and others among those submitted for qualification, for emissions verification in the customer's systems.

Verification Testing

Verification testing will be performed by the customer's Compliance Peripheral Group.

Electrostatic Discharge (ESD)

The SSD will meet the ESD limits specified in the 61000-4-2 guidelines and the customer's enhanced ESD procedure. The specification will determine whether the contact or air discharge method should be used. Performance degradation is defined as a decreased throughput rate. No data error are allowed. *Table 23* lists the ESD requirements.

Table 23. ESD Requirements

Climatic Conditions		
Ambient Temperature	15°C to 35°C	
Relative Humidity	30% to 60%	
Atmospheric Pressure	86kPa (860 mbar) to 106 kPa (1060 mbar)	
Voltage Level	Discharge Type	Pass/Fail Performance Criteria
+/-2 kV	Contact	A
+/-4 kV	Contact	B
+/- 6 kV	Contact	B
+/-8 kV	Contact	C
+/-2 kV	Air	A
+/-4 kV	Air	A
+/-8 kV	Air	B
+/-12 kV	Air	B
+/-15 kV	Air	C

Acceptance Criteria Definitions

The following table lists the acceptance criteria definitions for the ESD limits.

Table 24. Acceptance Criteria Definitions

A	The apparatus will continue to operate as intended, i.e., normal unit operation with no degradation of performance.
B	The apparatus will continue to operate as intended after completion of the test. However, during the test, some degradation of performance is allowed provided there is no data loss or operator intervention to restore apparatus function.
C	Temporary loss of function is allowed. Operator intervention is acceptable to restore apparatus function.
	Note: Hardware failures are not acceptable for any level of the above performance criteria.

CONTACT AND ORDERING INFORMATION

Contact Information

Please contact the STEC Solid State Drive Team for more information.

Telephone:	800-796-4645 (Toll free; US and Canada only)
All Others:	(949)260-8345
Fax:	(949) 851-2756
E-mail:	ssd@stec-inc.com

Ordering Information

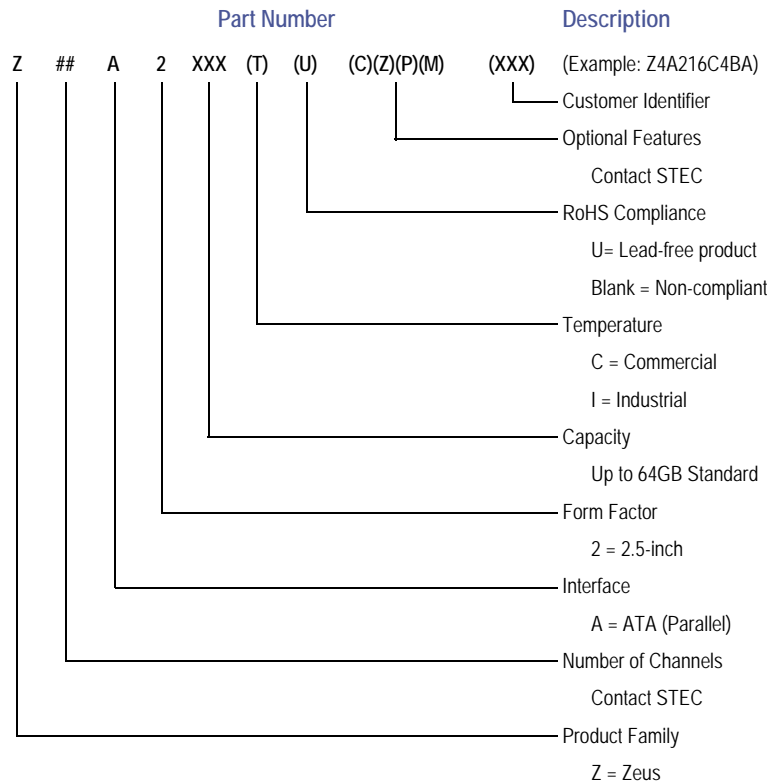



ACRONYMS AND ABBREVIATIONS

A

ARM (Advanced RISC Machine) <processor> (ARM, Originally Acorn RISC Machine). A series of low-cost, power-efficient 32-bit RISC microprocessors for embedded control, computing, digital signal processing, games, consumer multimedia and portable applications.

ATA (AT Attachment) The IDE interface is officially known as the ATA specification. ATA-2 (Fast ATA) defined the faster transfer rates used in Enhanced IDE (EIDE). ATA-3 added interface improvements, including the ability to report potential problems (see S.M.A.R.T.). Starting with ATA-4, either the word "Ultra" or the transfer rate was added to the name in various combinations. For example, at 33 MBytes/sec, terms such as Ultra ATA and ATA-33 have been used. In addition, Ultra ATA-33, DMA-33 and Ultra DMA-33 are also found.

C

CFA (Computer Fraud and Abuse Act of 1986) The CFA was a significant step forward in the prosecution of unauthorized access to computer systems and networks. The Act applies to "federal interest computers" which include systems used by the U.S. government, as well as most financial institutions. The Act makes unauthorized penetration or other damage to such systems a felony.

CHS Cylinder, Head, Sector A disc-drive system and method for generating logical zones that each have an approximate number of spare sectors, and that are used to translate logical block addresses.

CISC (Complex Instruction Set Computer) Pronounced "sisk." The traditional architecture of a computer which uses microcode to execute very comprehensive instructions. Instructions may be variable in length and use all addressing modes, requiring complex circuitry to decode them.

D

DMA (Direct Memory Access) Specialized circuitry or a dedicated microprocessor that transfers data from memory to memory without using the CPU. Although DMA may periodically steal cycles from the CPU, data are transferred much faster than using the CPU for every byte of transfer.

DoD (Department of Defense) The military branch of the U.S. government, which is under the direction of the Secretary of Defense, the primary defense policy adviser to the President.

DSL (Digital Subscriber Line) A technology that dramatically increases the digital capacity of ordinary telephone lines (the local loops) into the home or office. DSL speeds are tied to the distance between the customer and the telco central office (CO). DSL is geared to two types of usage. Asymmetric DSL (ADSL) is for Internet access, where fast downstream is required, but slow upstream is acceptable. Symmetric DSL (SDSL, HDSL, etc.) is designed for short haul connections that require high speed in both directions.

DSLAM (DSL Access Multiplexer) A central office (CO) device for ADSL service that combines voice traffic and DSL traffic onto a customer's DSL line. It also separates incoming phone and data signals and directs them onto the appropriate carriers network.

E

EDC/ECC (Error Detection Code/Error Correction Code) A memory system that tests for and corrects errors automatically, very often without the operating system being aware of it. When writing the data into memory, ECC circuitry generates checksums from the binary sequences in the bytes and stores them in an additional seven bits of memory for 32-bit data paths or eight bits for 64-bit paths. When data are retrieved from memory, the checksum is recomputed to determine if any data bits have been corrupted. Such systems can typically detect and automatically correct errors of one bit per word and can detect, but not correct, errors greater than one bit.

F

FPGA (Field Programmable Gate Array) A type of gate array that is programmed in the field rather than in a semiconductor fabrication facility. Containing up to hundreds of thousands of gates, there are a variety of FPGA architectures on the market. Some are very sophisticated, including not only programmable logic blocks, but programmable interconnects and switches between the blocks. The interconnects take up a lot of FPGA real estate, resulting in a chip with very low gate density compared to other technologies.

H

HDD (Hard Disk Drive) The primary computer storage medium, made of one or more aluminum or glass platters, coated with a ferromagnetic material. Most hard disks are "fixed disks," which have platters that reside permanently in the drive.

I

I/O (Input/Output) Transferring data between the CPU and a peripheral device. Every transfer is an output from one device and an input into another.

IDE (Integrated Drive Electronics) A type of hardware interface widely used to connect hard disks, CD-ROMs and tape drives to a PC. IDE was always the more economical interface, compared to SCSI. Starting out with 40MB capacities years ago, 20GB IDE hard disks have become entry level, costing a fraction of a cent per megabyte.

IO (Input/Output; see I/O)

L

LBA (Logical Block Addressing) A method used to support IDE hard disks larger than 504MB (528,482,304 bytes) on PCs. LBA provides the necessary address conversion in the BIOS to support drives up to 8GB. BIOS after mid-1994, which are sometimes called "Enhanced BIOS," generally provide LBA conversion. LBA support is required for compatibility with the FAT32 directory.

LSB (Least Significant Byte) "Byte" defines a sequence of 8-bits, with the right-most bit being the least significant and the left-most bit being the most-significant.

LSW (Least Significant Word) "Word" denotes sequence of 4 bytes, or 32 bits, with the left-most being the least significant, and the right-most being the most significant. "Double-word" denotes sequence of two words, or 64bits, with the left most word being the least significant, and the right-most - the most significant. Note, that the definition of "word" defines a little-endian scheme, so for big-endian platforms, or network applications, special steps need to be taken to reorder the bytes form the input stream.

M

MLC (Multi-Level Cell) A flash memory technology that stores more than one bit of data per cell. Traditional flash memory defines a 0 or 1 bit, based on a single voltage threshold. The patterns of two bits (0-0, 0-1, 1-0, and 1-1) can be achieved with four voltage levels and eight levels of voltage can yield all the combinations in three bits.

MSB (Most Significant) "byte" defines a sequence of 8-bits, with the right-most bit being the least significant and the left-most bit being the most-significant.

MSW (Most Significant Word) "Word" denotes sequence of 4 bytes, or 32 bits, with the left-most being the least significant, and the right-most being the most significant. "Double-word" denotes sequence of two words, or 64bits, with the left most word being the least significant, and the right-most - the most significant. Note, that the definition of "word" defines a little-endian scheme, so for big-endian platforms, or network applications, special steps need to be taken to reorder the bytes form the input stream.

N

NAND (Not AND) A Boolean logic operation that is true if any single input is false. Two-input NAND gates are often used as the sole logic element on gate array chips, because all Boolean operations can be created from NAND gates.

P

PIO (Programmed Input/Output) The data transfer mode used by IDE drives. PIO modes use the registers of the CPU for data transfer in contrast with DMA, which transfers directly between main memory and the peripheral device.

R

RISC (Reduced Instruction Set Computer) A computer architecture that reduces chip complexity by using simpler instructions. RISC compilers have to generate software routines to perform complex instructions that were previously done in hardware by CISC computers. In RISC, the microcode layer and associated overhead is eliminated.

S

SLC Single-Level Cell A flash memory technology that stores one bit of data per memory cell; supporting only two states: erased (1) or programmed (0).

SMART (Self-Monitoring Analysis and Reporting Technology) An "early warning system" for anticipating pending drive problems. The drive's integrated controller works with various sensors to monitor several aspects of the drive's performance. Using this status information, SMART determines if the drive is behaving normally or not, and then makes the information available to software that probes the drive.

SSD (Solid State Disk) Disk drive that uses memory chips instead of rotating platters for data storage. Used in battery-powered handheld devices as well as desktop computers and servers, solid state disks (SSDs) are faster than regular disks because there is zero latency (there is no read/write head to move). They are also more rugged than hard disks and offer greater protection in hostile environments.

T

True-IDE Flash memory devices (such as CF cards) have a pin that when connected to the proper voltage at power-up selects the "True-IDE" mode of operation instead of the "PC-CARD-ATA" mode of operation. This is the mode used in the interface.

U

Ultra ATA An enhanced version of the IDE interface that transfers data at 33, 66 or 100 Mbytes/sec. These enhancements are also called "Ultra DMA," "UDMA," "ATA-33," "ATA-66," "ATA-100," "DMA-33," "DMA-66" and "DMA-100."

Ultra DMA (see Ultra ATA)



INDEX

A

Altitude	
High Altitude Limit	46
Low Altitude Limit	46
ATA Commands	
Overview	22
Read/Verify Sector(s)	26
Sanitize	40
Sanitize Erase/Fill	40
SMART Support	30
Standard Commands	22
Vendor-Specific	40
Audience	
OEMs	1
system designers	1
system engineers	1

C

Contact Information	61
Email	61
Fax	61
Others	61
Toll Free	61
Conventions	
CAUTION	iii
Electrostatic Discharge	iii
NOTE	iii
SHOCK HAZARD	iii
TIP	iii
Copyright Notice	ii

D

Disclaimer of Liability	ii
-------------------------------	----

E

Electrical Specifications	
Activity LED	14
Grounding	15
Power Consumption	13
Power Mode/Power On	15
Power Requirements	13
Power Savings Commands	15
Start-Up Current Draw	14
Start-Up Time	14
Electromagnetic Compatibility	3
Electromagnetic Susceptibility	3
Environmental Characteristics	
Altitude	45
Conformal Coating	48
Drop Testing	48
Failure Criteria	47
Humidity	45
Non-Operating Conditions	46
Operating Requirements	45
Overview	45
Random Vibration	47
RoHS Directive	47
Shock	47
Temperature	45
Vibration	47
Export Administration Regulations	ii

F

FCC Declaration of Conformity	73
Functional Blocks	
ATA (IDE) Bus Interface	18
ATA Bus Connector	18

Storage Capacity	42	Operating Systems	
I		boot time	56
Identify Device Information	30	DRMK DOS	56
Installation		MS-DOS	56
Cooling Requirements	52	POST	56
Diagnostic Software	56	Red Hat Linux	56
Drive Configuration	50	Resume from Standby	56
Grounding Requirements	55	resume time	56
Jumper Pins	50	Windows 2000	56
Mounting Hole Locations	54	Windows 2000 Server	56
Mounting Holes	53	Windows 2003	56
NAND Flash Support	56	Windows XP	56
Operating Systems		WinPE	56
<i>See Operating Systems</i>	56	Operating Temperature	
System Requirements	49	Commercial	45
Interface Specifications		Industrial	45
Connector Pinout	19	Optional Features	
Functional Blocks	18	Conformal coating	8
SSD Control Block	21	Sanitize Erase/Fill	7
SSD Operation	16	SMART	7
M		Optional Purge Features	
Maintenance	12	BasicPurge	8
Manufacturing		Hardware	8
ISO 14001 Certified	8	Intelligent Destructive Purge	8
United States	8	MilPurge	8
Materials		RapidPurge	8
HB rated	42	Ordering Information	61
UL94V-0	42	P	
O		Performance Characteristics	
Operating Modes		ATA (IDE) Bus Modes	10
Addressing	17	Bad-Block Management	10
Primary Mode	17	Data Retention	10
Secondary Mode	17	ECC	11
		EDC	11

Endurance	10	Korea	57
Reliability	11	Radio Frequency Emissions	58
Wear-Leveling	10	Taiwan	57
Physical Characteristics		Underwriters Laboratories	57
Connector Location	44	Verification Samples	59
Drive Assembly Weight	42	Reliability	
Exterior Dimensions	43	BIST	11
Materials	42	Data Transfer Rates	12
Power Savings Commands		Error Rates	11
Check Power Mode	15	Mount Time	11
Idle	15	Preventative Maintenance	12
Sleep	15	Purge Times	12
Standby	15	Repairs	12
Standby Immediate	15	Seek Time	11
Product Description		Repairs	12
ATA Interface	9	Revision History	v
Data Security	9	S	
Drive Capacities	9	Sanitization Standards	41
General	9	Scope	
Performance	9	ATA Commands	2
Purge Times		Audience	1
BasicPurge	12	Electrical Specifications	2
Intelligent Destructive Purge	12	Environmental Characteristics	2
MilPurge	12	Installation	2
RapidPurge	12	Interface Specifications	2
R		Optional Features	2
Regulatory Compliance		Overview	1
Australia	57	Performance	2
Canadian Standards Association	57	Physical Characteristics	2
CB Report	57	Product Description	2
Electrostatic Discharge (ESD)	60	Reference Documents	1
European Union	57	Regulatory Compliance	2
FCC	57	Standard Features	2
Japan	57	Standards	1

SSD Control Block		Security Freeze Lock	27
FPGA Controller	21	Security Set Password	27
RISC Microcontroller	21	Security Unlock	27
SSD Control Blocks		Seek	28
FPGA Controller	21	Set Features	28
NAND SLC Flash Memory	21	Set Multiple Mode	28
RISC Microcontroller	21	Set Sleep Mode	28
Standard ATA Commands		Sleep	28
Check Power Mode	24	SMART	28
Download Microcode	24	Standby	28
Erase Sector	24	Standby Immediate	29
Execute Drive Diagnostic	24	Write Buffer	29
Flush Cache	24	Write DMA	29
Flush Cache Ext.	24	Write DMA Ext	29
Format Track	25	Write DMA Queued	29
Identify Response	25	Write DMA Queued Ext	29
Idle	25	Write Multiple	29
Idle Immediate	25	Write Multiple Ext	29
Initialize Drive Parameters	25	Write Sector(s) Ext	30
NOP (00h)	25	Write Sectors	30
Read Buffer	25	Standard Features	
Read DMA	25	ATA/IDE Interface	5
Read DMA Ext	25	Compliance	7
Read DMA Queued	26	Endurance	5
Read Mult. Ext	26	Environmental Characteristics	6
Read Multiple	26	Performance	5
Read Read DMA Queued Ext	26	Physical Characteristics	6
Read Sector(s)	26	Power	7
Read Sector(s) Ext	26	Reliability	6
Read/Verify Ext	26	Unformatted Capacities	5
Recalibrate	27	Standards	
Security Disable Password	27	ANSI-INCITS	5
Security Erase Prepare	27	Commercial Standards	4
Security Erase Unit	27	Military Information Systems	4
		Reference Documents	5

System Requirements

ATA interface cable	49
host adapter	49
mounting hardware	49
power source	49

T

Trademark Information	ii
-----------------------------	----

W

Warranty

Limited Warranty	73
Modifications	73



CERTIFICATION AND WARRANTY

FCC Declaration of Conformity



The Zeus Solid State Drive carries the FCC-Mark in accordance with related Federal Communications Commission (FCC)–USA directives. This device complies with Part 15 of the FCC Rules. Operation is subject to the following two conditions:

- This device may not cause harmful interference.
- This device must accept any interference received, including interference that may cause undesired operation.

This equipment has been tested and found to comply with the limits for a Class B digital device, pursuant to Part 15 of the FCC Rules. These limits are designed to provide reasonable protection against harmful interference in a residential installation. This equipment generates, uses and can radiate radio frequency energy and, if not installed and used in accordance with the instructions, may cause harmful interference to radio communications. However, there is no guarantee that interference will not occur in a particular installation. If this equipment does cause harmful interference to radio or television reception, which can be determined by turning the equipment off and on, the user is encouraged to try to correct the interference by one or more of the following measures:

- Re-orient or relocate the receiving antenna.
- Increase the separation between the equipment and receiver.
- Connect the equipment into an outlet on a circuit different from that to which the receiver is connected.
- Consult the dealer or an experienced radio/television technician for help.

Modifications made to this device that are not approved by SimpleTech may void the authority granted to the user by the FCC to operate this equipment.

Limited Warranty

STEC Inc., (STEC) Solid State Drives (SSD) are warranted against defects in material and workmanship, and will operate in substantial conformance with their respective specifications under normal use and service for a period of five (5) years from the date of shipment. Subject to the conditions and limitations set forth below, STEC Inc. will, at its own option, either repair or replace any defective SSD Product that proves to be defective by reasons of improper workmanship or materials, if buyer notifies STEC Inc. of such failure within the stated warranty period. Products repaired or replaced during the applicable warranty period shall be covered by the foregoing warranties for the remainder of the original warranty period or ninety (90) days from the date of reshipment, whichever is longer. Parts used to repair products or replacement products may be provided by STEC Inc. on an exchange basis, and will be either new or refurbished to be functionally equivalent to new.

STEC INC DISCLAIMS ALL OTHER WARRANTIES, EITHER EXPRESSED OR IMPLIED, INCLUDING BUT NOT LIMITED TO IMPLIED WARRANTIES OF MERCHANTABILITY AND FITNESS FOR A PARTICULAR PURPOSE, WITH RESPECT TO ITS PRODUCTS AND ANY ACCOMPANYING WRITTEN MATERIALS. FURTHER, STEC INC. DOES NOT WARRANT THAT SOFTWARE WILL BE FREE FROM DEFECTS OR THAT ITS USE WILL BE UNINTERRUPTED OR REGARDING THE USE, OR THE RESULTS OF THE USE OF THE SOFTWARE IN TERMS OF CORRECTNESS, ACCURACY, RELIABILITY OR OTHERWISE.

STEC Inc. is not responsible for updates or functionality of third-party software. Software is provided with notices and/or licenses from third parties which govern your use.

Modifications

Any changes or modifications made to this device that are not expressly approved by STEC Inc. will void the user's warranty. All wiring external to the product should follow the provisions of the current edition of the National Electrical Code.



61000-04541-101; Revision 1.5

STEC Inc.

World Headquarters

3001 Daimler Street
Santa Ana, CA 92705 USA

Tel: 949.476.1180

Fax: 949.476.1209

Web: www.stec-inc.com