



**CLASS 'C' HIGH POWER OPERATIONAL AMPLIFIER**

**141/142**

**M.S.KENNEDY CORP.**

4707 Dey Road Liverpool, N.Y. 13088

(315) 701-6751

**FEATURES:**

- Internally Compensated For Gains > 10 V/V
- Low Cost
- High Voltage Operation: 150V
- Ultra Low Quiescent Current:  $\pm 4.0$  mA Typ.
- High Output Current: 5A Min.
- No Second Breakdown
- Monolithic MOS Technology

**MIL-PRF-38534 QUALIFIED**

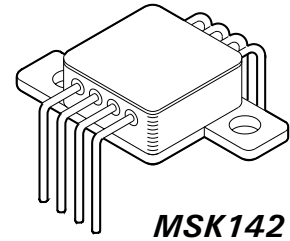
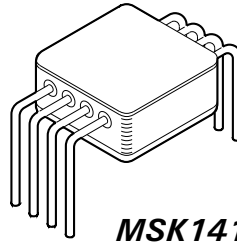

**DESCRIPTION:**

The MSK 141 is a high power monolithic MOSFET class 'C' operational amplifier ideally suited for high power amplification and magnetic deflection applications. With a total supply voltage rating of 150 volts and 5A of available output current, the MSK 141 is also an excellent low cost choice for motor drive circuits. The MOSFET output frees the MSK 141 from secondary breakdown limitations and power dissipation is kept to a minimum with a quiescent current rating of  $\pm 4.0$  mA. The MSK 141 is packaged in a hermetically sealed 8 pin power dip and is internally compensated for gains larger than 10 V/V. For applications requiring heat sinking, the MSK 142 is available with bolt down tabs and is otherwise identical to the MSK 141 (see mechanical specifications).

**EQUIVALENT SCHEMATIC**

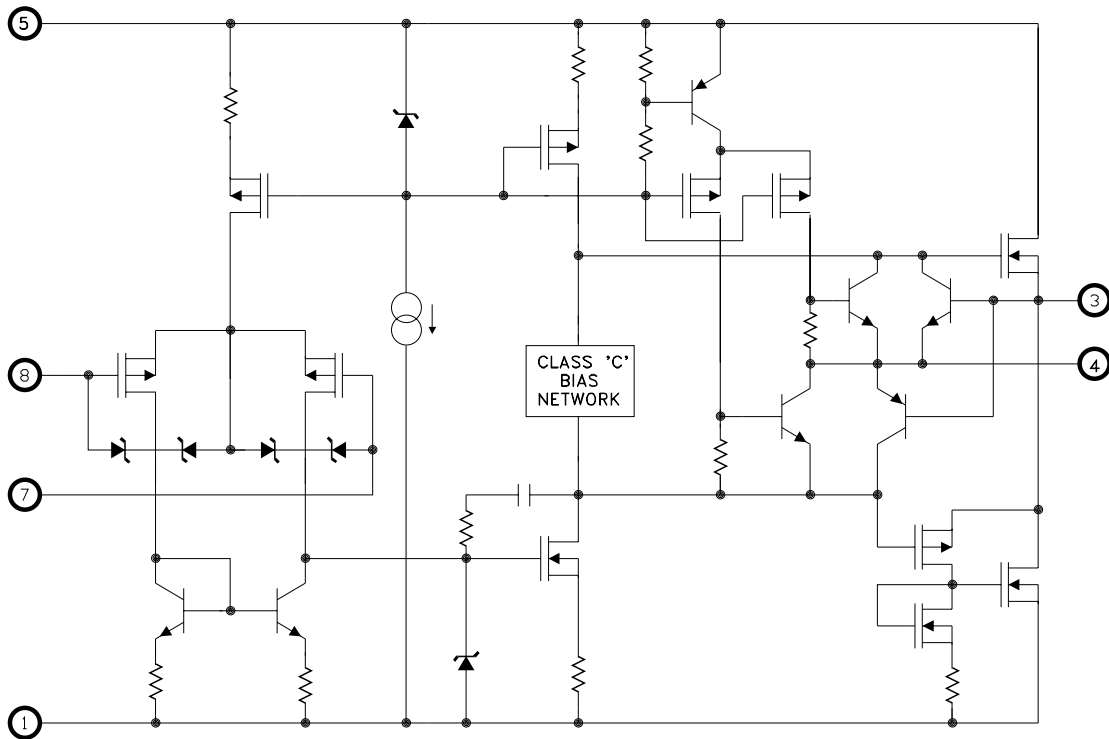

**TYPICAL APPLICATIONS**

- PA Audio
- Magnetic Deflection
- Motor Drive
- Noise Cancellation
- DC Power Regulators

**PIN-OUT INFORMATION**

- |                 |                       |
|-----------------|-----------------------|
| 1 -Vcc          | 8 Inverting Input     |
| 2 N/C           | 7 Non-Inverting Input |
| 3 Output Drive  | 6 N/C                 |
| 4 Current Sense | 5 +Vcc                |

## ABSOLUTE MAXIMUM RATINGS

$V_{CC}$ ②	Total Supply Voltage . . . . .	150V	$T_{ST}$	Storage Temperature . . . . .	-65°C to +150°C
$\pm I_{OUT}$	Output Current (within S.O.A.) . . . . .	$\pm 5A$	$T_{LD}$	Lead Temperature . . . . .	300°C
$V_{IND}$	Input Voltage (Differential) . . . . .	$\pm 16V$	$T_C$	Case Operating Temperature (MSK141B/142B) . . . . .	-55°C to +125°C
$V_{IN}$	Input Voltage (Common Mode) . . . . .	$\pm V_{CC}$		(MSK141/142) . . . . .	-40°C to +85°C
$T_J$	Junction Temperature . . . . .	150°C	$R_{TH}$	Thermal Resistance (DC) Junction to Case . . . . .	1.0°C/W

## ELECTRICAL SPECIFICATIONS

Parameter	Test Conditions ①	Group A Subgroup	MSK141B/142B			MSK141/142			Units
			Min.	Typ.	Max.	Min.	Typ.	Max.	
<b>STATIC</b>									
Supply Voltage Range ② ④		-	$\pm 15$	$\pm 50$	$\pm 75$	$\pm 15$	$\pm 50$	$\pm 75$	V
Quiescent Current	$V_{IN} = 0V$	1	-	$\pm 4$	$\pm 6$	-	$\pm 4$	$\pm 8$	mA
<b>INPUT</b>									
Offset Voltage	$V_{IN} = 0V$	1	-	$\pm 5$	$\pm 10$	-	$\pm 5$	$\pm 15$	mV
Offset Voltage Drift ④	$V_{IN} = 0V$	2,3	-	$\pm 10$	$\pm 50$	-	$\pm 10$	-	$\mu V/^\circ C$
Offset Voltage vs $\pm V_{CC}$ ④	$V_{IN} = 0V$	1	-	$\pm 8$	$\pm 15$	-	$\pm 8$	$\pm 15$	$\mu V/V$
Input Bias Current ④	$V_{CM} = 0V$	1,3	-	$\pm 20$	$\pm 100$	-	$\pm 20$	$\pm 100$	pA
		2	-	-	$\pm 50$	-	-	-	nA
Input Impedance ④	(DC)	-	-	$10^{11}$	-	-	$10^{11}$	-	$\Omega$
Input Capacitance ④		-	-	5	-	-	5	-	pF
Common Mode Rejection ④	$V_{CM} = \pm 30VDC$	-	90	106	-	90	106	-	dB
Noise	10KHz BW	-	-	10	-	-	10	-	$\mu VRMS$
<b>OUTPUT</b>									
Output Voltage Swing	$I_{OUT} = \pm 5A$ Peak	4	$\pm 40$	$\pm 42$	-	$\pm 40$	$\pm 42$	-	V
Output Current	$V_{OUT} = MAX$	4	$\pm 5$	$\pm 5.5$	-	$\pm 5$	$\pm 5.5$	-	A
Power Bandwidth ④ ⑨	$V_{OUT} = 80V_{PP}$	-	-	66	-	-	66	-	KHz
Settling Time to 0.1% ③ ④	10V Step	-	-	2	-	-	2	-	$\mu S$
Capacitive Load ④	$A_V = +10 V/V$	-	10	-	-	10	-	-	nF
<b>TRANSFER CHARACTERISTICS</b>									
Slew Rate ④ ⑨		-	-	27	-	-	27	-	$V/\mu S$
Open Loop Voltage Gain ④	$F = 15Hz$	4	94	106	-	94	106	-	dB

### NOTES:

- ① Unless otherwise noted  $\pm V_{CC} = \pm 50VDC$ .
- ② Derate maximum supply voltage 0.5V/°C below  $T_C = +25^\circ C$ . No derating is needed above  $T_C = 25^\circ C$ .
- ③  $A_V = -10V/V$  measured in false summing junction circuit.
- ④ Devices shall be capable of meeting the parameter, but need not be tested. Typical parameters are for reference only.
- ⑤ Industrial grade devices shall be tested to subgroups 1 and 4 unless otherwise requested.
- ⑥ Military grade devices ('B' suffix) shall be 100% tested to subgroups 1,2,3 and 4.
- ⑦ Subgroup 5 and 6 testing available upon request.
- ⑧ Subgroup 1,4  $T_C = +25^\circ C$   
Subgroup 2,5  $T_C = +125^\circ C$   
Subgroup 3,6  $T_A = -55^\circ C$
- ⑨ Parameter is specified with the output above the deadband near zero volts.

## APPLICATION NOTES

### CURRENT LIMIT (SEE TYPICAL CONNECTION DIAGRAM)

A value of current limit resistance can be calculated as follows:

$$R_{CL} = (0.83 - (0.05 * I_{CL})) / I_{CL}$$

Where:

$R_{CL}$  is the current limit resistor value

$I_{CL}$  is the current limit

$0.05 * I_{CL}$  is the voltage dropped in the current limit path across internal impedances other than the actual current limit resistor

0.83 volts is the voltage drop that must be developed across the current limit connections to activate the current limit circuit

The maximum practical value of current limit resistance is 16 ohms. The current limit resistor will decrease available output voltage swing in the following manner:

$$V_R = I_O * R_{CL}$$

$V_R$  is the reduction in output voltage swing due to the current limit resistor. It is recommended the user limit output current to a value as close to the required output current as possible, without clipping output voltage swing. Current limit will vary with case temperature. Refer to the typical performance curves to predict current limit drift. If current limit is not required replace the resistor with a short.

### STABILITY

It is recommended that the parallel sum of the input and feedback resistor be 1000 ohms or less to minimize phase shift caused by the R-C network formed by the input resistor, feedback resistor and input capacitance. An effective method of checking amplifier stability is to apply the worst case capacitive load to the output of the amplifier and drive a small signal square wave across it. If overshoot is less than 25%, the system will typically be stable.

### INPUT PROTECTION

Input protection circuitry within the MSK 141/142 will clip differential input voltages greater than 16 volts. The inputs are also protected against common mode voltages up to the supply rails as well as static discharge. There are 300 ohm current limiting resistors in series with each input. These resistors may become damaged in the event the input overload is capable of driving currents above 1mA. If severe overload conditions are expected, external input current limiting resistors are recommended.

### CLASS "C" PERFORMANCE

The MSK 141/142 output is biased for class "C" operation to yield ultra low quiescent current. A small amount of crossover distortion will be present under heavy load conditions. The user must verify that this condition will not affect circuit performance. Applications requiring a high degree of linearity near the zero point with minimum distortion should use the MSK 151/152.

### SAFE OPERATING AREA (SOA)

The MOSFET output stage of this power operational amplifier has two distinct limitations:

1. The current handling capability of the die metallization.
2. The junction temperature of the output MOSFET's.

NOTE: The output stage is protected against transient flyback. However, for protection against sustained, high energy flyback, external fast-recovery reverse biased diodes should be connected from the output to ground.

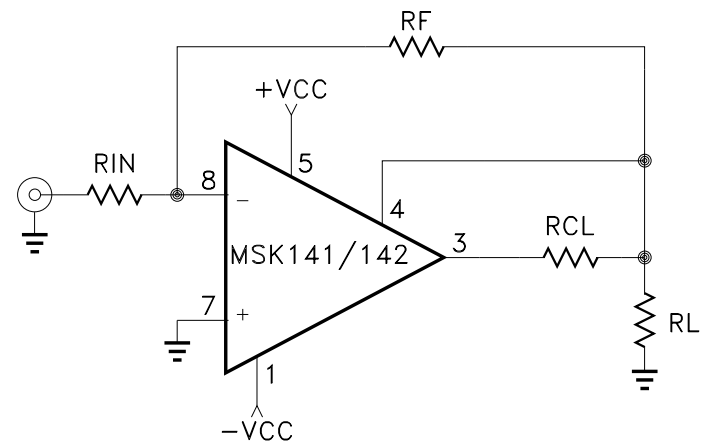
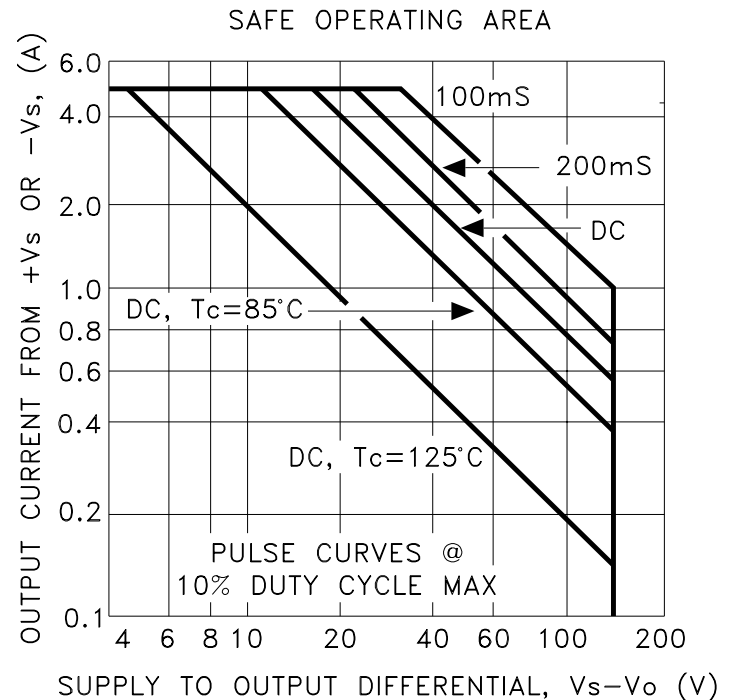

TYPICAL CONNECTION DIAGRAM

# TYPICAL PERFORMANCE CURVES

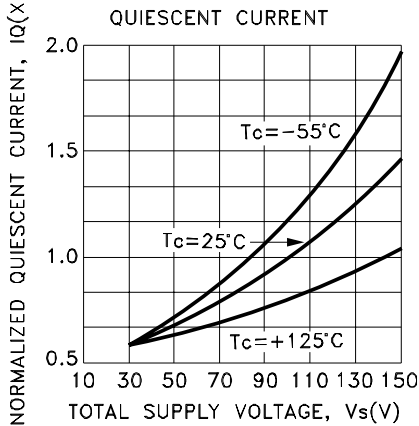
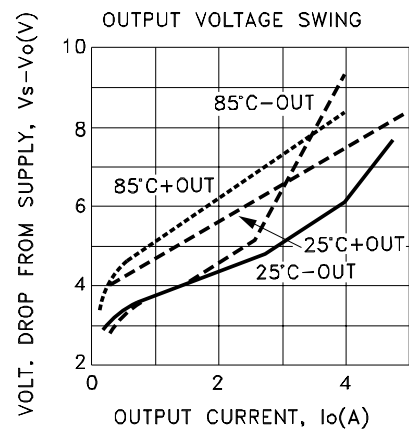
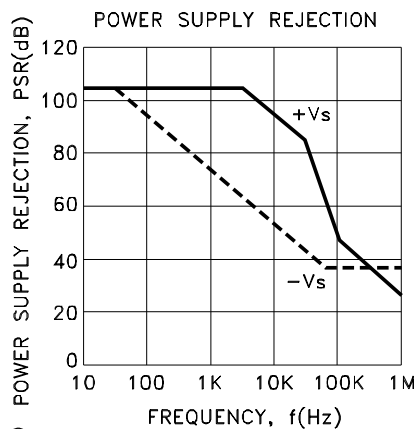
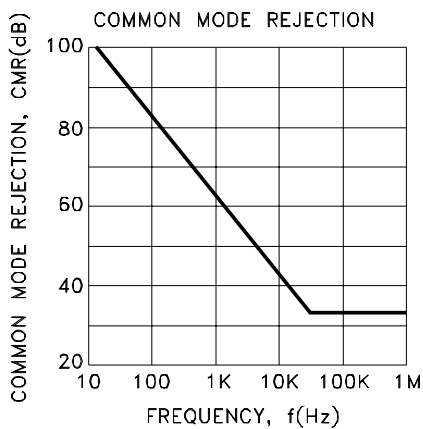
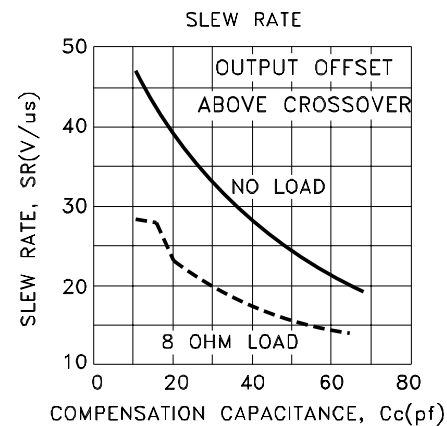
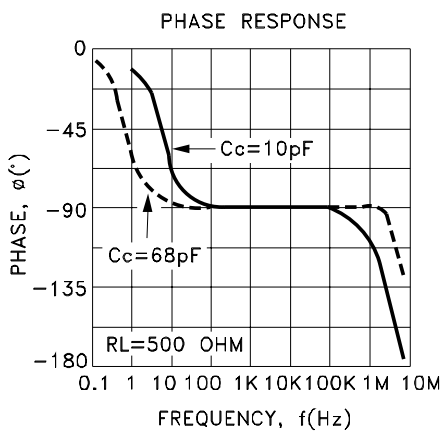
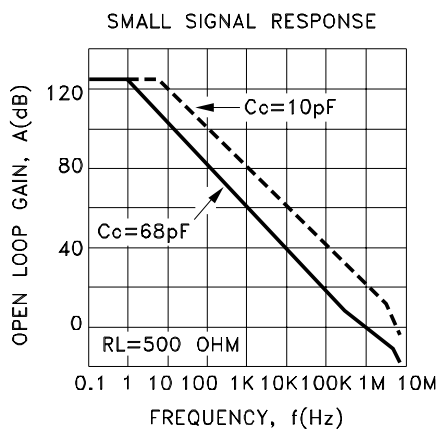
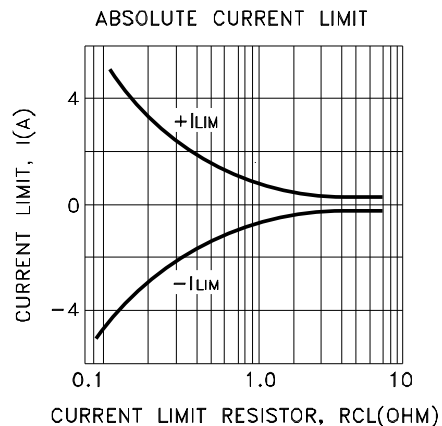
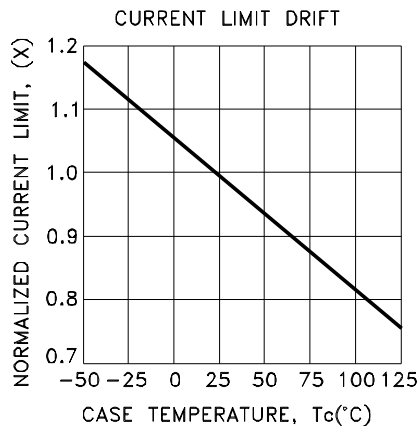
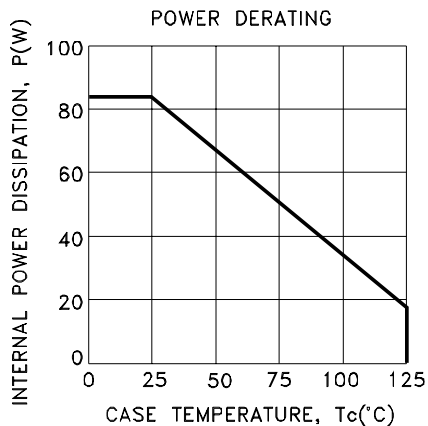



# MECHANICAL SPECIFICATIONS

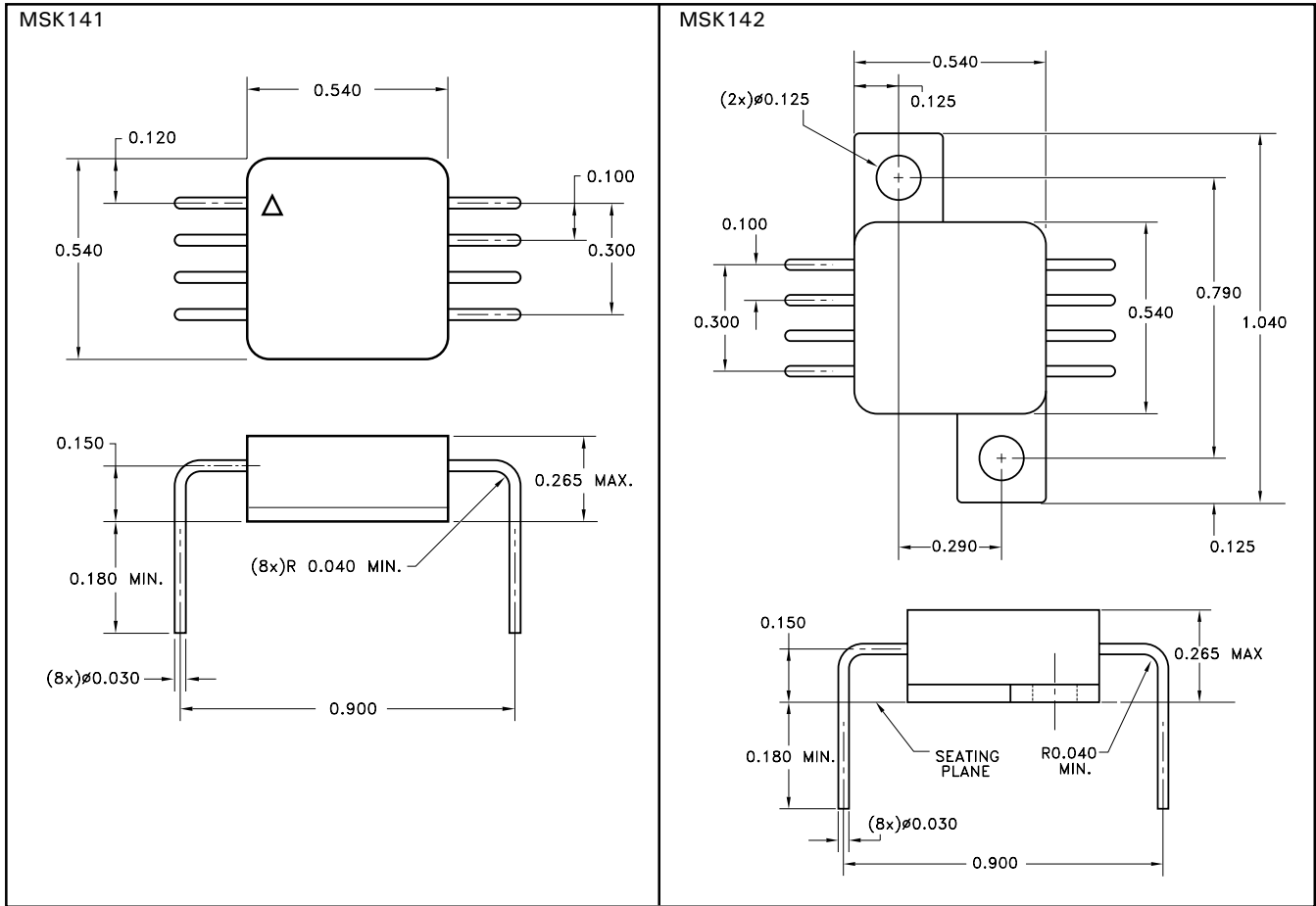

ESD TRIANGLE INDICATES PIN 1.  
 ALL DIMENSIONS ARE  $\pm 0.010$  INCHES UNLESS OTHERWISE LABELED.

## ORDERING INFORMATION

Part Number	Screening Level
MSK141	Industrial
MSK141B	Military-Mil-PRF-38534
MSK142	Industrial
MSK142B	Military-Mil-PRF-38534

M.S. Kennedy Corp.  
 4707 Dey Road, Liverpool, New York 13088  
 Phone (315) 701-6751  
 FAX (315) 701-6752  
[www.mskennedy.com](http://www.mskennedy.com)

The information contained herein is believed to be accurate at the time of printing. MSK reserves the right to make changes to its products or specifications without notice, however, and assumes no liability for the use of its products.