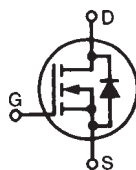


**Power MOSFET TrenchHV™ IXFH160N15T**  
**HiPerFET™**

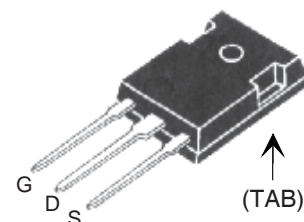
 N-Channel Enhancement Mode  
 Avalanche Rated


$$V_{DSS} = 150V$$

$$I_{D25} = 160A$$

$$R_{DS(on)} \leq 9.6m\Omega$$

Symbol	Test Conditions	Maximum	Ratings
$V_{DSS}$	$T_J = 25^\circ C$ to $175^\circ C$	150	V
$V_{DGR}$	$T_J = 25^\circ C$ to $175^\circ C$ , $R_{GS} = 1M\Omega$	150	V
$V_{GSM}$	Transient	$\pm 30$	V
$I_{D25}$	$T_C = 25^\circ C$	160	A
$I_{LRMS}$	Lead Current Limit, RMS	75	A
$I_{DM}$	$T_C = 25^\circ C$ , pulse width limited by $T_{JM}$	430	A
$I_A$	$T_C = 25^\circ C$	5	A
$E_{AS}$	$T_C = 25^\circ C$	1	J
$dV/dt$	$I_S \leq I_{DM}$ , $V_{DD} \leq V_{DSS}$ , $T_J \leq 175^\circ C$	10	V/ns
$P_d$	$T_C = 25^\circ C$	830	W
$T_J$		-55 ... +175	$^\circ C$
$T_{JM}$		175	$^\circ C$
$T_{stg}$		-55 ... +175	$^\circ C$
$T_L$	1.6 mm (0.062 in.) from case for 10s	300	$^\circ C$
$T_{SOLD}$	Plastic body for 10 seconds	260	$^\circ C$
$M_d$	Mounting torque	1.13 / 10	Nm/lb.in.
<b>Weight</b>		6	g

**TO-247 (IXFH)**

 G = Gate      D = Drain  
 S = Source    TAB = Drain

**Features**

- Unclamped Inductive Switching (UIS) rated
- Low package inductance
  - easy to drive and to protect
- 175  $^\circ C$  Operating Temperature

**Advantages**

- Easy to mount
- Space savings
- High power density

**Applications**

- DC-DC converters
- Battery chargers
- Switched-mode and resonant-mode power supplies
- DC choppers
- AC motor control
- Uninterruptible power supplies
- High speed power switching applications

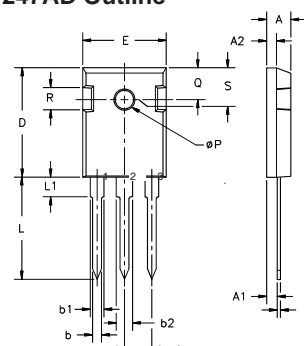
Symbol	Test Conditions	Characteristic Values		
		Min.	Typ.	Max.
$BV_{DSS}$	$V_{GS} = 0V$ , $I_D = 250\mu A$	150		V
$V_{GS(th)}$	$V_{DS} = V_{GS}$ , $I_D = 1mA$	2.5		5.0 V
$I_{GSS}$	$V_{GS} = \pm 20V$ , $V_{DS} = 0V$			$\pm 200$ nA
$I_{DSS}$	$V_{DS} = V_{DSS}$ $V_{GS} = 0V$ $T_J = 150^\circ C$			5 $\mu A$ 250 $\mu A$
$R_{DS(on)}$	$V_{GS} = 10V$ , $I_D = 0.5 \cdot I_{D25}$ , Note 1	8.0		9.6 m $\Omega$

Symbol	Test Conditions	Characteristic Values		
		Min.	Typ.	Max.
(T <sub>J</sub> = 25°C unless otherwise specified)				
<b>g<sub>fs</sub></b>	V <sub>DS</sub> = 10V, I <sub>D</sub> = 60A, Note 1	65	105	S
<b>C<sub>iss</sub></b>	V <sub>GS</sub> = 0V, V <sub>DS</sub> = 25V, f = 1 MHz		8800	pF
<b>C<sub>oss</sub></b>			1170	pF
<b>C<sub>rss</sub></b>			150	pF
<b>t<sub>d(on)</sub></b>	<b>Resistive Switching Times</b> V <sub>GS</sub> = 10V, V <sub>DS</sub> = 0.5 • V <sub>DSS</sub> , I <sub>D</sub> = 0.5 • I <sub>D25</sub> R <sub>G</sub> = 2Ω (External)		21	ns
<b>t<sub>r</sub></b>			21	ns
<b>t<sub>d(off)</sub></b>			52	ns
<b>t<sub>f</sub></b>			29	ns
<b>Q<sub>g(on)</sub></b>	V <sub>GS</sub> = 10V, V <sub>DS</sub> = 0.5 • V <sub>DSS</sub> , I <sub>D</sub> = 25A		160	nC
<b>Q<sub>gs</sub></b>			43	nC
<b>Q<sub>gd</sub></b>			46	nC
<b>R<sub>thJC</sub></b>			0.18	°C/W
<b>R<sub>thCS</sub></b>		0.25		°C/W

Symbol	Test Conditions	Characteristic Values		
		Min.	Typ.	Max.
(T <sub>J</sub> = 25°C, unless otherwise specified)				
<b>I<sub>S</sub></b>	V <sub>GS</sub> = 0V			160 A
<b>I<sub>SM</sub></b>	Repetitive, pulse width limited by T <sub>JM</sub>			430 A
<b>V<sub>SD</sub></b>	I <sub>F</sub> = I <sub>S</sub> , V <sub>GS</sub> = 0V, Note 1			1.2 V
<b>t<sub>rr</sub></b>	I <sub>F</sub> = 80A, -di/dt = 200A/μs V <sub>R</sub> = 75V, V <sub>GS</sub> = 0V		90	160 μs
<b>Q<sub>RM</sub></b>			12	A
<b>I<sub>RM</sub></b>			0.55	μC

Notes: 1. Pulse test, t ≤ 300μs; duty cycle, d ≤ 2%.

### TO-247AD Outline



Terminals: 1 - Gate  
2 - Drain  
3 - Source  
Tab - Drain

Dim.	Millimeter		Inches	
	Min.	Max.	Min.	Max.
A	4.7	5.3	.185	.209
A <sub>1</sub>	2.2	2.54	.087	.102
A <sub>2</sub>	2.2	2.6	.059	.098
b	1.0	1.4	.040	.055
b <sub>1</sub>	1.65	2.13	.065	.084
b <sub>2</sub>	2.87	3.12	.113	.123
C	.4	.8	.016	.031
D	20.80	21.46	.819	.845
E	15.75	16.26	.610	.640
e	5.20	5.72	0.205	0.225
L	19.81	20.32	.780	.800
L1		4.50		.177
ÆP	3.55	3.65	.140	.144
Q	5.89	6.40	0.232	0.252
R	4.32	5.49	.170	.216
S	6.15	BSC	242	BSC

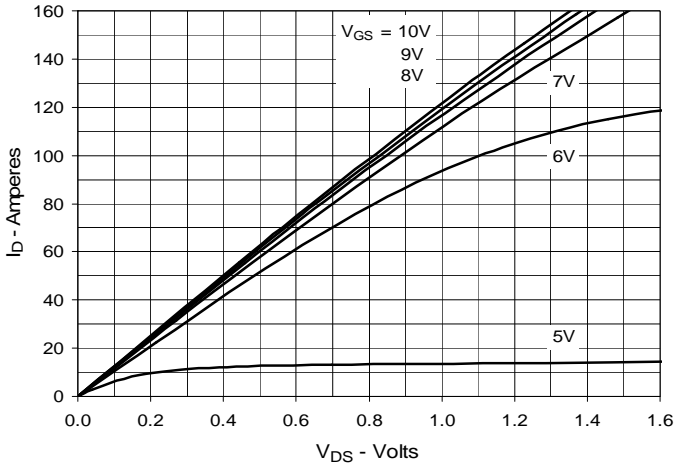
### PRELIMINARY TECHNICAL INFORMATION

The product presented herein is under development. The Technical Specifications offered are derived from data gathered during objective characterizations of preliminary engineering lots; but also may yet contain some information supplied during a pre-production design evaluation. IXYS reserves the right to change limits, test conditions, and dimensions without notice.

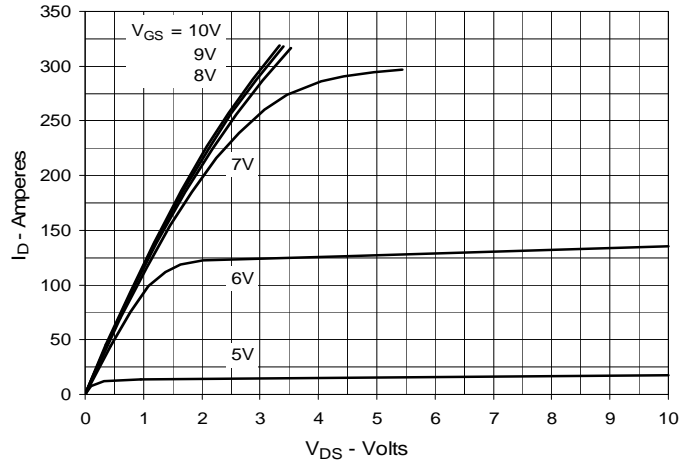
IXYS reserves the right to change limits, test conditions, and dimensions.

IXYS MOSFETs and IGBTs are covered 4,835,592 4,931,844 5,049,961 5,237,481 6,162,665 6,404,065 B1 6,683,344 6,727,585 7,005,734 B2 7,157,338B2  
by one or more of the following U.S. patents: 4,850,072 5,017,508 5,063,307 5,381,025 6,259,123 B1 6,534,343 6,710,405 B2 6,759,692 7,063,975 B2  
4,881,106 5,034,796 5,187,117 5,486,715 6,306,728 B1 6,583,505 6,710,463 6,771,478 B2 7,071,537

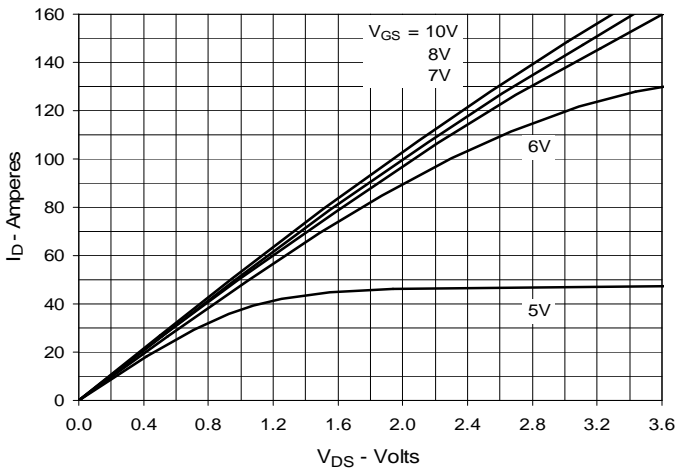
**Fig. 1. Output Characteristics @ 25°C**



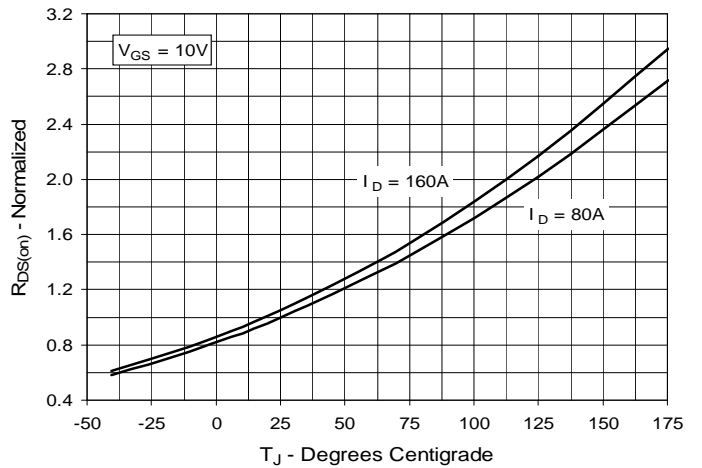
**Fig. 2. Extended Output Characteristics @ 25°C**



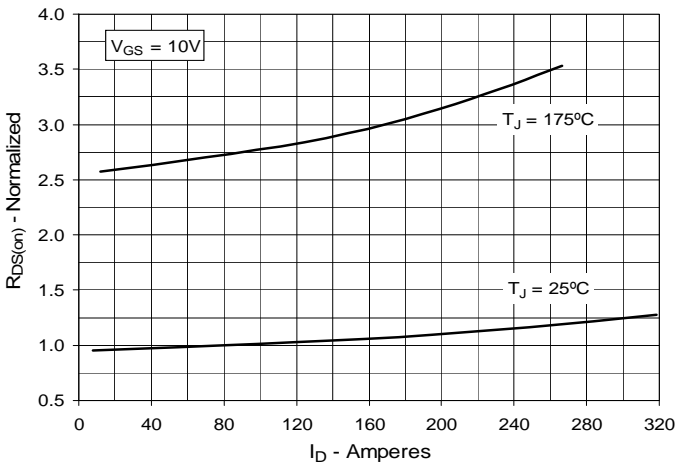
**Fig. 3. Output Characteristics @ 150°C**



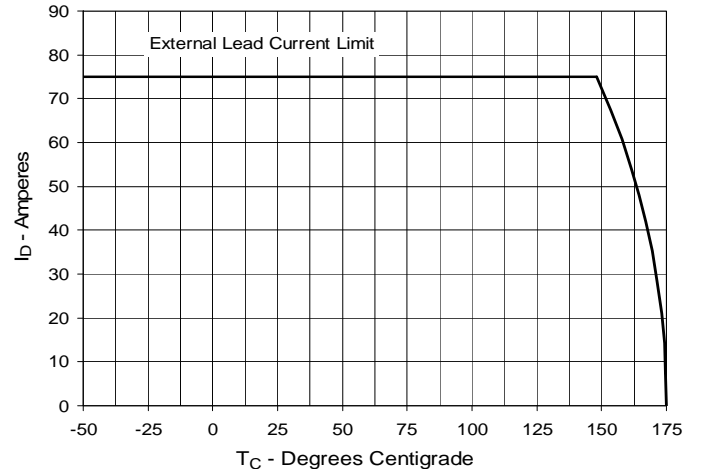
**Fig. 4.  $R_{DS(on)}$  Normalized to  $I_D = 80A$  Value vs. Junction Temperature**



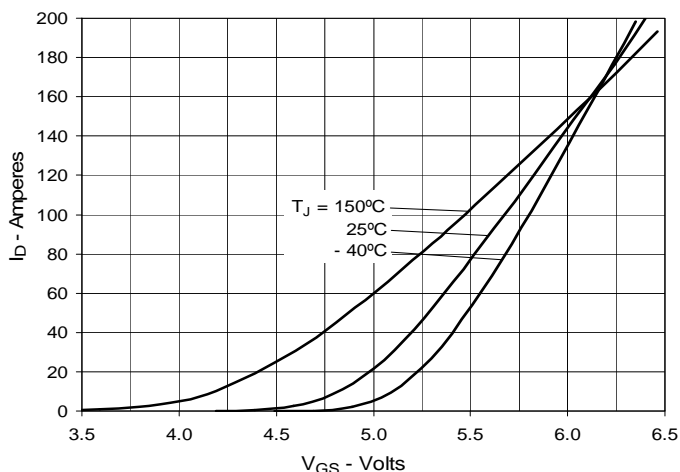
**Fig. 5.  $R_{DS(on)}$  Normalized to  $I_D = 80A$  Value vs. Drain Current**



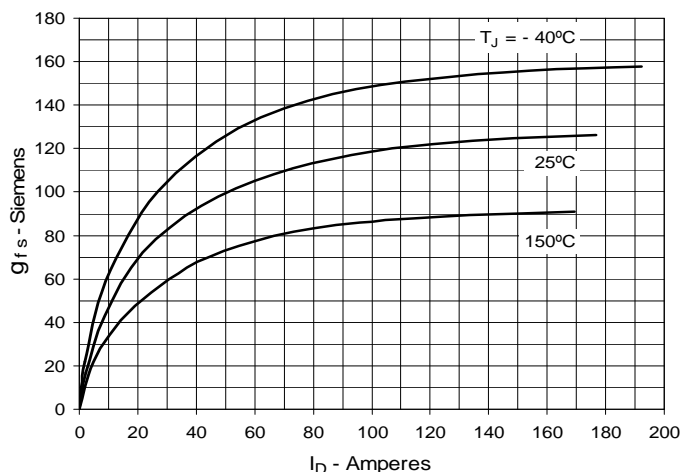
**Fig. 6. Drain Current vs. Case Temperature**



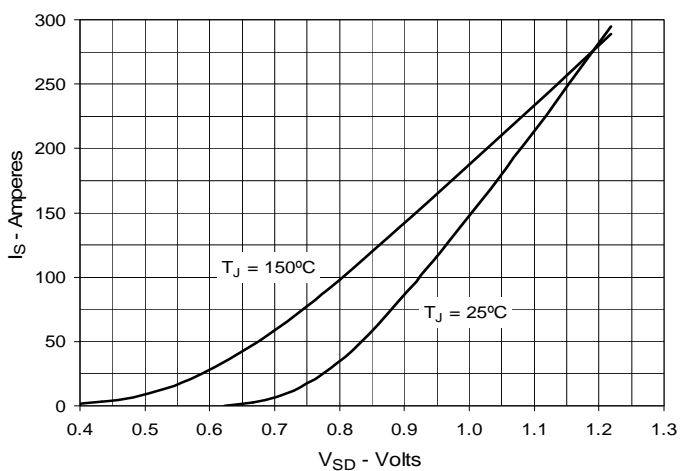
**Fig. 7. Input Admittance**



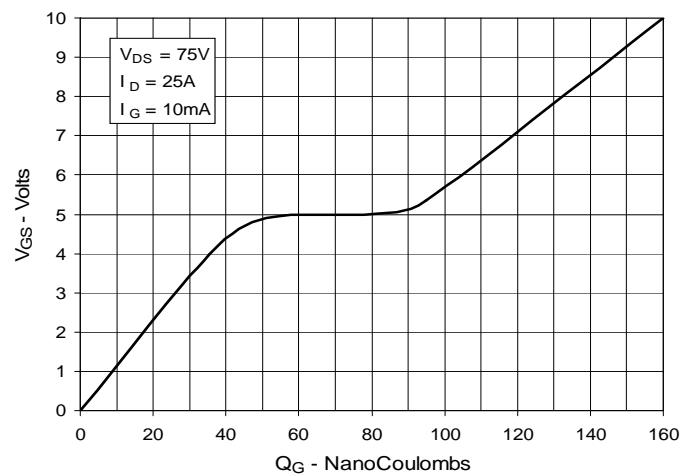
**Fig. 8. Transconductance**



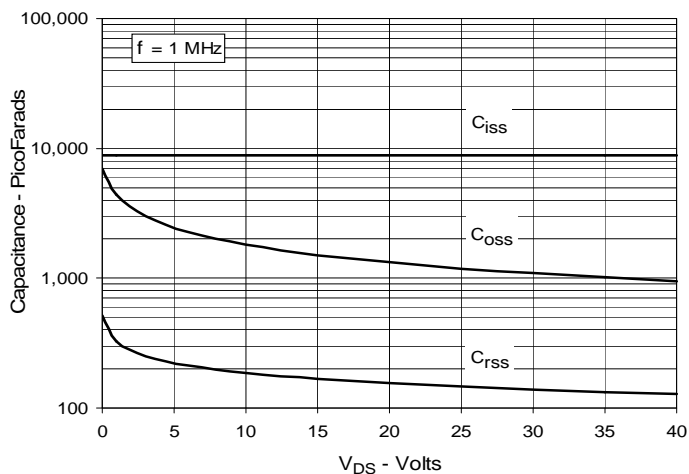
**Fig. 9. Forward Voltage Drop of Intrinsic Diode**



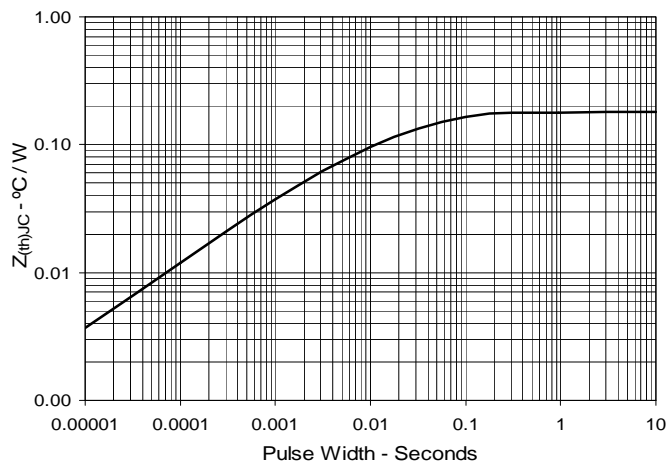
**Fig. 10. Gate Charge**

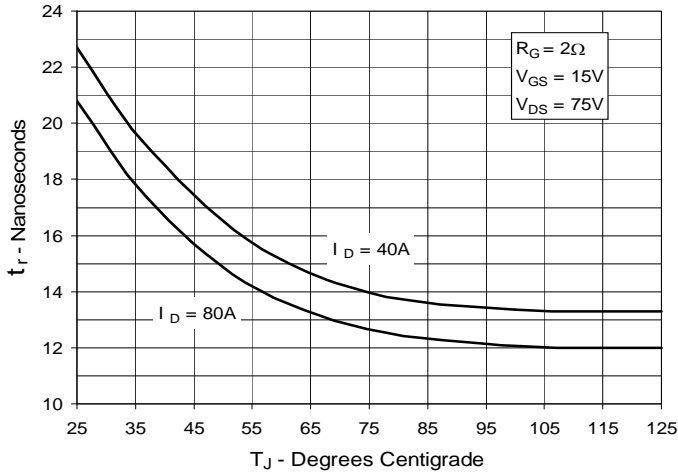
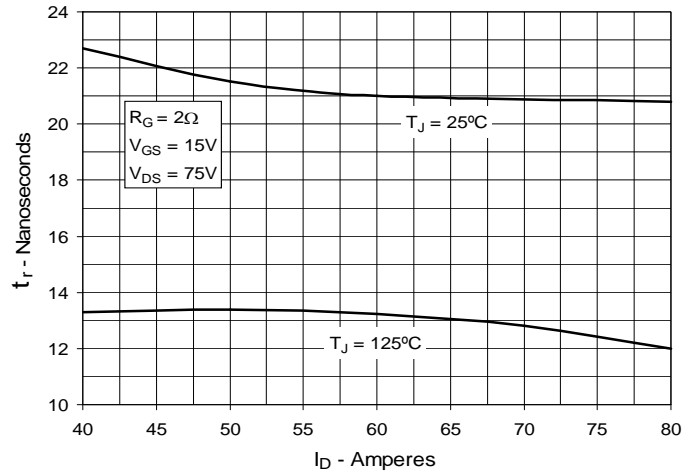
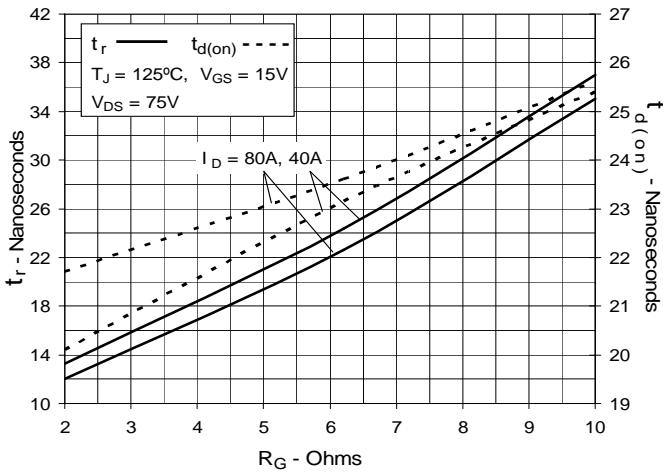
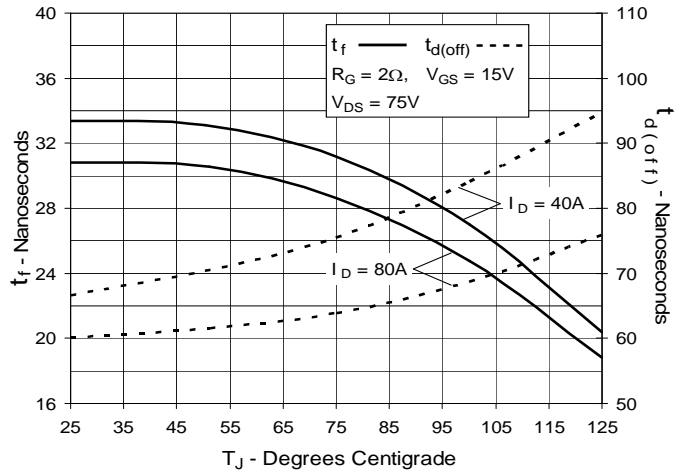
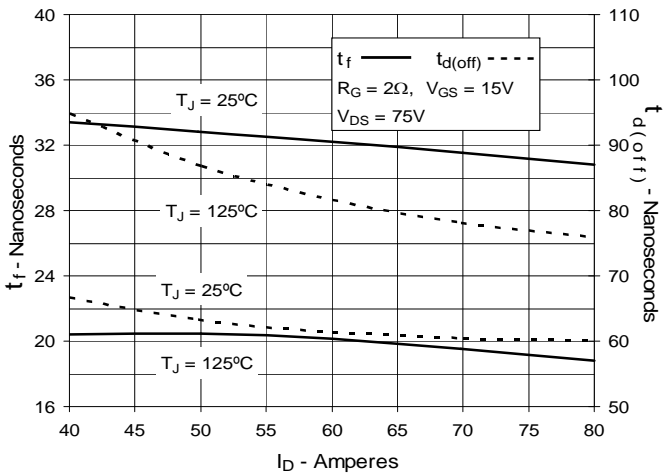


**Fig. 11. Capacitance**



**Fig. 12. Maximum Transient Thermal Impedance**



**Fig. 13. Resistive Turn-on Rise Time vs. Junction Temperature**

**Fig. 14. Resistive Turn-on Rise Time vs. Drain Current**

**Fig. 15. Resistive Turn-on Switching Times vs. Gate Resistance**

**Fig. 16. Resistive Turn-off Switching Times vs. Junction Temperature**

**Fig. 17. Resistive Turn-off Switching Times vs. Drain Current**

**Fig. 18. Resistive Turn-off Switching Times vs. Gate Resistance**
