

# BCR8CM

MEDIUM POWER USE

NON-INSULATED TYPE, PLANAR PASSIVATION TYPE

**BCR8CM**



- **IT (RMS)** ..... **8A**
- **VDRM** ..... **400V/600V**
- **IFGT I , IRGT I , IRGT III** ..... **30mA (20mA) \*5**

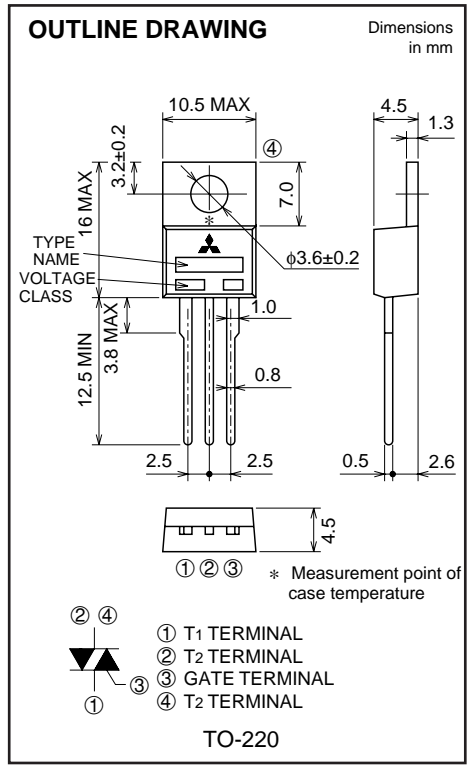

## APPLICATION

Contactless AC switches, light dimmer, electric flasher unit, control of household equipment such as TV sets · stereo · refrigerator · washing machine · infrared kotatsu · carpet · electric fan, solenoid drivers, small motor control, copying machine, electric tool, other general purpose control applications

## MAXIMUM RATINGS

Symbol	Parameter	Voltage class		Unit
		8	12	
VDRM	Repetitive peak off-state voltage *1	400	600	V
VDSM	Non-repetitive peak off-state voltage *1	500	720	V

Symbol	Parameter	Conditions	Ratings	Unit
IT (RMS)	RMS on-state current	Commercial frequency, sine full wave 360° conduction, Tc=105°C	8	A
ITSM	Surge on-state current	60Hz sinewave 1 full cycle, peak value, non-repetitive	80	A
I <sup>2</sup> t	I <sup>2</sup> t for fusing	Value corresponding to 1 cycle of half wave 60Hz, surge on-state current	26	A <sup>2</sup> s
PGM	Peak gate power dissipation		5	W
PG (AV)	Average gate power dissipation		0.5	W
VGM	Peak gate voltage		10	V
IGM	Peak gate current		2	A
Tj	Junction temperature		-40 ~ +125	°C
Tstg	Storage temperature		-40 ~ +125	°C
—	Weight	Typical value	2.0	g

\*1. Gate open.

# BCR8CM

MEDIUM POWER USE

NON-INSULATED TYPE, PLANAR PASSIVATION TYPE

## ELECTRICAL CHARACTERISTICS

Symbol	Parameter	Test conditions	Limits			Unit	
			Min.	Typ.	Max.		
IDRM	Repetitive peak off-state current	T <sub>j</sub> =125°C, V <sub>DRM</sub> applied	—	—	2.0	mA	
V <sub>TM</sub>	On-state voltage	T <sub>c</sub> =25°C, I <sub>TM</sub> =12A, Instantaneous measurement	—	—	1.5	V	
V <sub>FGT I</sub>	Gate trigger voltage *2	T <sub>j</sub> =25°C, V <sub>D</sub> =6V, R <sub>L</sub> =6Ω, R <sub>G</sub> =330Ω	I	—	—	1.5	V
V <sub>RGT I</sub>			II	—	—	1.5	V
V <sub>RGT III</sub>			III	—	—	1.5	V
I <sub>FGT I</sub>	Gate trigger current *2	T <sub>j</sub> =25°C, V <sub>D</sub> =6V, R <sub>L</sub> =6Ω, R <sub>G</sub> =330Ω	I	—	—	30*5	mA
I <sub>RGT I</sub>			II	—	—	30*5	mA
I <sub>RGT III</sub>			III	—	—	30*5	mA
V <sub>GD</sub>	Gate non-trigger voltage	T <sub>j</sub> =125°C, V <sub>D</sub> =1/2V <sub>DRM</sub>	0.2	—	—	V	
R <sub>th(j-c)</sub>	Thermal resistance	Junction to case *4	—	—	2.0	°C/W	
(dv/dt) <sub>c</sub>	Critical-rate of rise of off-state commutating voltage		*3	—	—	V/μs	

- \*2. Measurement using the gate trigger characteristics measurement circuit.
- \*3. The critical-rate of rise of the off-state commutating voltage is shown in the table below.
- \*4. The contact thermal resistance R<sub>th(c-f)</sub> in case of greasing is 1.0°C/W.
- \*5. High sensitivity (I<sub>GT</sub>≤20mA) is also available. (I<sub>GT</sub> item ①)

Voltage class	V <sub>DRM</sub> (V)	(dv/dt) <sub>c</sub>			Test conditions	Commutating voltage and current waveforms (inductive load)
		Symbol	Min.	Unit		
8	400	R	—	V/μs	1. Junction temperature T <sub>j</sub> =125°C 2. Rate of decay of on-state commutating current (di/dt) <sub>c</sub> =-4A/ms 3. Peak off-state voltage V <sub>D</sub> =400V	
		L	10			
12	600	R	—			
		L	10			

## PERFORMANCE CURVES

MAXIMUM ON-STATE CHARACTERISTICS

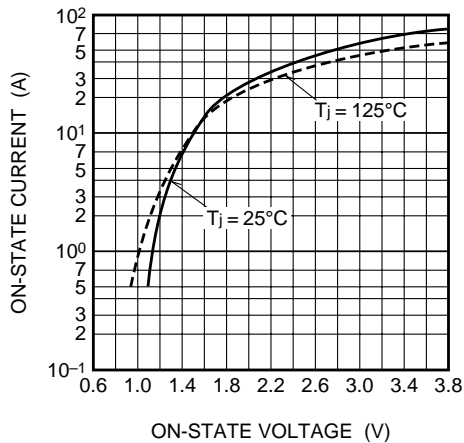

RATED SURGE ON-STATE CURRENT

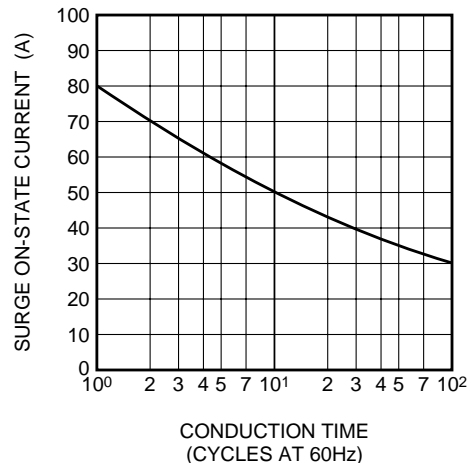

# BCR8CM

MEDIUM POWER USE

NON-INSULATED TYPE, PLANAR PASSIVATION TYPE

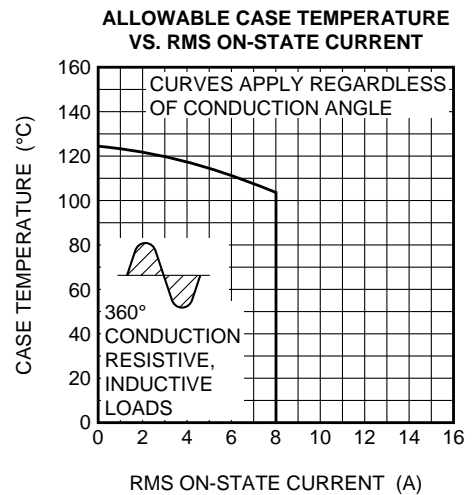
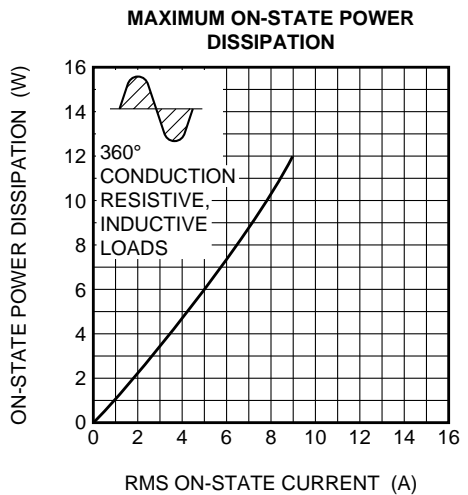
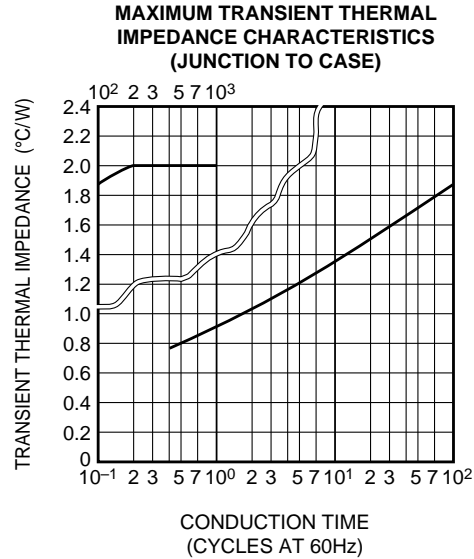
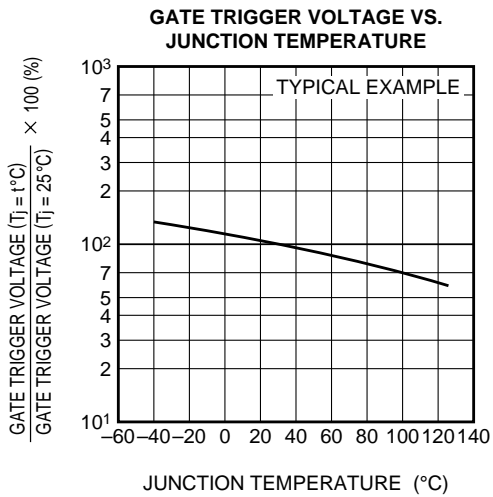
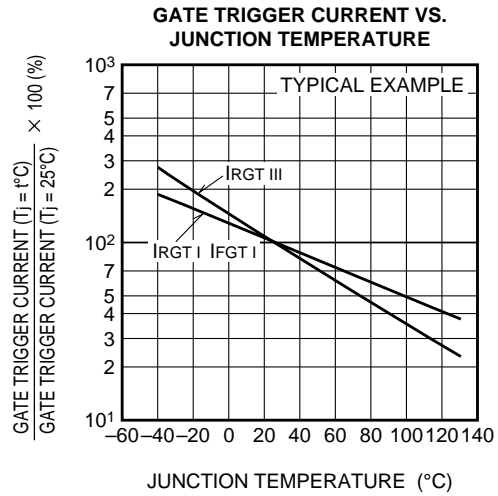
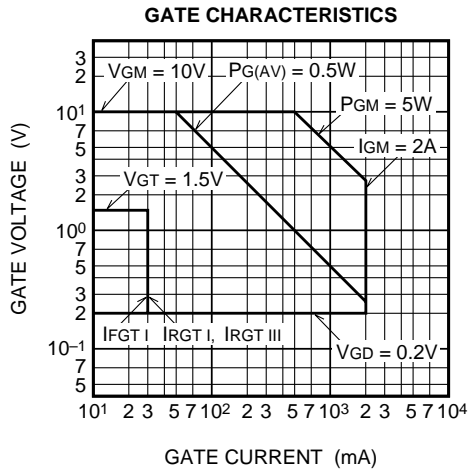

# BCR8CM

MEDIUM POWER USE

NON-INSULATED TYPE, PLANAR PASSIVATION TYPE

**ALLOWABLE AMBIENT TEMPERATURE VS. RMS ON-STATE CURRENT**

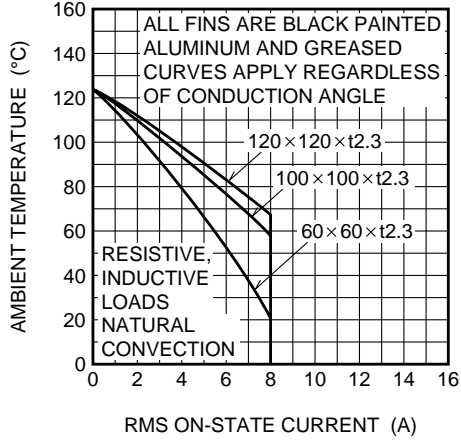

**ALLOWABLE AMBIENT TEMPERATURE VS. RMS ON-STATE CURRENT**

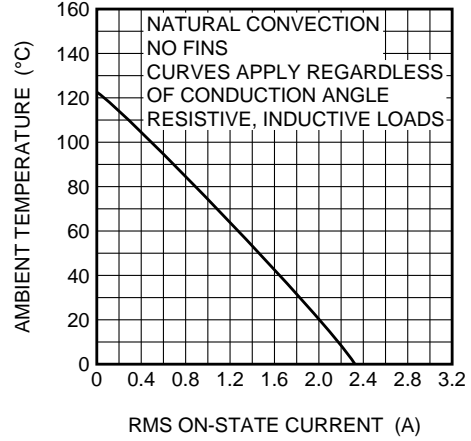

**REPETITIVE PEAK OFF-STATE CURRENT VS. JUNCTION TEMPERATURE**

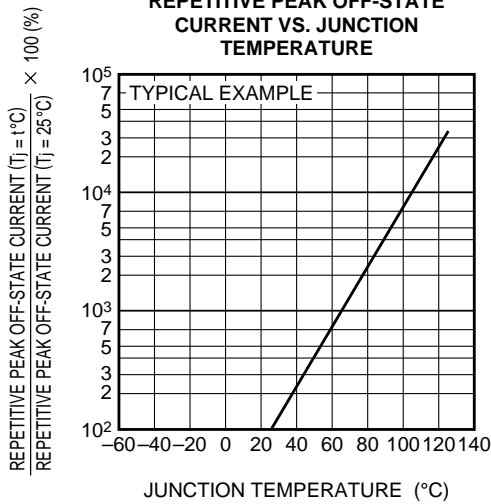

**HOLDING CURRENT VS. JUNCTION TEMPERATURE**

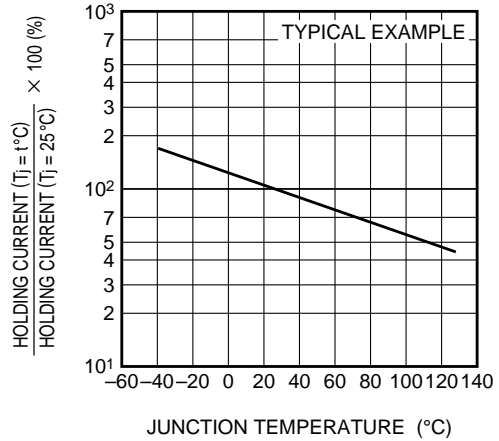

**LATCHING CURRENT VS. JUNCTION TEMPERATURE**

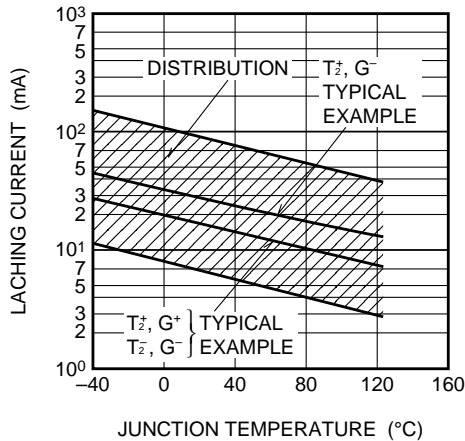

**BREAKOVER VOLTAGE VS. JUNCTION TEMPERATURE**

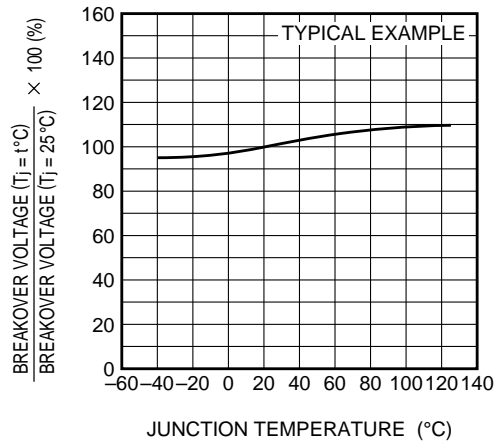

# BCR8CM

MEDIUM POWER USE

NON-INSULATED TYPE, PLANAR PASSIVATION TYPE

**BREAKOVER VOLTAGE VS. RATE OF RISE OF OFF-STATE VOLTAGE**

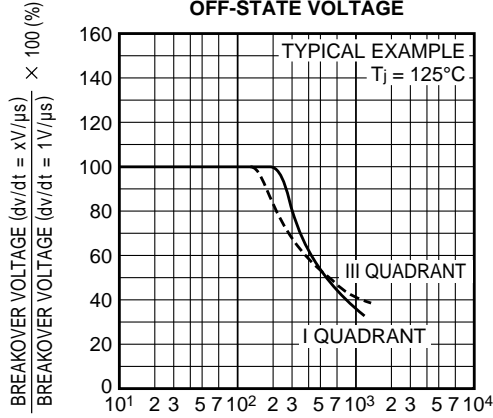

RATE OF RISE OF OFF-STATE VOLTAGE (V/μs)

**COMMUTATION CHARACTERISTICS**

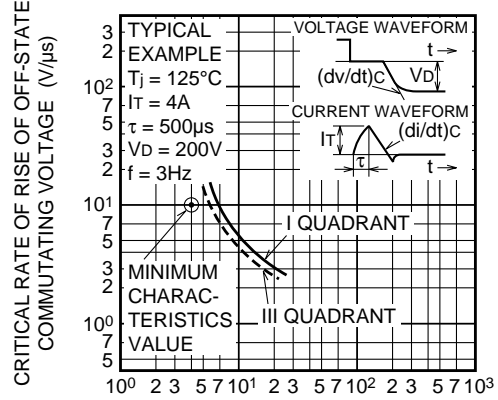

RATE OF DECAY OF ON-STATE COMMUTATING CURRENT (A/ms)

**GATE TRIGGER CURRENT VS. GATE CURRENT PULSE WIDTH**

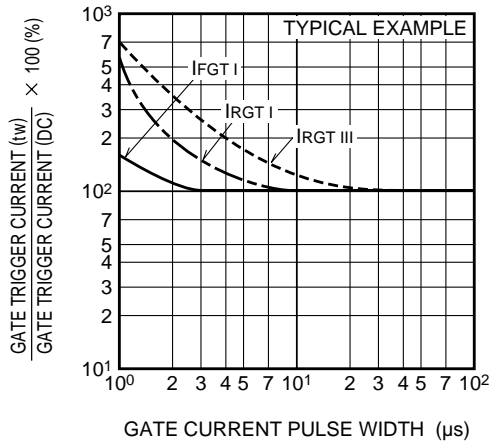

GATE CURRENT PULSE WIDTH (μs)

**GATE TRIGGER CHARACTERISTICS TEST CIRCUITS**

