

Three phase full Bridge

with Trench MOSFETs
in DCB isolated high current package

$V_{DSS} = 100\text{ V}$
 $I_{D25} = 90\text{ A}$
 $R_{DSon\ typ.} = 7.5\text{ m}\Omega$

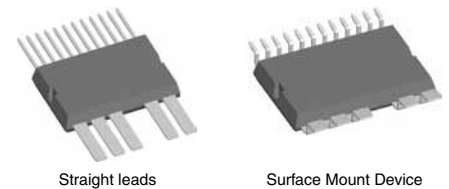
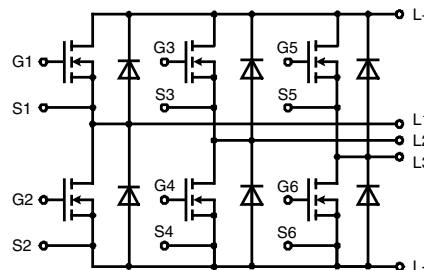

MOSFETs		Maximum Ratings	
Symbol	Conditions		
V_{DSS}	$T_J = 25^\circ\text{C to } 150^\circ\text{C}$	100	V
V_{GS}		± 20	V
I_{D25}	$T_C = 25^\circ\text{C}$	90	A
I_{D90}	$T_C = 90^\circ\text{C}$	68	A
I_{F25}	$T_C = 25^\circ\text{C (diode)}$	90	A
I_{F90}	$T_C = 90^\circ\text{C (diode)}$	68	A

Applications

- AC drives
- in automobiles
 - electric power steering
 - starter generator
 - in industrial vehicles
 - propulsion drives
 - fork lift drives
 - in battery supplied equipment

Features

- MOSFETs in trench technology:
 - low R_{DSon}
 - optimized intrinsic reverse diode
- package:
 - high level of integration
 - high current capability 300 A max.
 - aux. terminals for MOSFET control
 - terminals for soldering or welding connections
 - isolated DCB ceramic base plate with optimized heat transfer
- Space and weight savings

Symbol	Conditions	Characteristic Values			
		min.	typ.	max.	
$(T_J = 25^\circ\text{C, unless otherwise specified})$					
$R_{DSon}^{1)}$	on chip level at $V_{GS} = 10\text{ V}; I_D = 80\text{ A}$		7.5 14	8.5	$\text{m}\Omega$ $\text{m}\Omega$
		$T_J = 25^\circ\text{C}$			
		$T_J = 125^\circ\text{C}$			
$V_{GS(th)}$	$V_{DS} = 20\text{ V}; I_D = 250\ \mu\text{A}$	2.5		4.5	V
I_{DSS}	$V_{DS} = V_{DSS}; V_{GS} = 0\text{ V}$		0.1	1	μA mA
		$T_J = 25^\circ\text{C}$			
		$T_J = 125^\circ\text{C}$			
I_{GSS}	$V_{GS} = \pm 20\text{ V}; V_{DS} = 0\text{ V}$			0.2	μA
Q_g	$V_{GS} = 10\text{ V}; V_{DS} = 65\text{ V}; I_D = 90\text{ A}$		90		nC
Q_{gs}			30		nC
Q_{gd}			30		nC
$t_{d(on)}$	inductive load $V_{GS} = 10\text{ V}; V_{DS} = 48\text{ V}$ $I_D = 70\text{ A}; R_G = 33\ \Omega;$ $T_J = 125^\circ\text{C}$		130		ns
t_r			95		ns
$t_{d(off)}$			290		ns
t_f			55		ns
E_{on}			0.4		mJ
E_{off}			0.4		mJ
E_{recoff}		0.007		mJ	
R_{thJC}			1.0		K/W
R_{thJH}	with heat transfer paste (IXYS test setup)		1.3	1.6	K/W

¹⁾ $V_{DS} = I_D \cdot (R_{DS(on)} + 2R_{Pin\ to\ chip})$

Package options

- 2 lead frames available
 - straight leads (SL)
 - SMD lead version (SMD)

Source-Drain Diode

Symbol	Conditions	Characteristic Values			
		min.	typ.	max.	
(T _J = 25°C, unless otherwise specified)					
V _{SD}	(diode) I _F = 70 A; V _{GS} = 0 V		0.9	1.2	V
t _{rr}	I _F = 70 A; -di _F /dt = 800 A/μs; V _R = 48 V		55		ns
Q _{RM}			0.95		μC
I _{RM}			33		A

Component

Symbol	Conditions	Maximum Ratings	
I _{RMS}	per pin in main current paths (P+, N-, L1, L2, L3) may be additionally limited by external connections	300	A
T _J		-55...+175	°C
T _{stg}		-55...+125	°C
V _{ISOL}	I _{ISOL} ≤ 1 mA, 50/60 Hz, f = 1 minute	1000	V~
F _c	mounting force with clip	50 - 250	N

Symbol	Conditions	Characteristic Values		
		min.	typ.	max.
R _{pin to chip} ¹⁾			0.6	mΩ
C _p	coupling capacity between shorted pins and mounting tab in the case		160	pF
Weight			25	g

¹⁾ V_{DS} = I_D · (R_{DS(on)} + 2R_{Pin to Chip})

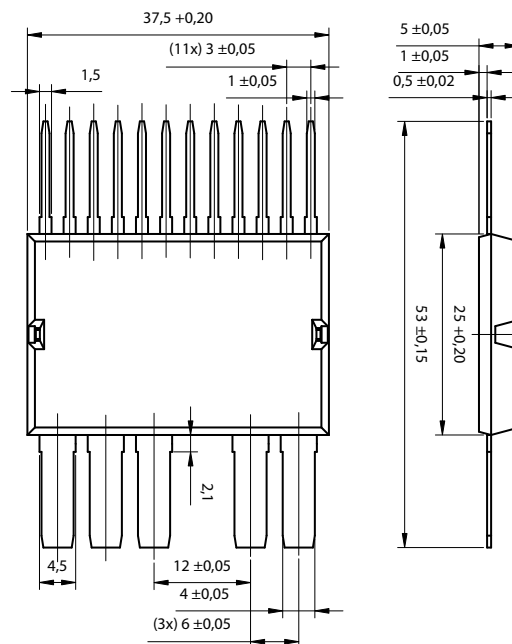
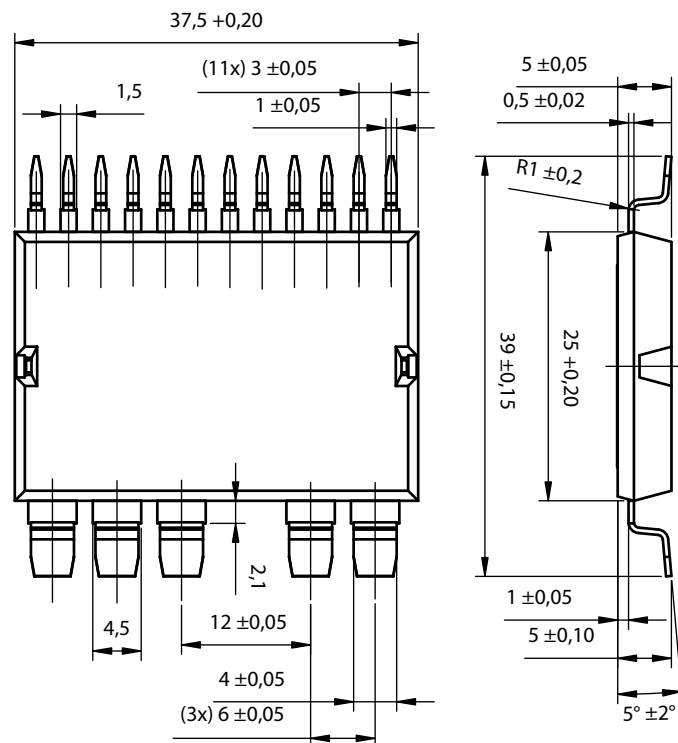
Straight Leads GWM 100-01X1-SL

Surface Mount Device GWM 100-01X1-SMD

Leads	Ordering	Part Name & Packing Unit Marking	Part Marking	Delivering Mode	Base Qty.	Ordering Code
Straight	Standard	GWM 100-01X1 - SL	GWM 100-01X1	Blister	28	505 535
SMD	Standard	GWM 100-01X1 - SMD	GWM 100-01X1	Blister	28	505 542

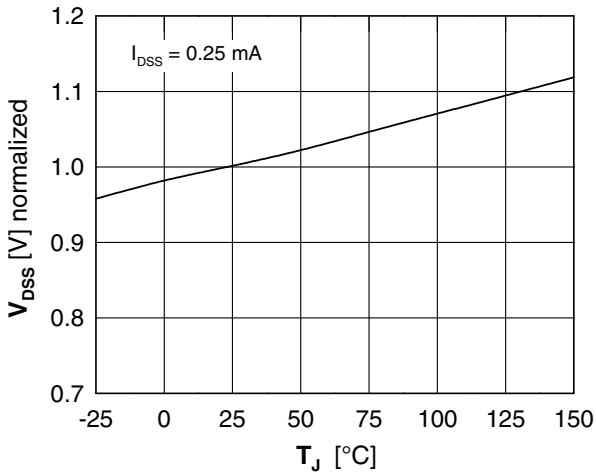

Fig. 1 Drain source breakdown voltage V_{DSS} vs. junction temperature T_J

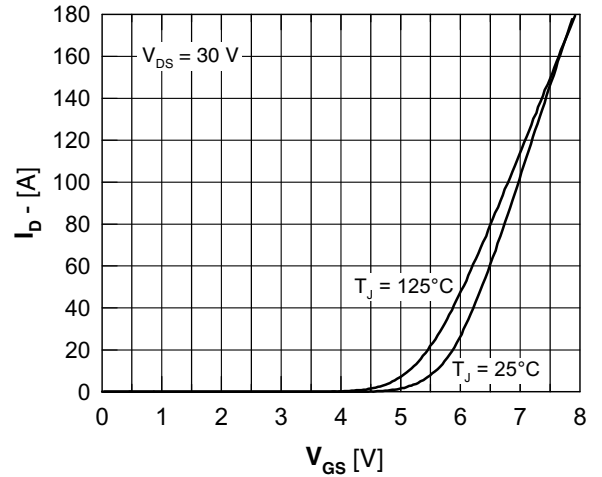

Fig. 2 Typical transfer characteristic

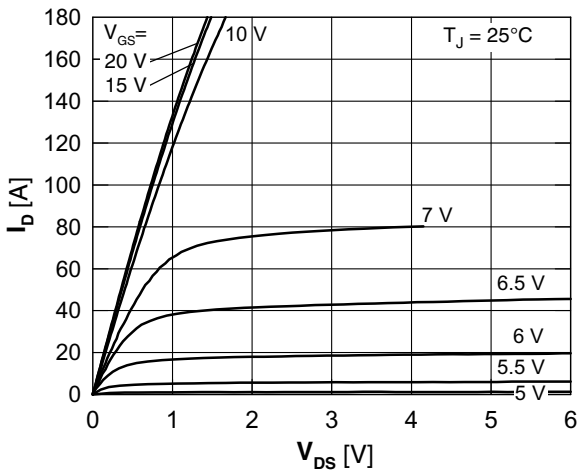

Fig. 3 Typical output characteristic

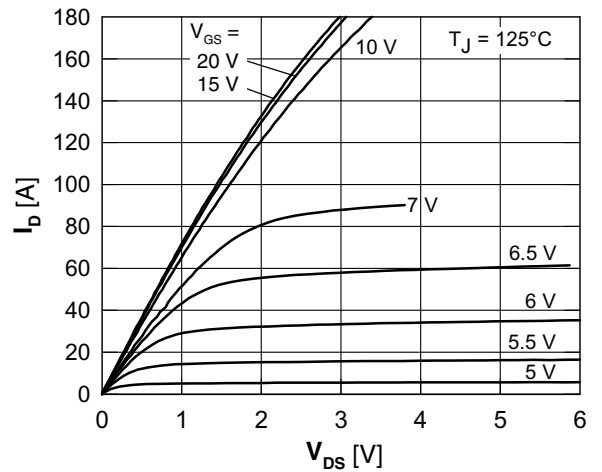

Fig. 4 Typical output characteristic

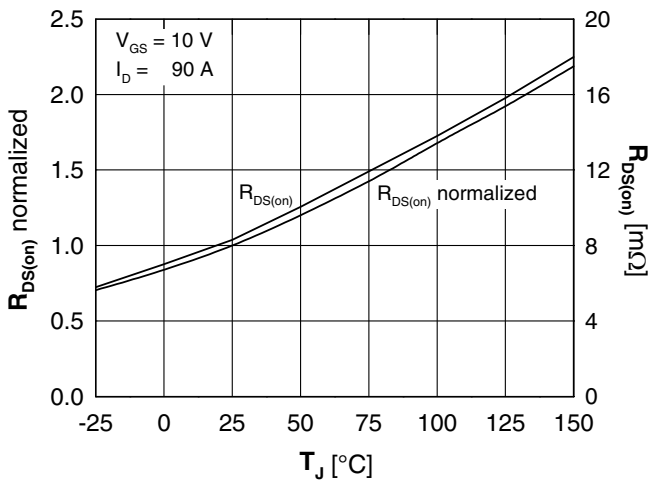

Fig. 5 Drain source on-state resistance $R_{DS(on)}$ versus junction temperature T_J

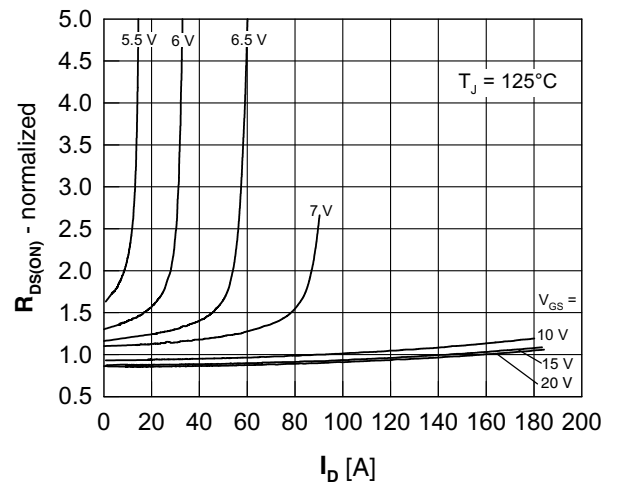

Fig. 6 Drain source on-state resistance $R_{DS(on)}$ versus I_D

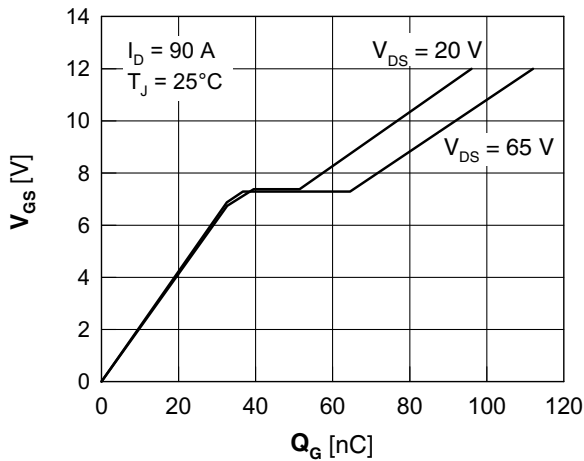

Fig. 7 Gate charge characteristic

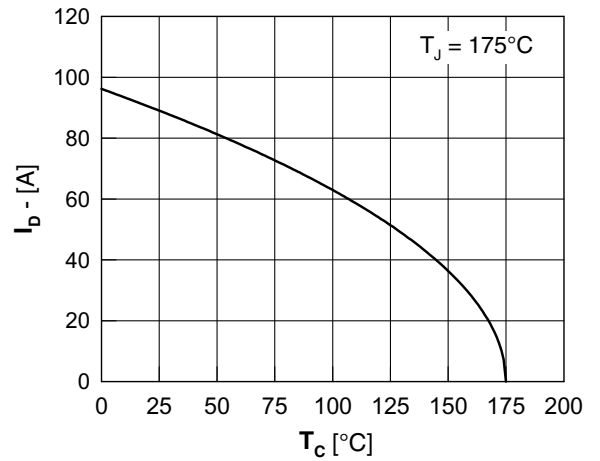

Fig. 8 Drain current I_D vs. case temperature T_c

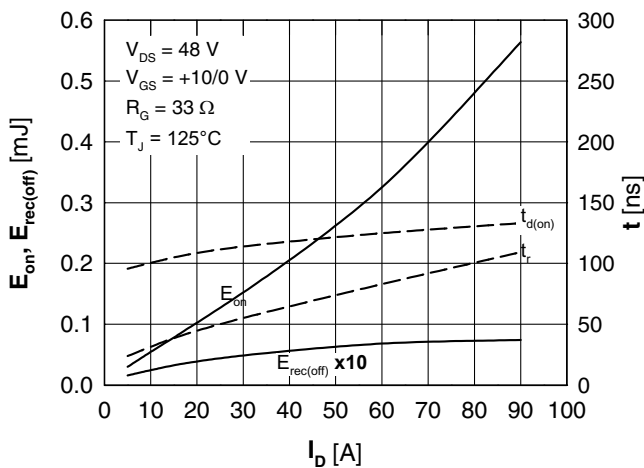

Fig. 9 Typ. turn-on energy & switching times vs. collector current, inductive switching

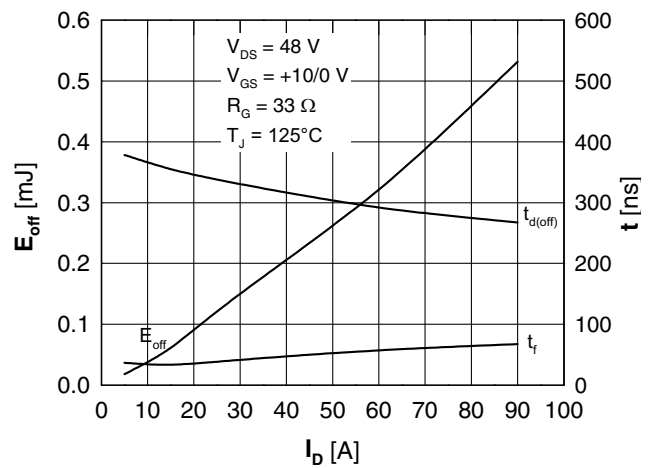

Fig. 10 Typ. turn-off energy & switching times vs. collector current, inductive switching

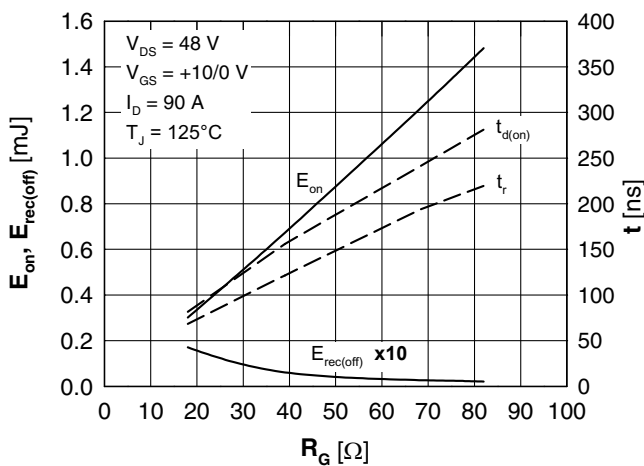

Fig. 11 Typ. turn-on energy & switching times vs. gate resistor, inductive switching

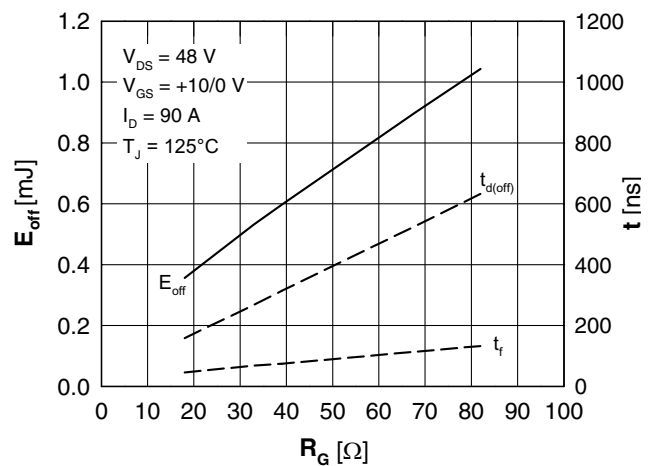

Fig. 12 Typ. turn-off energy & switching times vs. gate resistor, inductive switching

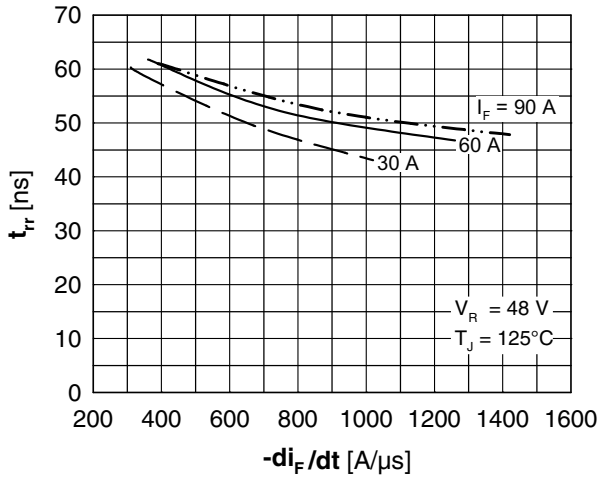

Fig. 13 Reverse recovery time t_{rr} of the body diode vs. di/dt

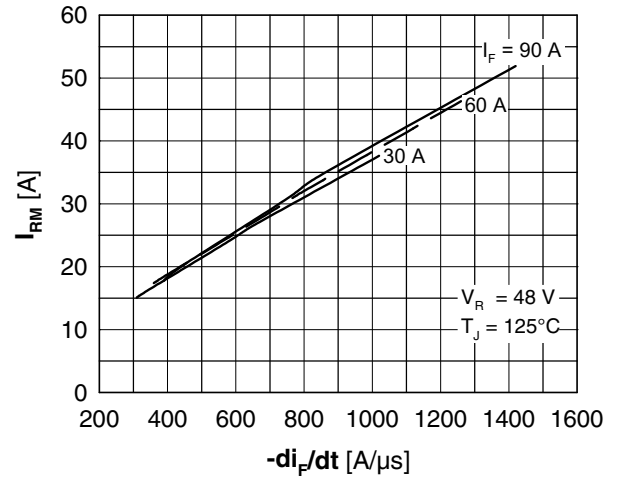

Fig. 14 Reverse recovery current I_{RM} of the body diode vs. di/dt

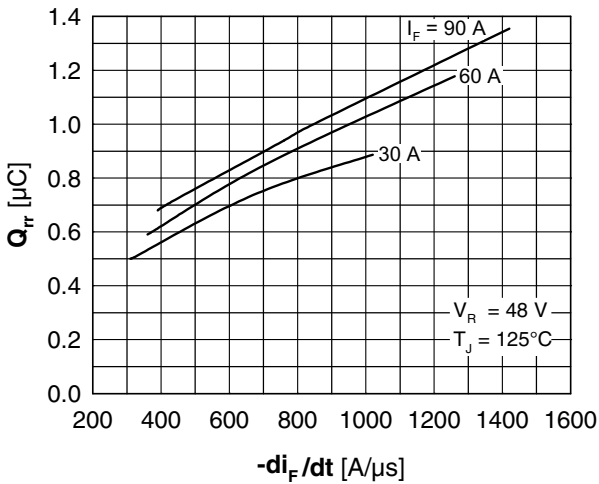

Fig. 15 Reverse recovery charge Q_{rr} of the body diode vs. di/dt

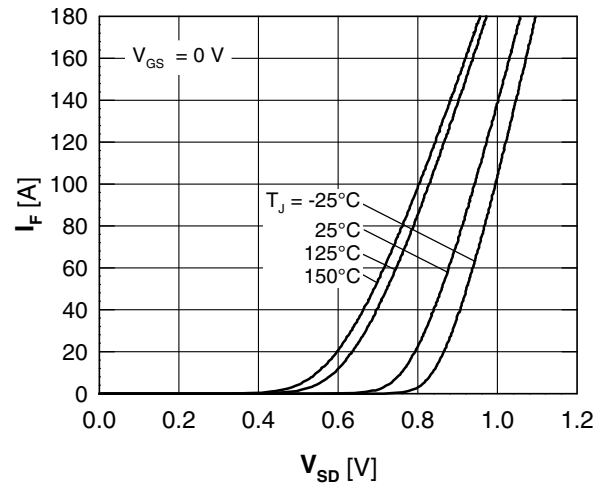

Fig. 16 Source drain diode current I_F vs. source drain voltage V_{SD} (body diode)

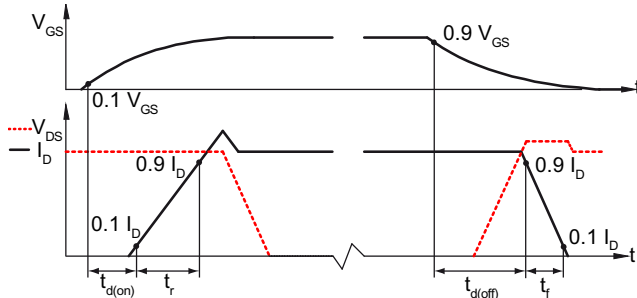

Fig. 17 Definition of switching times

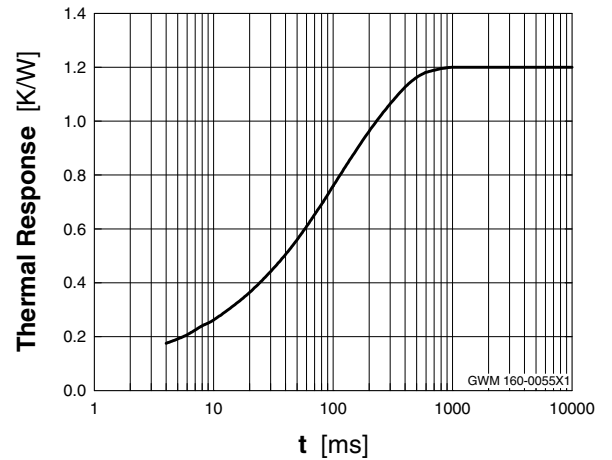

Fig. 18 Typ. thermal impedance junction to heatsink Z_{thJH} with heat transfer paste