

Polymer PTC Resettable Fuse : KMC Series

SMD Type



■ Features

1. RoHS compliant
2. EIA size:1206~1812
3. Hold current ratings from 0.05 to 3A
4. Voltage ratings from 6V computer and electronic applications to 60V
5. Small footprint
6. Fast time to trip
7. Low resistance
8. Operating temperature range : -40~+85°C

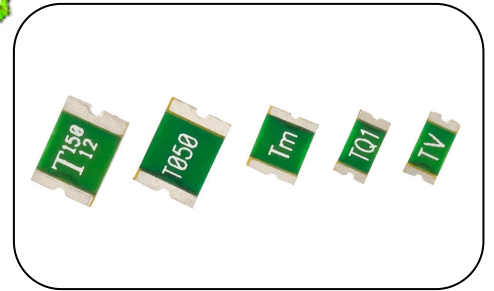

■ Recommended Applications

1. Computer and peripherals
2. Mobile phone battery packs
3. Automobiles
4. Power supplies
5. Telecommunication

■ Part Number Code

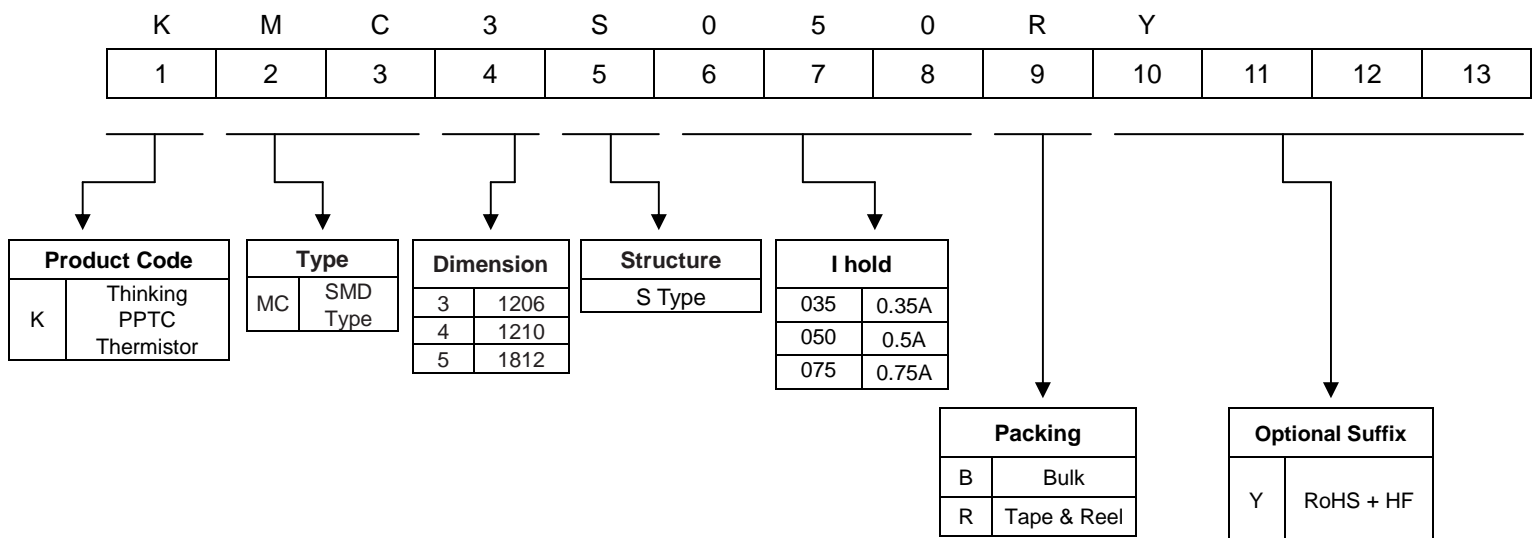

Polymer PTC Resettable Fuse : KMC Series

SMD Type



■ Structure & Dimensions

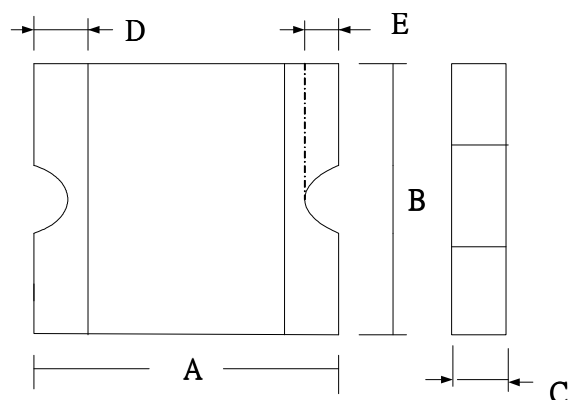

(Unit: mm)

Part No.	A		B		C	D	E	
	(Min.)	(Max.)	(Min.)	(Max.)	(Max.)	(Min.)	(Min.)	(Max.)
KMC3S005	3.00	3.50	1.50	1.80	1.45	0.20	0.10	0.45
KMC3S010					1.45			
KMC3S012					1.45			
KMC3S016					1.45			
KMC3S020					1.10			
KMC3S025					1.00			
KMC3S035					0.75			
KMC3S050					0.75			
KMC35050-15					1.25			
KMC3S075					0.85			
KMC3S100					1.10			
KMC3S110					1.10			
KMC3S150					1.40			
KMC3S200					1.60			
KMC4S005					3.00			
KMC4S010	1.30							
KMC4S020	1.10							
KMC4S035	0.85							
KMC4S050	0.85							
KMC4S075	0.85							
KMC4S110	1.30							
KMC4S150	1.80							
KMC4S175	1.80							

Polymer PTC Resettable Fuse : KMC Series

SMD Type



■ Structure & Dimensions

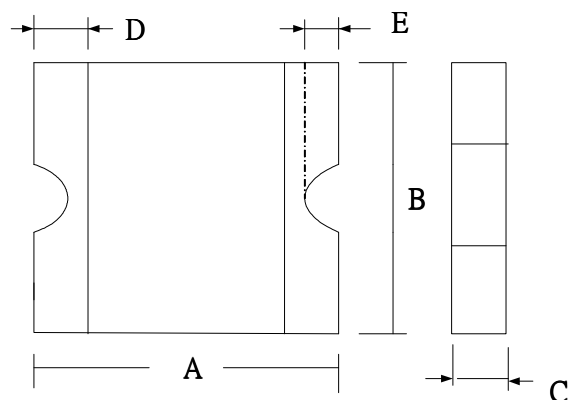

(Unit: mm)

Part No.	A		B		C	D	E	
	(Min.)	(Max.)	(Min.)	(Max.)	(Max.)	(Min.)	(Min.)	(Max)
KMC5S010	4.37	4.73	3.07	3.41	1.30	0.30	0.20	0.65
KMC5S014					1.25			
KMC5S020					1.10			
KMC5S035					0.90			
KMC5S050					0.75			
KMC5S075					0.75			
KMC5S075-24					1.55			
KMC5S075-33					1.55			
KMC5S110					0.73			
KMC5S110-16					1.25			
KMC5S110-24					1.60			
KMC5S110-33					2.00			
KMC5S125-16					1.25			
KMC5S125					0.75			
KMC5S150					0.73			
KMC5S150-12					1.25			
KMC5S150-24					1.80			
KMC5S160					0.75			
KMC5S200					1.20			
KMC5S260					1.34			
KMC5S300	1.55							

Polymer PTC Resettable Fuse : KMC Series



SMD Type

■ Electrical Characteristics(23°C)

Part No.	Vmax.	Imax.	Ihold @ 23°C	Itrip @ 23°C	Pd (Max.)	Maximum Time to Trip		Resistance @ 23°C (Ω)		Safety Approvals		
						Current	Time	Initial (Min.Ri)	Post trip (Max.R1)			
	(V _{DC})	(A)	(A)	(A)	(W)	(A)	(Sec.)	(Ω)	(Ω)	UL	cUL	TUV
KMC3S005	60	100	0.05	0.15	0.4	0.25	1.5	3.6	50	✓	✓	✓
KMC3S010	60	100	0.10	0.25	0.4	0.50	1.0	1.6	15	✓	✓	✓
KMC3S012	30	100	0.125	0.29	0.5	1	0.2	1.4	6	✓	✓	✓
KMC3S016	30	100	0.16	0.37	0.5	1	0.3	1.1	4.5	✓	✓	✓
KMC3S020	24	100	0.20	0.42	0.6	8	0.1	0.65	2.6	✓	✓	✓
KMC3S025	16	100	0.25	0.50	0.6	8	0.08	0.55	2.3	✓	✓	✓
KMC3S035	16	100	0.35	0.75	0.6	8	0.1	0.3	1.2	✓	✓	✓
KMC3S050	6	100	0.50	1.00	0.6	8	0.1	0.15	0.7	✓	✓	✓
KMC35050-15	15	100	0.50	1.00	0.6	8	0.1	0.15	0.7	✓	✓	✓
KMC3S075	6	100	0.75	1.50	0.6	8	0.2	0.1	0.29	✓	✓	✓
KMC3S100	6	100	1.00	1.80	0.8	8	0.3	0.065	0.21	✓	✓	✓
KMC3S110	6	100	1.10	2.20	0.8	8	0.3	0.07	0.2	✓	✓	✓
KMC3S150	6	100	1.50	3.00	0.8	8	1	0.04	0.12	✓	✓	✓
KMC3S200	6	100	2.00	3.50	1	8	1.5	0.02	0.08	✓	✓	✓
KMC4S005	30	10	0.05	0.15	0.6	0.25	1.5	3.6	50	✓	✓	✓
KMC4S010	30	10	0.10	0.30	0.6	0.5	1.5	1.6	15	✓	✓	✓
KMC4S020	30	10	0.20	0.40	0.6	8	0.02	0.8	5	✓	✓	✓
KMC4S035	6	100	0.35	0.70	0.6	8	0.2	0.32	1.3	✓	✓	✓
KMC4S050	13.2	100	0.50	1.00	0.6	8	0.1	0.25	0.9	✓	✓	✓
KMC4S075	6	100	0.75	1.50	0.6	8	0.1	0.11	0.4	✓	✓	✓
KMC4S110	6	100	1.10	2.20	0.6	8	0.3	0.06	0.21	✓	✓	✓
KMC4S150	6	100	1.50	3.00	0.8	8	0.5	0.04	0.11	✓	✓	✓
KMC4S175	6	40	1.75	3.50	0.8	8	0.8	0.02	0.08	✓	✓	✓

Polymer PTC Resettable Fuse : KMC Series



SMD Type

■ Electrical Characteristics(23°C)

Part No.	Vmax.	Imax.	Ihold @ 23°C	Itrip @ 23°C	Pd (Max.)	Maximum Time to Trip		Resistance @ 23°C (Ω)		Safety Approvals		
						Current (A)	Time (Ω)	Initial (Min.Ri) (Ω)	Post trip (Max.R1) (Ω)			
	(V _{dc})	(A)	(A)	(A)	(W)					(A)	(Ω)	(Ω)
KMC5S010	30	100	0.10	0.30	0.8	0.5	1.5	1.6	15	✓	✓	✓
KMC5S014	60	10	0.14	0.34	0.8	1.5	0.15	1.5	6	✓	✓	✓
KMC5S020	30	100	0.20	0.40	0.8	8	0.02	0.8	5	✓	✓	✓
KMC5S035	16	100	0.35	0.70	0.8	8	0.1	0.32	1.5	✓	✓	✓
KMC5S050	16	100	0.50	1.00	0.8	8	0.15	0.15	1	✓	✓	✓
KMC5S075	13.2	100	0.75	1.50	0.8	8	0.2	0.11	0.45	✓	✓	✓
KMC5S075-24	24	100	0.75	1.50	0.8	8	0.2	0.11	0.29	✓	✓	✓
KMC5S075-33	33	20	0.75	1.50	0.8	8	0.2	0.11	0.4	✓	✓	✓
KMC5S110	8	100	1.10	2.20	0.8	8	0.3	0.04	0.21	✓	✓	✓
KMC5S110-16	16	100	1.10	2.20	0.8	8	0.5	0.06	0.18	✓	✓	✓
KMC5S110-24	24	20	1.10	2.20	0.8	8	0.5	0.06	0.2	✓	✓	✓
KMC5S110-33	33	20	1.10	2.20	0.8	8	0.5	0.06	0.2	✓	✓	✓
KMC5S125-16	16	100	1.25	2.50	0.8	8	0.4	0.05	0.14	✓	✓	✓
KMC5S125	6	100	1.25	2.50	0.8	8	0.4	0.05	0.14	✓	✓	✓
KMC5S150	8	100	1.50	3.00	0.9	8	0.3	0.04	0.11	✓	✓	✓
KMC5S150-12	12	100	1.50	3.00	0.9	8	0.5	0.04	0.11	✓	✓	✓
KMC5S150-24	24	20	1.50	3.00	0.9	8	1.5	0.04	0.12	✓	✓	✓
KMC5S160	8	100	1.60	3.20	0.8	8	1.0	0.03	0.1	✓	✓	✓
KMC5S200	8	100	2.00	3.50	1.2	8	2.0	0.02	0.06	✓	✓	✓
KMC5S260	6	100	2.60	5.00	1.2	8	2.5	0.015	0.047	✓	✓	✓
KMC5S300	6	100	3.00	5.00	1.2	8	4.0	0.012	0.04	✓	✓	✓

Note : UL&cUL File No. E138827
TUV File No. R50143386

Polymer PTC Resettable Fuse : KMC Series

SMD Type



Typical Time to Trip Curve at 23°C

1206 Series

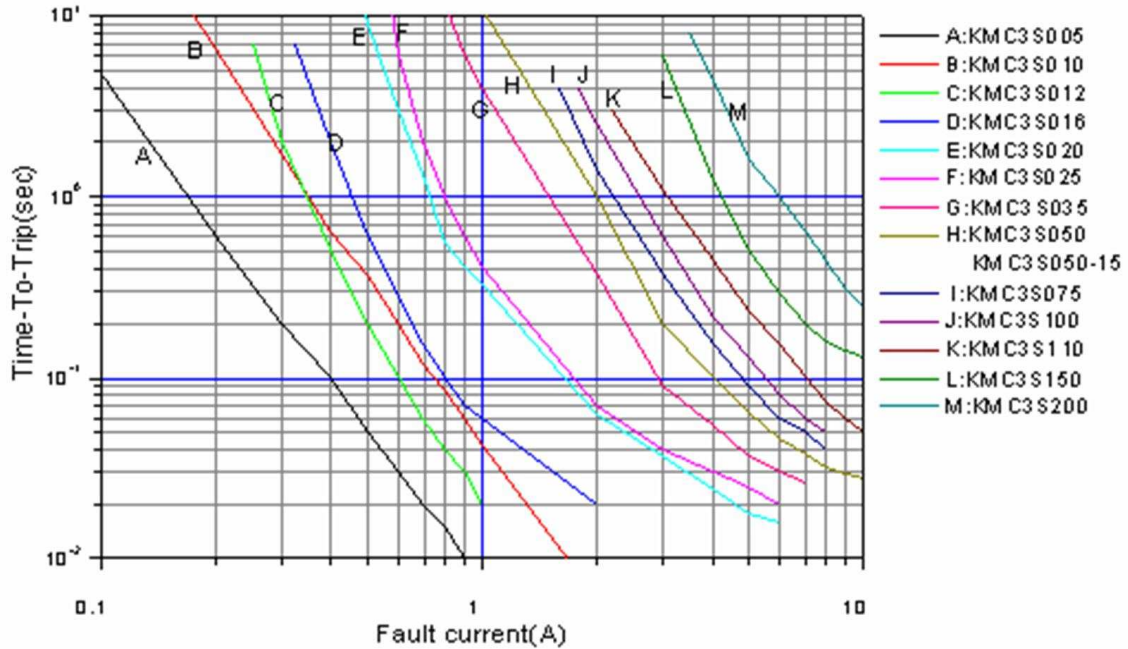

1210 Series

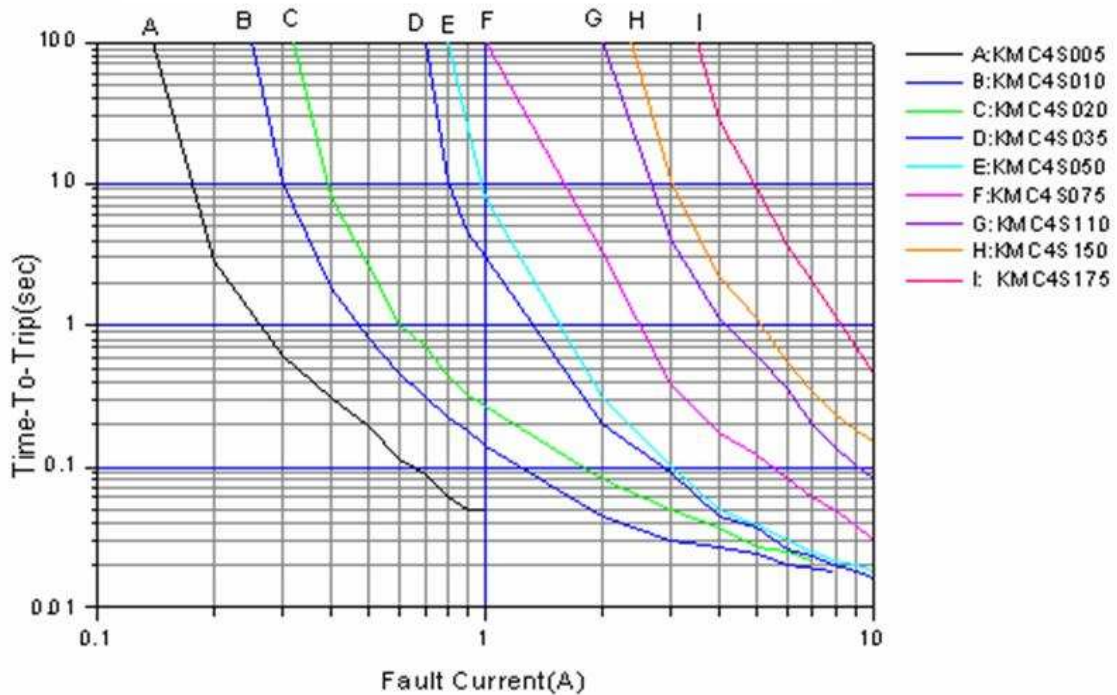

Polymer PTC Resettable Fuse : KMC Series

SMD Type



■ Typical Time to Trip Curve at 23°C

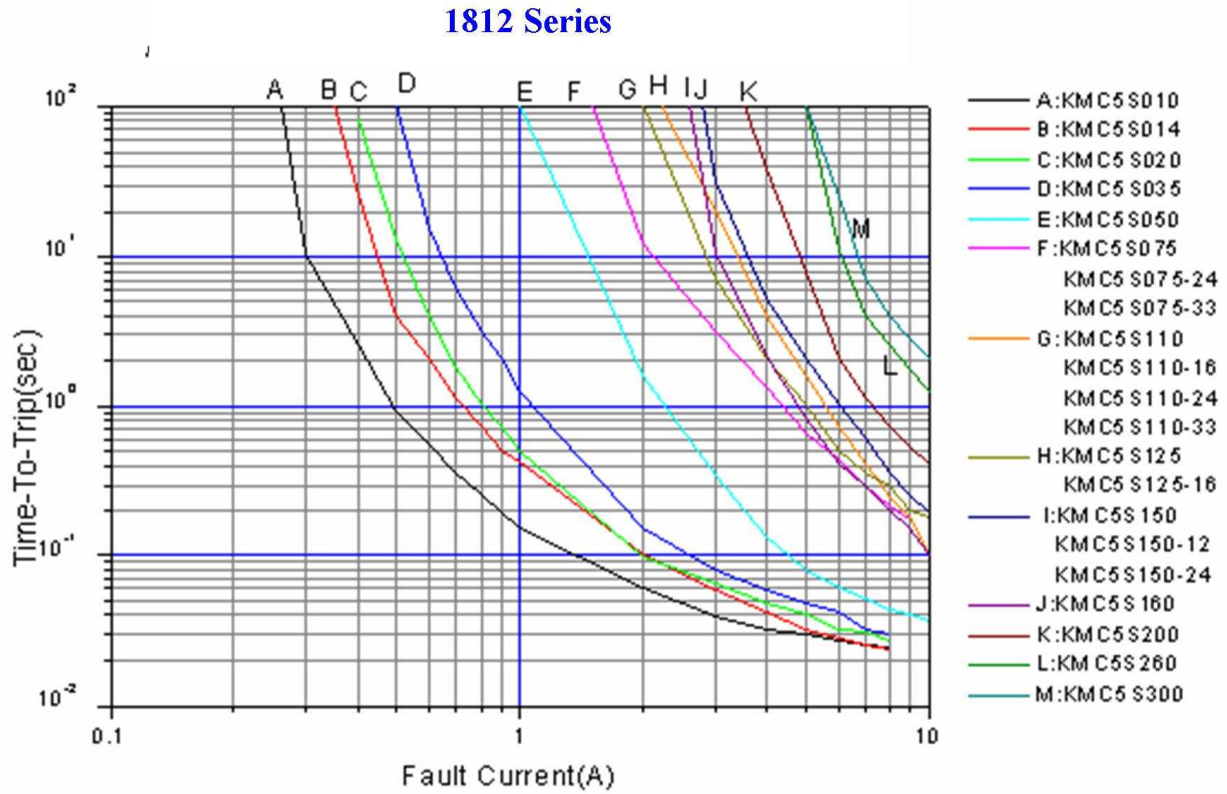

Polymer PTC Resettable Fuse : KMC Series

SMD Type



■ Thermal Derating Chart –Ihold / Itrip (Amps)

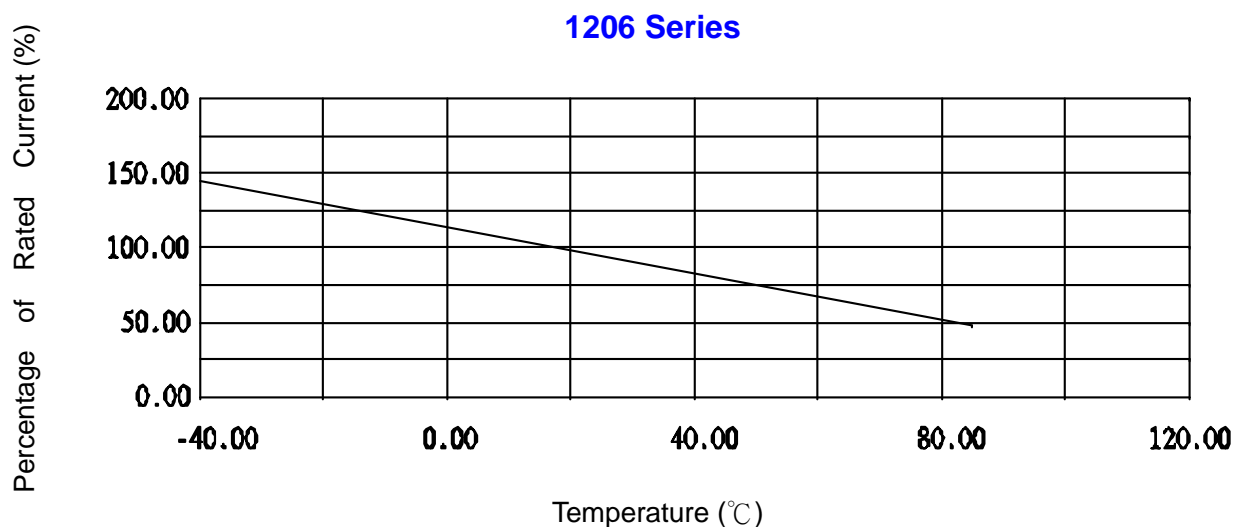

Model	Ambient Operation Temperature								
	-40°C	-20°C	0°C	23°C	40°C	50°C	60°C	70°C	85°C
KMC3S005	0.0725	0.063	0.057	0.05	0.043	0.038	0.035	0.03	0.026
KMC3S010	0.145	0.33	0.115	0.10	0.085	0.075	0.07	0.06	0.055
KMC3S012	0.20	0.17	0.15	0.12	0.11	0.10	0.09	0.08	0.07
KMC3S016	0.21	0.20	0.18	0.16	0.14	0.13	0.12	0.11	0.09
KMC3S020	0.34	0.30	0.26	0.20	0.17	0.15	0.13	0.11	0.08
KMC3S025	0.37	0.33	0.29	0.25	0.22	0.20	0.17	0.15	0.12
KMC3S035	0.50	0.45	0.40	0.35	0.30	0.27	0.24	0.21	0.15
KMC3S050	0.71	0.64	0.57	0.50	0.42	0.39	0.35	0.31	0.25
KMC3S050-15	0.71	0.64	0.57	0.50	0.42	0.39	0.35	0.31	0.25
KMC3S075	1.14	1.01	0.88	0.75	0.65	0.59	0.54	0.49	0.41
KMC3S100	1.45	1.31	1.15	1.00	0.84	0.77	0.69	0.61	0.48
KMC3S110	1.64	1.46	1.30	1.06	0.92	0.83	0.80	0.65	0.52
KMC3S150	2.18	1.94	1.72	1.50	1.28	1.17	1.06	0.96	0.77
KMC3S200	3.56	3.08	2.60	2.00	1.79	1.64	1.50	1.36	1.14

Polymer PTC Resettable Fuse : KMC Series

SMD Type



■ Thermal Derating Chart –Ihold / Itrip (Amps)

1210 Series

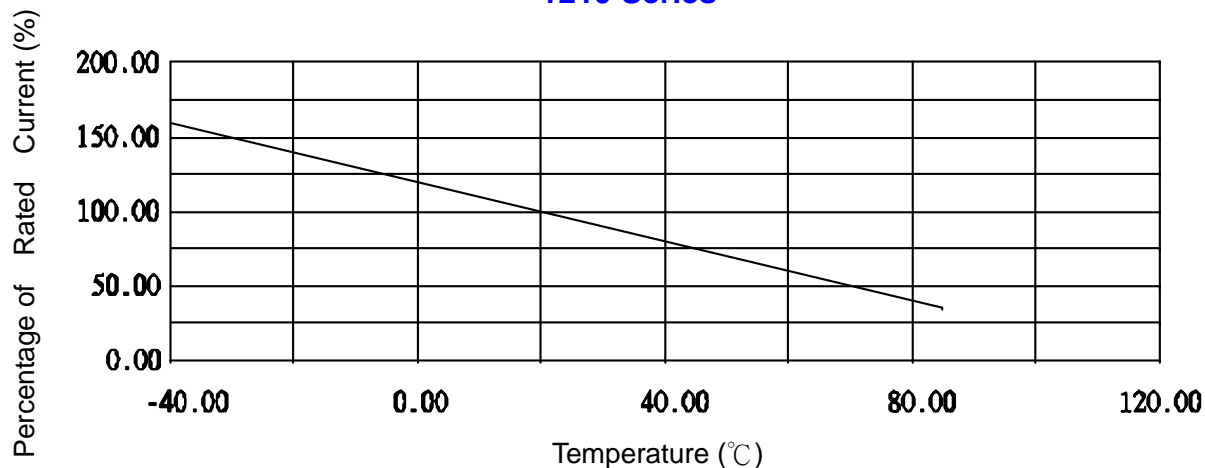

Model	Ambient Operation Temperature								
	-40°C	-20°C	0°C	23°C	40°C	50°C	60°C	70°C	85°C
KMC4S005	0.08	0.07	0.06	0.05	0.04	0.04	0.03	0.03	0.02
KMC4S010	0.16	0.14	0.12	0.10	0.08	0.07	0.06	0.05	0.03
KMC4S020	0.29	0.26	0.22	0.20	0.16	0.14	0.13	0.11	0.08
KMC4S035	0.47	0.45	0.4	0.35	0.33	0.28	0.24	0.21	0.18
KMC4S050	0.76	0.67	0.58	0.50	0.43	0.40	0.36	0.32	0.28
KMC4S075	1.00	0.97	0.86	0.75	0.64	0.59	0.54	0.48	0.40
KMC4S110	1.69	1.48	1.29	1.10	0.88	0.76	0.65	0.57	0.43
KMC4S150	2.13	1.92	1.71	1.50	1.26	1.14	1.01	0.89	0.71
KMC4S175	2.80	2.45	2.10	1.70	1.55	1.45	1.35	1.25	1.10

Polymer PTC Resettable Fuse : KMC Series

SMD Type



■ Thermal Derating Chart -Ihold/ Itrip(Amps)

1812 Series

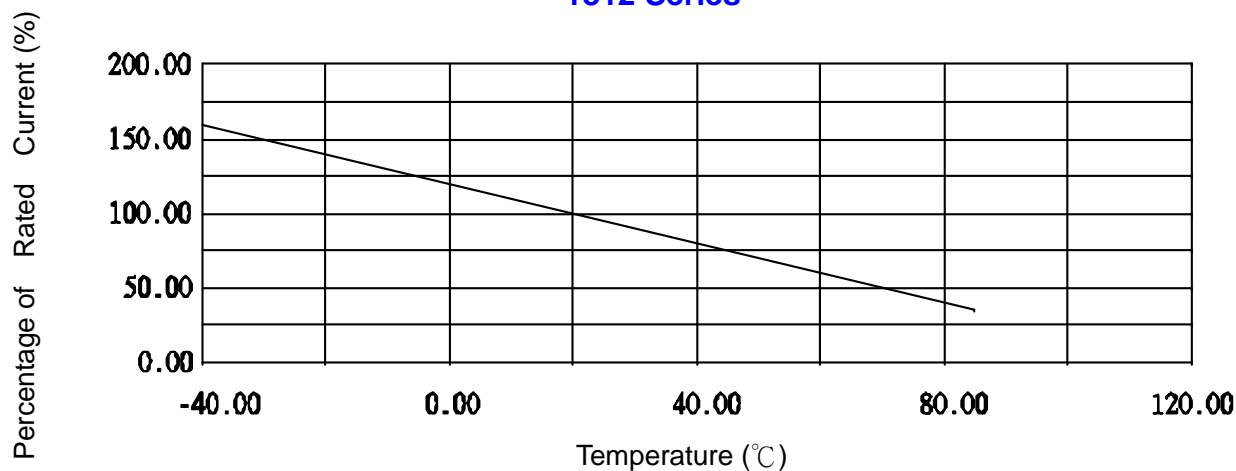

Model	Ambient Operation Temperature								
	-40°C	-20°C	0°C	23°C	40°C	50°C	60°C	70°C	85°C
KMC5S010	0.16	0.14	0.12	0.10	0.08	0.07	0.06	0.05	0.03
KMC5S014	0.23	0.19	0.17	0.14	0.12	0.10	0.09	0.08	0.06
KMC5S020	0.29	0.26	0.23	0.20	0.17	0.15	0.14	0.12	0.10
KMC5S035	0.50	0.45	0.40	0.35	0.29	0.26	0.24	0.21	0.19
KMC5S050	0.77	0.68	0.59	0.50	0.44	0.40	0.37	0.33	0.29
KMC5S075	1.15	1.01	0.88	0.75	0.65	0.60	0.55	0.49	0.43
KMC5S075-24	1.06	0.95	0.84	0.75	0.60	0.55	0.50	0.45	0.37
KMC5S075-33	1.10	1.00	0.88	0.75	0.66	0.60	0.80	0.10	0.60
KMC5S110	1.59	1.43	1.26	1.10	0.95	0.87	0.80	0.71	0.60
KMC5S110-16	1.58	1.43	1.27	1.10	0.95	0.85	0.77	0.71	0.58
KMC5S110-24	1.55	1.40	1.25	1.10	0.93	0.83	0.73	0.63	0.50
KMC5S110-33	1.55	1.40	1.25	1.10	0.93	0.83	0.73	0.63	0.50
KMC5S125	2.00	1.75	1.52	1.25	1.00	0.95	0.90	0.75	0.53
KMC5S125-16	2.00	1.75	1.52	1.25	1.00	0.95	0.90	0.75	0.53
KMC5S150	2.30	2.03	1.76	1.50	1.25	1.10	1.00	0.80	0.76
KMC5S150-12	2.04	1.88	1.68	1.50	1.25	1.10	1.00	0.80	0.60
KMC5S150-24	2.05	1.87	1.67	1.50	1.25	1.08	0.95	0.77	0.60
KMC5S160	2.27	2.05	1.83	1.60	1.35	1.25	1.15	1.00	0.85
KMC5S200	3.08	2.71	2.35	2.00	1.80	1.60	1.50	1.07	0.80
KMC5S260	4.00	3.52	3.06	2.60	2.34	2.08	1.95	1.39	1.04
KMC5S300	4.15	3.76	3.46	3.00	2.55	2.28	2.01	1.61	1.33

Polymer PTC Resettable Fuse : KMC Series

SMD Type



■ Recommended Soldering Condition

● IR-Reflow Soldering Profile

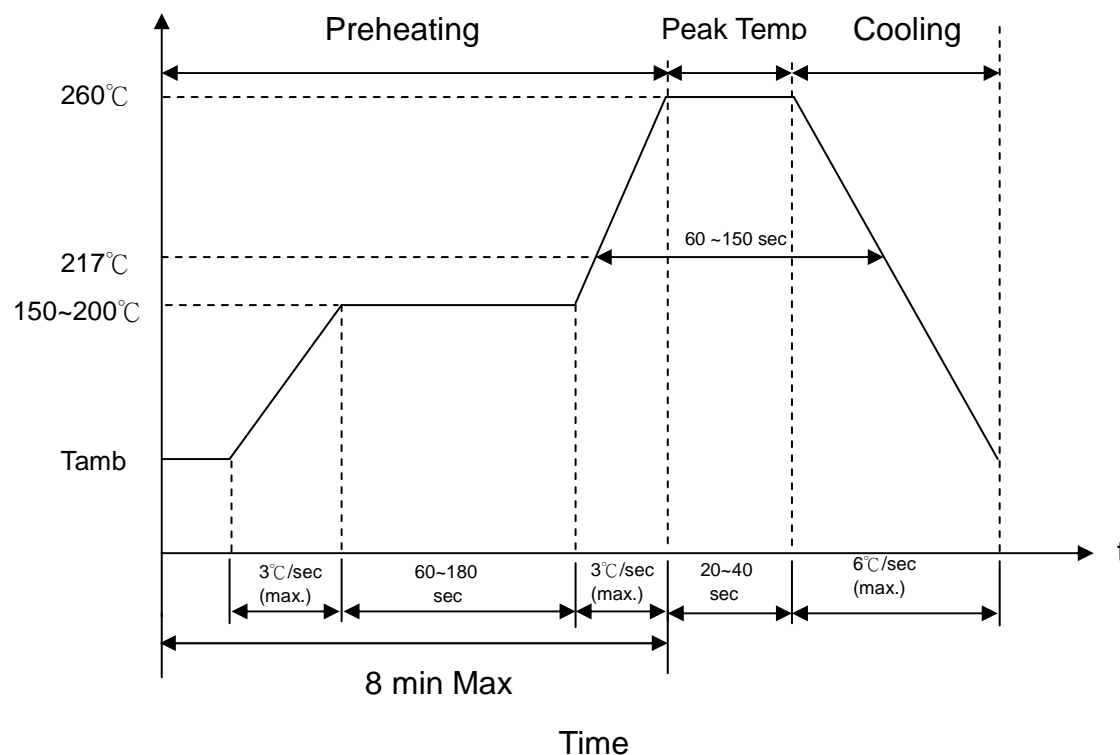

■ Recommended Soldering Pad Dimensions (Nominal)

Unit : mm			
SIZE	A	B	C
KMC3S	2.00	1.00	1.90
KMC4S	2.00	1.00	2.80
KMC5S	3.45	1.78	3.50

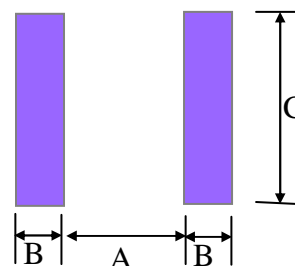

Polymer PTC Resettable Fuse : KMC Series

SMD Type



■ Reliability

Item	Standard	Test conditions/Methods	Specifications
Passive Aging	IEC60738-1	85±5°C , 1000±24hrs	±10% typical resistance change
Humidity Aging	Specification Standard	85±5°C , 80~85%RH, 100±5hrs	±5% typical resistance change
Rapid Change of Temperature	IEC60738-1	85±5/-40±5°C , 20 cycles	-33% typical resistance change
Overload Endurance	UL1434	Vmax,120% I _{max} ,50 cycles + Vmax,300% I _{trip} ,6000 cycles	No arcing or burring
Trip Endurance	UL1434	Vmax, I _{trip} ≤ I ≤ I _{max} , 1000±24hrs	No arcing or burring

Polymer PTC Resettable Fuse : KMC Series

SMD Type



■ Package

● Taping Specification

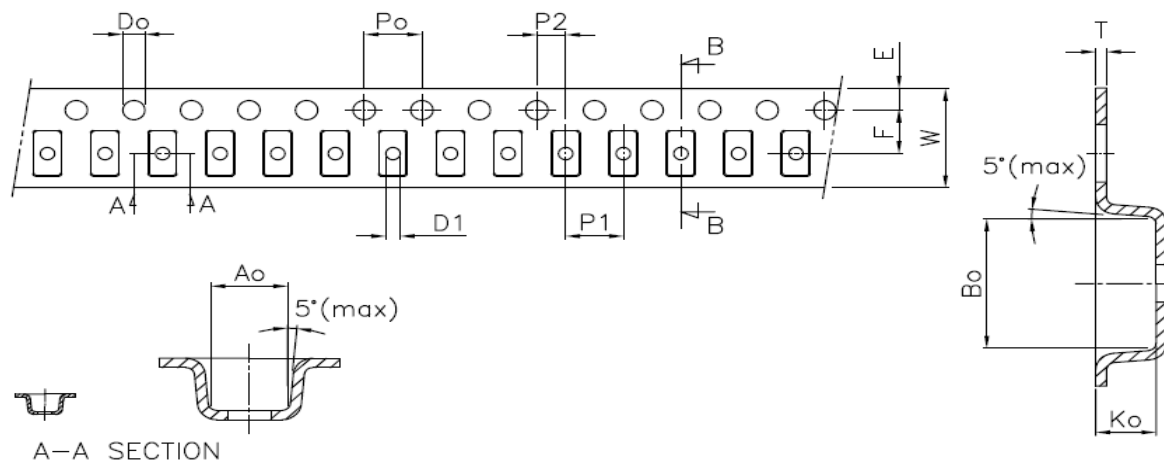

1206 Type

For KMC3S005, KMC3S010, KMC3S050-15, KMC3S100, KMC3S110, KMC3S150, KMC3S200

Index	A0	B0	K0	P0	P1	P2	T	E	F	D0	D1	W	10P0
Type	±0.10	±0.10	±0.10	±0.10	±0.10	±0.05	±0.05	±0.10	±0.05	+0.10/-0	min	±0.10	±0.20
1206	1.95	3.55	1.35	4.0	4.0	2.0	0.25	1.75	3.5	1.50	1.0	8.10	40.0

For KMC3S012, KMC3S016, KMC3S020, KMC3S025, KMC3S035, KMC3S050, KMC3S075

Index	A0	B0	K0	P0	P1	P2	T	E	F	D0	D1	W	10P0
Type	±0.10	±0.10	±0.10	±0.10	±0.10	±0.05	±0.10	±0.10	±0.05	±0.05	min	±0.30	±0.20
1206	1.85	3.45	0.74	4.0	4.0	2.0	0.25	1.75	3.5	1.55	1.0	8.0	40.0

1210 Type

Index	A0	B0	K0	P0	P1	P2	T	E	F	D0	D1	W	10P0
Type	±0.10	±0.10	±0.10	±0.10	±0.10	±0.05	±0.10	±0.10	±0.05	±0.05	min	±0.30	±0.20
1210	2.82	3.50	1.30	4.00	4.00	2.00	0.20	1.75	3.5	1.55	1.0	8.00	40.0

Polymer PTC Resettable Fuse : KMC Series

SMD Type



1812 Type

For KMC5S035, KMC5S050, KMC5S075, KMC5S110, KMC5S125, KMC5S150, KMC5S160, KMC5S200

Index	A0	B0	K0	P0	P1	P2	T	E	F	D0	D1	W	10P0
Type	±0.10	±0.10	±0.06	±0.10	±0.10	±0.05	±0.10	±0.10	±0.05	±0.05	min	±0.30	±0.20
1812	3.58	4.93	0.87	4.00	8.00	2.00	0.25	1.75	5.50	1.55	1.50	12.00	40.0

For KMC5S010, KMC5S014, KMC5S020, KMC5S075-24, KMC5S075-33, KMC5S110-16, KMC5S110-24, KMC5S110-33, KMC5S125-16, KMC5S150-12, KMC5S150-24, KMC5S260, KMC5S300

Index	A0	B0	K0	P0	P1	P2	T	E	F	D0	D1	W	10P0
Type	±0.10	±0.10	±0.10	±0.10	±0.10	±0.05	±0.10	±0.10	±0.05	+0.05	+0.15/-0	±0.30	±0.20
1812	3.56	4.94	1.70	4.00	8.00	2.00	0.25	1.75	5.50	1.55	1.50	12.00	40.0

● Quantity

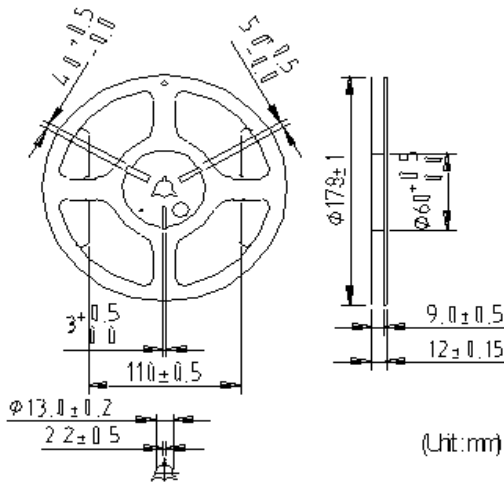

Type	Quantity (pcs/reel)
1206 (For KMC3S012 · KMC3S016 · KMC3S020 · KMC3S025 · KMC3S035 · KMC3S050 · KMC3S075)	5000
1206 (others)	2500
1210	3000

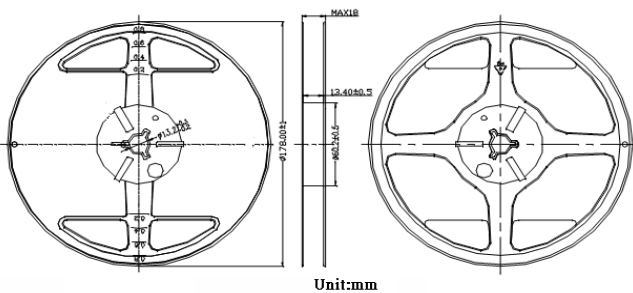

Type	Quantity (pcs/reel)
1812 (For KMC5S035 · KMC5S050 · KMC5S075 · KMC5S110 · KMC5S125 · KMC5S150 · KMC5S160 · KMC5S200)	2000
1812 (others)	1000

Polymer PTC Resettable Fuse : KMC Series



SMD Type

■ Storage Conditions of Products

- Storage Conditions :
 - 1.Storage Temperature : -10 °C ~ + 40 °C
 - 2.Relative humidity : ≤ 75%RH
 - 3.Thermistors must be kept away from sunlight and stored in a non-corrosive atmosphere.
- Period of Storage : 1 year

■ Cross Reference

Size	TKS	Raychem	Polytronics	Bourns	Littelfuse
1206	KMC3S005	-----	-----	-----	-----
	KMC3S010	-----	-----	-----	-----
	KMC3S012	nanoSMDC012F	SMD1206P012TF	MF-NSMF012	1206L 012
	KMC3S016	nanoSMDC016F	SMD1206P016TF	-----	1206L 016
	KMC3S020	nanoSMDC020F	SMD1206P020TF/24	MF-NSMF020	1206L 020-C
	KMC3S025	-----	SMD1206P025TF	-----	1206L 025-C
	KMC3S035	nanoSMDC035F	SMD1206P035TF/16	MF-NSMF035	1206L 035/16
	KMC3S050	-----	SMD1206P050TF	-----	1206L 050-C
	KMC3S050-15	nanoSMDC050F/13.2	SMD1206P050TF/15	MF-NSMF050	1206L 050/15
	KMC3S075	nanoSMDC075F	SMD1206P075TF	MF-NSMF075	1206L 075-C
	KMC3S100	-----	-----	-----	1206L 100
	KMC3S110	nanoSMDC110F	SMD1206P110TF	MF-NSMF110	1206L 110
	KMC3S150	nanoSMDC150F	SMD1206P150TF	MF-NSMF150	1206L 150-C
	KMC3S200	nanoSMDC200F	SMD1206P200TF	MF-NSMF200	-----
1210	KMC4S005	microSMD005F	SMD1210P005TF	MF-USMF 005	1210L005
	KMC4S010	microSMD010F	SMD1210P010TF	MF-USMF 010	1210L010
	KMC4S020	-----	SMD1210P020TF	MF-USMF 020	1210L020
	KMC4S035	microSMD035F	SMD1210P035TF	MF-USMF 035	1210L035
	KMC4S050	microSMD050F	SMD1210P050TF	MF-USMF 050	1210L050
	KMC4S075	microSMD075F	SMD1210P075TF	MF-USMF 075	1210L075
	KMC4S110	microSMD110F	SMD1210P110TFT	MF-USMF 110	1210L110
	KMC4S150	microSMD150F	SMD1210P150TFT	MF-USMF 150	1210L150
	KMC4S175	-----	SMD1210P175TF	MF-USMF 175X	-----

Polymer PTC Resettable Fuse : KMC Series



SMD Type

Size	TKS	Raychem	Polytronics	Bourns	Littelfuse
1812	KMC5S010	-----	SMD1812P010TF	MF-MSMF 010	1812L 010
	KMC5S014	miniSMDC014F	SMD1812P014TF	MF-MSMF 014	1812L 014
	KMC5S020	miniSMDC020F	SMD1812P020TF	MF-MSMF 020	1812L 020
	KMC5S035	-----	-----	-----	-----
	KMC5S050	miniSMDC050F	SMD1812P050TF	MF-MSMF 050	1812L 050-C
	KMC5S075	miniSMDC075F	SMD1812P075TF	MF-MSMF 075	1812L 075-C
	KMC5S075-24	miniSMDC075F/24	SMD1812P075TF/24	MF-MSMF 075/24	1812L 075/24
	KMC5S075-33	-----	SMD1812P075TF/33	-----	1812L 075/33
	KMC5S110	miniSMDC110F	SMD1812P110TF	MF-MSMF 110	1812L 110-C
	KMC5S110-16	miniSMDC110F/16	SMD1812P110TF/16	MF-MSMF 110/16	1812L 110/16
	KMC5S110-24	miniSMDC110F/24	SMD1812P110TF/24	-----	-----
	KMC5S110-33	-----	SMD1812P110TF/33	-----	1812L 110/33
	KMC5S125	miniSMDC125F	SMD1812P125TF/6,4L	MF-MSMF 125	1812L 125/6
	KMC5S125-16	miniSMDC125F/16	SMD1812P125TF/16	-----	1812L 125-C
	KMC5S150	miniSMDC150F	SMD1812P150TF/8	MF-MSMF 150	1812L 150-C
	KMC5S150-12	miniSMDC150F/12	SMD1812P150TF/12	-----	1812L 150/12
	KMC5S150-24	miniSMDC150F/24	SMD1812P150TF/24	MF-MSMF 150/24X	1812L 150/24
	KMC5S160	miniSMDC160F	SMD1812P160TF/8(4L)	MF-MSMF 160	1812L 160-C
	KMC5S200	miniSMDC200F	SMD1812P200TFT	MF-MSMF 200	1812L 200-C
	KMC5S260	miniSMDC260F	SMD1812P260TFT	MF-MSMF 260	1812L 260-C
KMC5S300	-----	SMD1812P300TF	-----	-----	