



Intronics
Power®

IBM PC AT Compatible High Resolution Data Acquisition Board

RTI-850

FEATURES

- 16-Bit A/D Resolution
- 14-Bit Accuracy ($\pm 0.003\%$)
- 8 Differential Analog Input Channels
- 50kHz Throughput into On-Board Memory or System Memory
- 256K \times 16-Bits On-Board Memory
- Software Programmable Random Channel Scan
- Card-to-System Memory DMA Transfer Capability
- Extensive Triggering Modes
 - Pre/Post-Trigger Mode
 - TTL Trigger Input (Rising/Falling Edge)
 - Software Programmable Analog Trigger
 - Analog Trigger from Selected Input Channel
 - Auxiliary Analog Trigger Input
 - Analog Trigger Mode Select:
 - + Slope, - Slope, Level High, Level Low
- Software Programmable Pacer Clock

GENERAL

- Compatible with IBM PC AT* and 100% Compatibles
- Optional Screw Termination Panel (STB-GP) for Remote Signal Termination and Conditioning

SOFTWARE

- Callable MS-DOS Routines for Analog Inputs
- High-Level Languages Supported Include BASIC, PASCAL, C, FORTRAN, and TURBO PASCAL
- Calibration Routines

TYPICAL APPLICATIONS

- Medical Instrumentation
- Analytical Instrumentation
- Precision Machine Control
- Robotics Control
- Test Equipment
- Digital Audio
- Seismic Data Acquisition

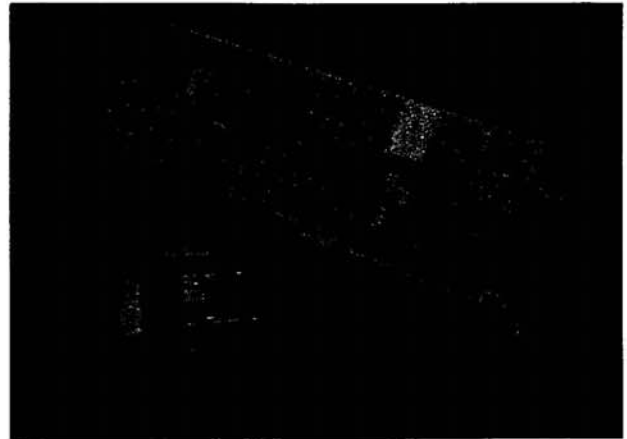

and an accuracy of 14 bits at speeds comparable to most 12-bit boards. In addition, the RTI-850 has a jumper selectable short cycle mode for higher throughputs in applications not requiring full 16-bit resolution.

The RTI-850 has on-board RAM to allow large amounts of data (up to 256K samples) to be acquired at high speeds without intervention of the AT's microprocessor. As a result, an AT-based acquisition system can be used in applications formerly solved only by expensive minicomputers or dedicated instrumentation with large memory storage capability. DMA-based data transfer from the card is also provided for immediate data storage into system memory.

The RTI-850 provides several data acquisition triggering options. Paced A/D conversions may be started via an external TTL signal, a software generated trigger, or an analog voltage value originating from an input channel or an external source. The analog trigger options include a trigger threshold level and multiple select modes (+/- slope, level high, level low). An on-board pacer clock is used to pace the conversions with periods ranging from 1 μ s to 131s. In addition, an external pacer input is provided to allow the RTI-850 timing to be controlled externally.

The RTI-850 is supported by two levels of software: MS-DOS based high-level language drivers and menu-driven application software. Refer to the separate data sheets for more detailed information.

The RTI-850 is a member of the RTI I/O Board Family.

GENERAL DESCRIPTION

The RTI-850 is a high resolution data acquisition board that plugs into one of the expansion slots of the IBM PC AT or equivalent microcomputers. The RTI-850 provides eight channels of differential analog input with an A/D resolution of 16 bits

*IBM PC AT is a trademark of International Business Machines Corp.

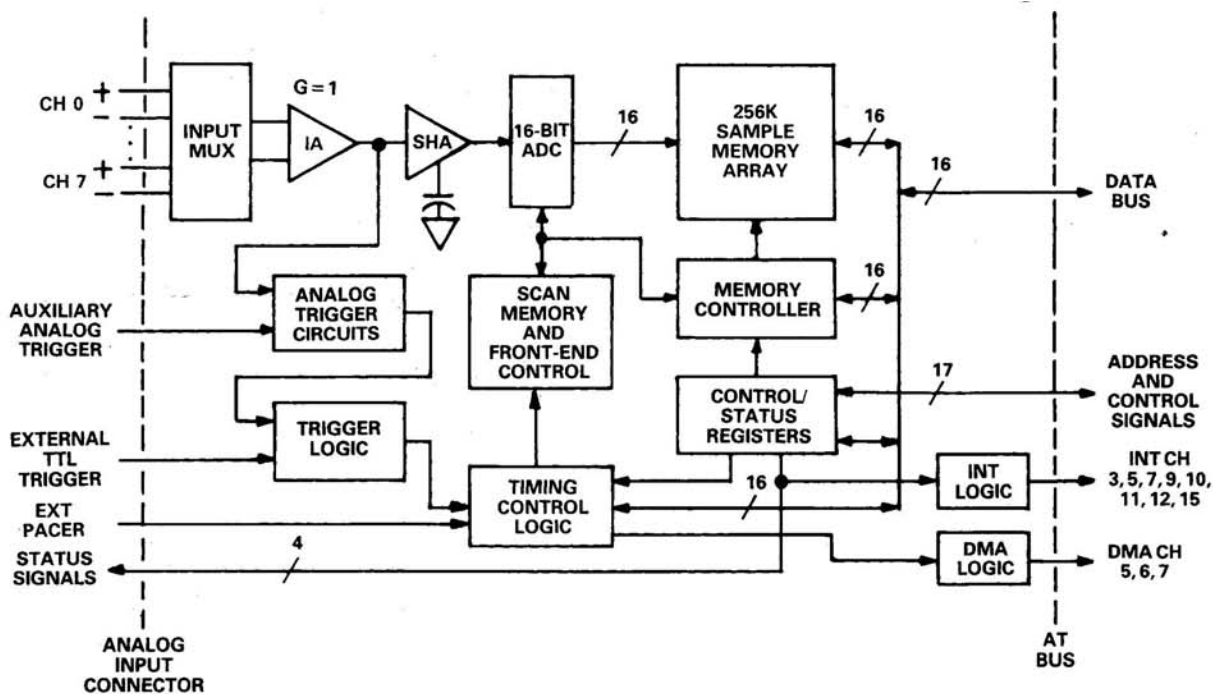

Functional Block Diagram

FUNCTIONAL DESCRIPTION

The RTI-850 provides eight differential analog input channels with 16-bit resolution at a $17\mu\text{s}$ maximum conversion time. The board also provides 15-bit and 14-bit modes (jumper selectable) with $16\mu\text{s}$ and $15\mu\text{s}$ conversion times, respectively, for applications not requiring the full 16-bit resolution. The board provides 14-bit accuracy (0.003% of full-scale range) when used in the 16-bit mode.

The RTI-850 provides multiple triggering options. Paced A/D conversions may be triggered from an externally generated TTL pulse, an analog input voltage value, or an externally generated auxiliary analog voltage value. Once initiated, multiple conversions

may be paced with the on-board counter/timer chip or an externally generated pulse source.

The RTI-850 supports a pre-trigger mode of operation that allows a predefined number of data samples to be stored in a circular buffer prior to receiving a trigger. Once triggered, the card stores subsequent data as post-trigger data.

Acquired data may be stored in local card memory or transferred into system memory via DMA data transfer. Up to 256K 16-bit samples may be stored into on-board memory. In addition, the card supports a continuous data transfer mode that allows one half of an on-board data buffer to be filled while the other half is emptied out into system memory.

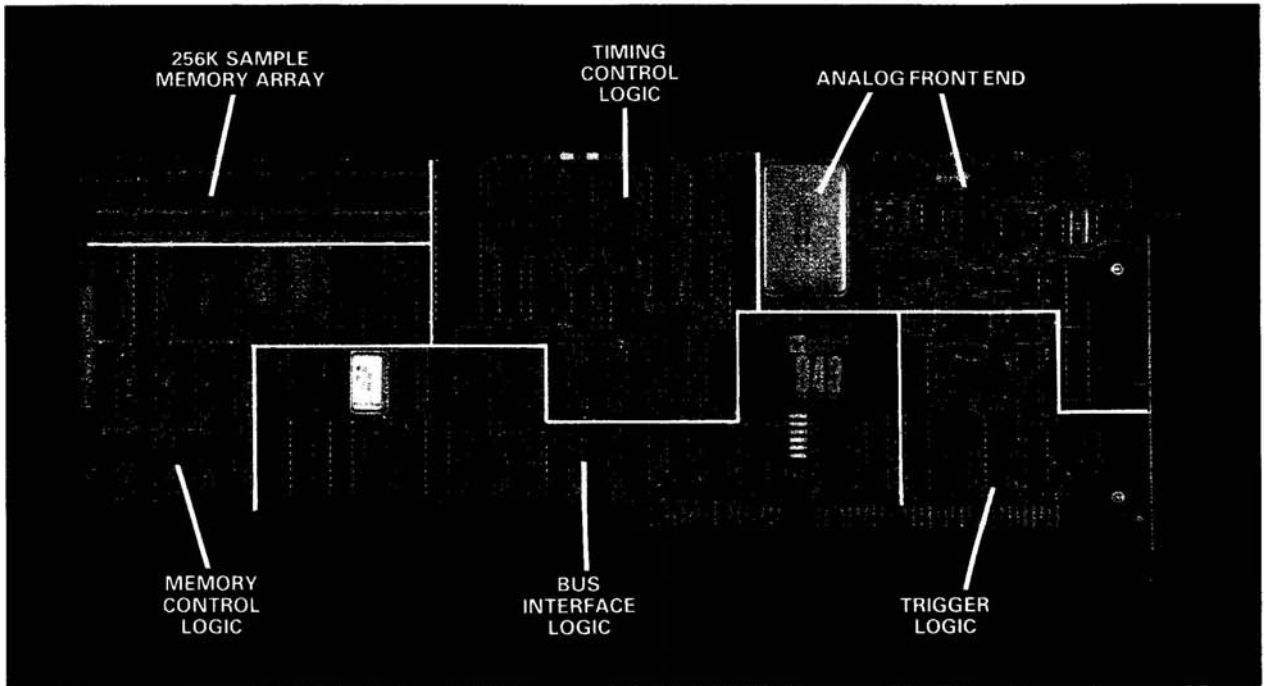

ANALOG INPUT

Two 8:1 analog multiplexers provide 8 protected differential analog inputs with a range of $\pm 10V$. The multiplexer output is fed into a unity gain instrumentation amplifier, followed by a high precision sample-and-hold amplifier (SHA), which in turn feeds into the AD376 high resolution A/D converter. The AD376 is a 16-bit, $17\mu s$ converter with a short cycle option that allows the A/D conversion to be terminated before all of the 16 bits have been converted, resulting in shorter conversion times and, therefore, faster throughputs. The RTI-850 supports a 15-bit and 14-bit short cycle mode.

The RTI-850 uses an overlap scan mode to obtain maximum throughput capability. Analog inputs are read one after the other in a pipelined architecture which overlaps the multiplexer and SHA settling times with the A/D conversion time. This overlapping scheme enables the RTI-850 to achieve throughput rates of 55kHz (14 bits) 52kHz (15 bits), and 50kHz (16 bits) into on-board RAM memory or into the AT's system memory via DMA transfer. An on-board multiplexer memory buffer is also provided for random channel scanning capability, allowing up to 16 input channels, in any sequence, to be scanned by the card.

The RTI-850 has an overall system accuracy of 14 bits when used in the 16-bit mode, or 0.003% of the full-scale range. Input offset and gain potentiometers are provided to allow the gain and offset errors to be trimmed to zero. The board also provides an input impedance of $>10M\Omega$ and a common-mode rejection of 92dB at 0-60Hz.

TRIGGERING

The RTI-850 has the hardware capability to trigger paced A/D conversions from a wide variety of sources. The trigger source may originate from a software source, an external TTL pulse, an analog input voltage value, or an auxiliary analog voltage. Any one of the triggering sources allows paced A/D conversions to be initiated by an external event.

The external TTL trigger selection is edge-triggered by a TTL signal. Through software, the board can be configured to acquire data on receipt of either the rising edge or falling edge of a pulse, as shown in Figure 1.

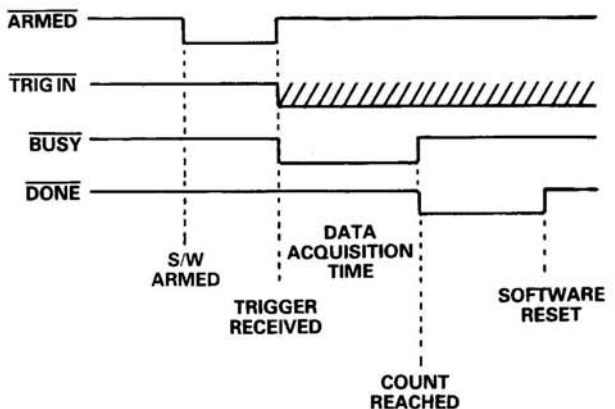

Figure 1. External TTL Triggering (Post Trigger Mode)

Analog triggering involves the comparison of an analog input signal against a software specified threshold voltage value (Trigger Level). Through software, the board can be configured to acquire data when the analog input voltage is above or below the threshold voltage. This method, called level triggering, is shown in the diagrams below.

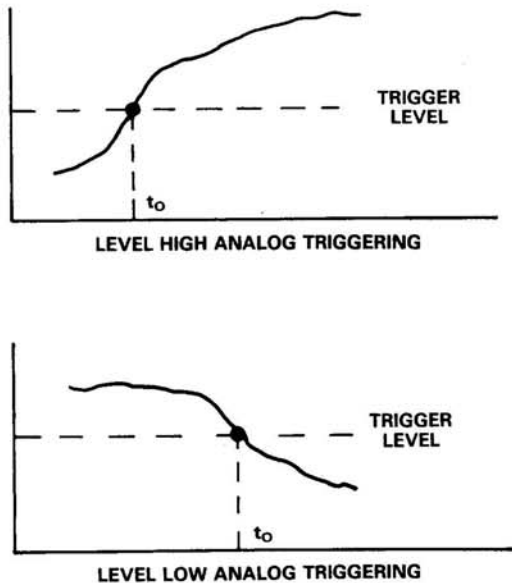

Figure 2. Analog Level Triggering

In addition to level triggering, the board has the capability to acquire data when the analog input voltage crosses the threshold voltage with a positive or negative slope. This method, called slope triggering, enhances the level triggering scheme by providing the capability to trigger off of an analog voltage value at the precise time the voltage crosses the threshold in either an upward or downward direction (see Figure 3).

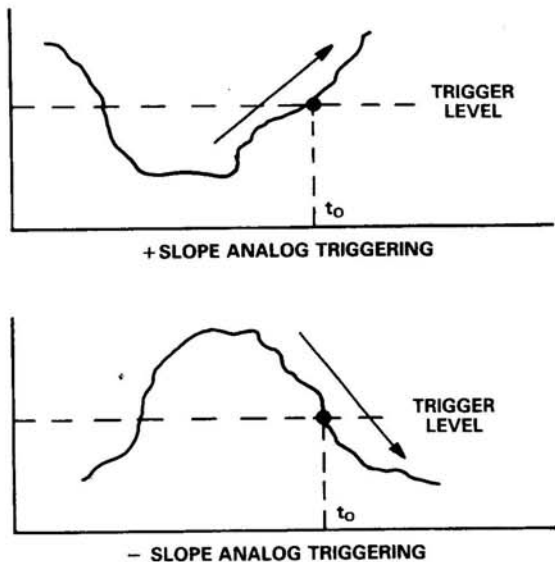

Figure 3. Analog Slope Triggering

Any of the eight analog input channels may be used as trigger input voltages. The threshold voltage is set with an on-board D/A converter with a resolution of 8 bits and an accuracy of $\pm 1\%$. In addition, an auxiliary analog input channel is provided to trigger off of an analog voltage not used as an input on the board. The auxiliary channel is a single-ended input with a voltage range of $\pm 10V$.

ON-BOARD MEMORY

The RTI-850's memory size is sufficient for 256K data samples. A memory controller is used to arbitrate memory access requests from the A/D converter and the system. The maximum throughput rate of 55kHz (14 bits) is achieved when storing data into on-board memory or into the AT's system memory via DMA transfer.

The on-board RAM allows up to 256K data samples to be stored locally. In fact, the on-board RAM is equivalent to the full storage capacity of a 512K byte system. Random data samples (or buffers of data) may be read from the card into the system memory, manipulated by the system processor, and once again stored into the local card memory.

In addition to its large data storage capability, the RTI-850's on-board memory provides two important functions. The board supports a pre-trigger mode of operation for users whose applications requires collection of data prior to receiving an external trigger. While in the pre-trigger mode, the RTI-850 continuously acquires, converts, and stores data samples into a user-specified circular buffer in the on-board RAM. The samples acquired prior to the trigger are stored as pre-trigger samples, and the remaining samples are stored as post-trigger samples.

A second feature of the on-board memory is the continuous transfer memory mode. While in continuous transfer, data is serially stored in two banks of the on-board RAM. A counter is used to count the number of samples in each bank; and when the bank is filled, its data is automatically transferred to system memory using the 80286's REP INSW command while the second memory bank is filled with new data. The process is repeated until all of the required samples of data have been taken.

SPECIFICATIONS (typical at 25°C with nominal power supply unless otherwise noted)

ANALOG INPUT Number of Input Channels Input Resolution ¹ Input Range Input Protection A/D Conversion Time Throughput Measurement Accuracy Common-Mode Voltage Range ² Common-Mode Rejection Input Impedance Input Bias Current Sample-and-Hold (SHA) Acquisition Time Integral Nonlinearity Differential Nonlinearity Input Offset Drift Gain Drift	8 Differential 16 Bits (65,536 Counts) ± 10V ± 35V (Powered), ± 20V (Unpowered) 15.5µs (16 Bits), 13.5µs (14 Bits) 50kHz typical, 45kHz minimum @ 16 Bits 0.003% of FSR ± 10V max 92dB dc to 60Hz, 1k Unbalanced > 10 ⁸ Ω 200pA 4µs to 0.003%, 20V Step 0.003% ± 1/2LSB @ 14 Bits 4 ppm/°C 12 ppm/°C
TRIGGER External TTL Trigger Input Analog Trigger Level Range Accuracy Hysteresis Software Trigger Resolution Auxiliary Analog Trigger Input Input Mode Input Impedance Input Protection Trigger Output	TTL Compatible ± 10V ± 1% ± 10mV 8 Bits (78mV/Step) Single-Ended > 10 ⁷ Ω ± 35V (Powered), ± 20V (Unpowered) TTL Compatible
PACER CLOCK Sampling Range Internal Pacer Clock Time Base External Pacer Clock Input	1µs to 131.07s 5.0MHz (200ns Resolution) TTL Compatible
MEMORY SPECIFICATIONS Size Transfer Speed (to System Memory)	256K × 16 Bits 1.45MB/s @ 6MHz 1.85MB/s @ 8MHz
SYSTEM CONFIGURATION Bus Resource Utilization Base Address Selection Interrupt Levels Interrupt Sources Compatibility	Occupies One Long Slot in the IBM PC AT Expansion Bus Switch Selectable I/O Location (16 Consecutive Words), 100H to 3E0H 3, 5, 7, 9, 10, 11, 12, 15 A/D Done, Terminal Count (DMA), Continuous Data Transfer, Board Error IBM PC AT @ 6MHz & 8MHz and 100% Compatibles
PHYSICAL/ENVIRONMENTAL Analog I/O Connector Operating Temperature Range Storage Temperature Range Relative Humidity	50-Position Pin and Socket 0 to +70°C -25°C to +85°C Up to 90% (Noncondensing)
POWER REQUIREMENTS Power Consumption	+5V @ 3A max (2.5A typical)

NOTES

¹The RTI-850 supports 15-bit and 14-bit short-cycle modes (jumper selectable).

²Includes signal voltage.

Specifications subject to change without notice.

ACCESSORIES



STB-GP Screw Termination Panel
 The STB-GP is a general purpose screw termination panel for the RTI-850 and RTI-860 that provides remote signal termination for all I/O signals. The panel is shipped with built-in standoffs

to allow for table top operation and may also be mounted in a rack mount kit (ADI#RMK02). A three-foot ribbon cable is also included.

The panel provides a user configurable input network for filters, attenuators, shunts, etc., as shown in Figure 4 below. The network is a series of holes and pads connected by etch in a pattern that allows the user to construct various circuit functions for both single-ended and differential inputs. A breadboard area of 8 square inches is provided for user installed circuit components. The area is a grid of holes on tenth-inch centers that are over-sized to allow the user to install wire-wrap sockets.

The STB-GP also provides three status LEDs for operation with the RTI-850 and RTI-860 boards. The LEDs indicate the state of the ARMED, BUSY, and DONE signals on the card. The status LEDs are powered from the IBM PC AT's power source and are useful in monitoring triggered acquisitions or paced conversions.

SOFTWARE SUPPORT

Two levels of software support are available for the RTI-850. The AC1527-B provides MS-DOS based high level language drivers that allow the RTI-850 to be programmed in languages such as BASIC, C, and PASCAL. The driver package includes configuration utilities, calibration routines, I/O commands for all the hardware functions of the board, and supporting documentation. A user-prompted test program, ADITEST.EXE, is also provided to allow users to test all I/O functions of the board.

The second level of software support for the RTI-850 is menu-driven application software for users not wanting to program the board. All application software is menu-driven and thus allows any application to be configured and executed quickly and easily.

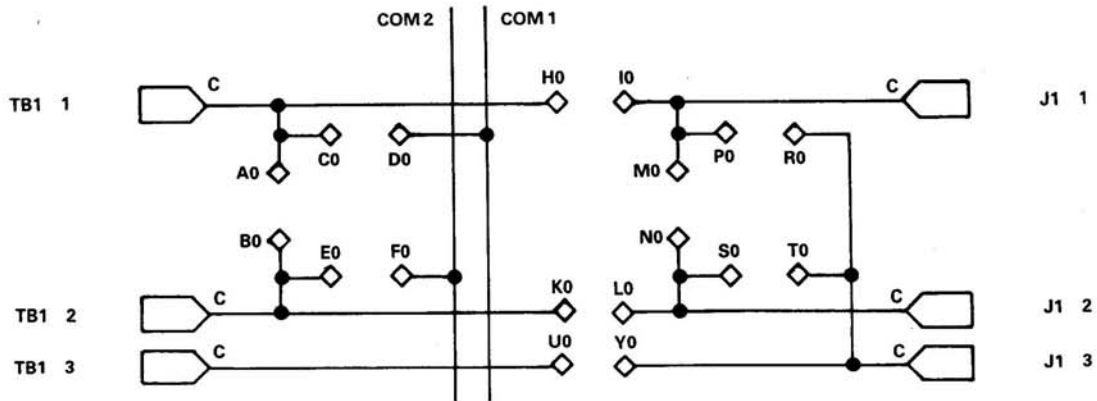

Figure 4. STB-GP Input Network