



# BUZ71A

## N - CHANNEL 50V - 0.1Ω - 13A TO-220 STripFET™ POWER MOSFET

TYPE	V <sub>DSS</sub>	R <sub>DS(on)</sub>	I <sub>D</sub>
BUZ71A	50 V	< 0.12 Ω	13 A

- TYPICAL R<sub>DS(on)</sub> = 0.1 Ω
- AVALANCHE RUGGED TECHNOLOGY
- 100% AVALANCHE TESTED
- HIGH CURRENT CAPABILITY
- 175°C OPERATING TEMPERATURE

### APPLICATIONS

- HIGH CURRENT, HIGH SPEED SWITCHING
- SOLENOID AND RELAY DRIVERS
- REGULATORS
- DC-DC & DC-AC CONVERTERS
- MOTOR CONTROL, AUDIO AMPLIFIERS
- AUTOMOTIVE ENVIRONMENT (INJECTION, ABS, AIR-BAG, LAMPDRIVERS, Etc.)

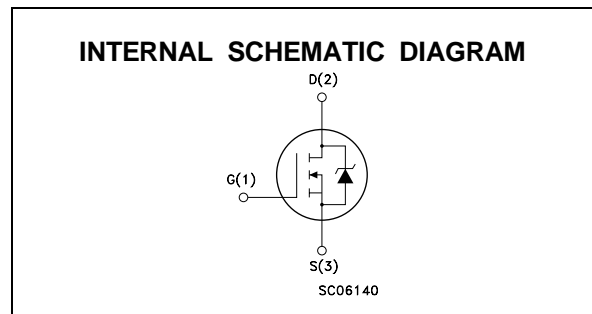
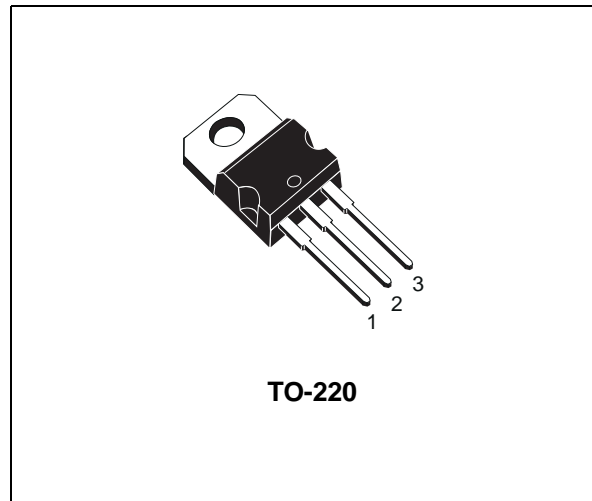

### ABSOLUTE MAXIMUM RATINGS

Symbol	Parameter	Value	Unit
V <sub>DS</sub>	Drain-source Voltage (V <sub>GS</sub> = 0)	50	V
V <sub>DGR</sub>	Drain- gate Voltage (R <sub>GS</sub> = 20 kΩ)	50	V
V <sub>GS</sub>	Gate-source Voltage	± 20	V
I <sub>D</sub>	Drain Current (continuous) at T <sub>c</sub> = 25 °C	13	A
I <sub>DM</sub>	Drain Current (pulsed)	52	A
P <sub>tot</sub>	Total Dissipation at T <sub>c</sub> = 25 °C	40	W
T <sub>stg</sub>	Storage Temperature	-65 to 175	°C
T <sub>j</sub>	Max. Operating Junction Temperature	175	°C
	DIN HUMIDITY CATEGORY (DIN 40040)	E	
	IEC CLIMATIC CATEGORY (DIN IEC 68-1)	55/150/56	

First digit of the datecode being Z or K identifies silicon characterized in this datasheet.

## BUZ71A

### THERMAL DATA

R <sub>thj-case</sub>	Thermal Resistance Junction-case	Max	3.75	°C/W
R <sub>thj-amb</sub>	Thermal Resistance Junction-ambient	Max	62.5	°C/W

### AVALANCHE CHARACTERISTICS

Symbol	Parameter	Value	Unit
I <sub>AR</sub>	Avalanche Current, Repetitive or Not-Repetitive (pulse width limited by T <sub>j</sub> max)	14	A
E <sub>AS</sub>	Single Pulse Avalanche Energy (starting T <sub>j</sub> = 25 °C, I <sub>D</sub> = I <sub>AR</sub> , V <sub>DD</sub> = 25 V)	50	mJ

### ELECTRICAL CHARACTERISTICS (T<sub>case</sub> = 25 °C unless otherwise specified)

OFF

Symbol	Parameter	Test Conditions	Min.	Typ.	Max.	Unit
V <sub>(BR)DSS</sub>	Drain-source Breakdown Voltage	I <sub>D</sub> = 250 μA V <sub>GS</sub> = 0	50			V
I <sub>DSS</sub>	Zero Gate Voltage Drain Current (V <sub>GS</sub> = 0)	V <sub>DS</sub> = Max Rating V <sub>DS</sub> = Max Rating T <sub>j</sub> = 125 °C			1 10	μA μA
I <sub>GSS</sub>	Gate-body Leakage Current (V <sub>DS</sub> = 0)	V <sub>GS</sub> = ± 20 V			± 100	nA

ON (\*)

Symbol	Parameter	Test Conditions	Min.	Typ.	Max.	Unit
V <sub>GS(th)</sub>	Gate Threshold Voltage	V <sub>DS</sub> = V <sub>GS</sub> I <sub>D</sub> = 1 mA	2.1	3	4	V
R <sub>DS(on)</sub>	Static Drain-source On Resistance	V <sub>GS</sub> = 10 V I <sub>D</sub> = 9 A		0.1	0.12	Ω

### DYNAMIC

Symbol	Parameter	Test Conditions	Min.	Typ.	Max.	Unit
g <sub>fs</sub> (*)	Forward Transconductance	V <sub>DS</sub> = 25 V I <sub>D</sub> = 9 A	4	7.7		S
C <sub>iSS</sub>	Input Capacitance	V <sub>DS</sub> = 25 V f = 1 MHz V <sub>GS</sub> = 0		760		pF
C <sub>oSS</sub>	Output Capacitance			100		pF
C <sub>rSS</sub>	Reverse Transfer Capacitance			30		pF

### SWITCHING

Symbol	Parameter	Test Conditions	Min.	Typ.	Max.	Unit
t <sub>d(on)</sub>	Turn-on Time	V <sub>DD</sub> = 30 V I <sub>D</sub> = 8 A R <sub>GS</sub> = 50 Ω V <sub>GS</sub> = 10 V		20		ns
t <sub>r</sub>	Rise Time			65		ns
t <sub>d(off)</sub>	Turn-off Delay Time			70		ns
t <sub>f</sub>	Fall Time			35		ns

**ELECTRICAL CHARACTERISTICS** (continued)  
**SOURCE DRAIN DIODE**

Symbol	Parameter	Test Conditions	Min.	Typ.	Max.	Unit
$I_{SD}$	Source-drain Current				13	A
$I_{SDM}$	Source-drain Current (pulsed)				52	A
$V_{SD} (*)$	Forward On Voltage	$I_{SD} = 28 \text{ A}$ $V_{GS} = 0$			1.8	V
$t_{rr}$	Reverse Recovery Time	$I_{SD} = 14 \text{ A}$ $di/dt = 100 \text{ A}/\mu\text{s}$ $V_{DD} = 30 \text{ V}$ $T_j = 150 \text{ }^\circ\text{C}$		65		ns
$Q_{rr}$	Reverse Recovery Charge			0.17		$\mu\text{C}$

(\*) Pulsed: Pulse duration = 300  $\mu\text{s}$ , duty cycle 1.5 %

Safe Operating Area

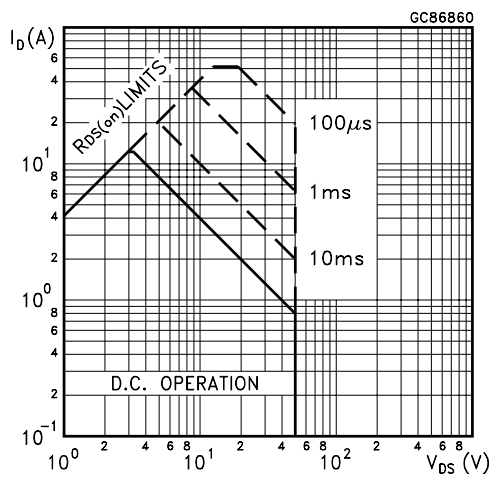

Thermal Impedance

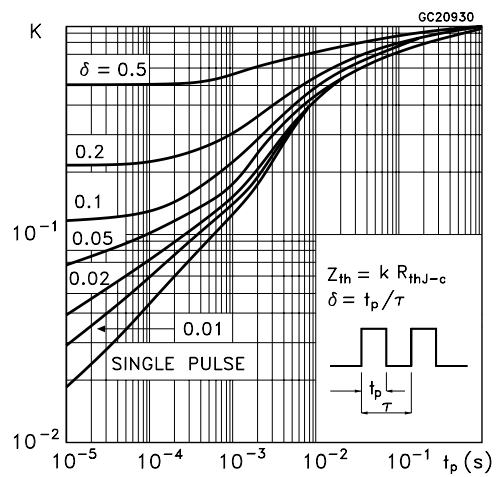

Output Characteristics

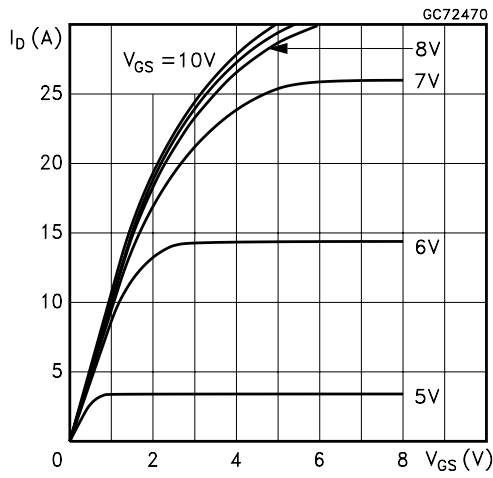

Transfer Characteristics

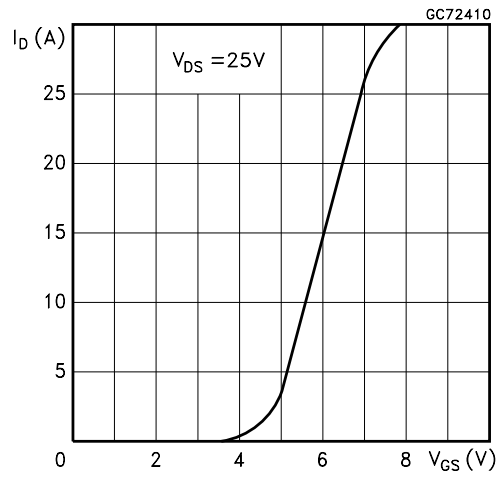

Transconductance

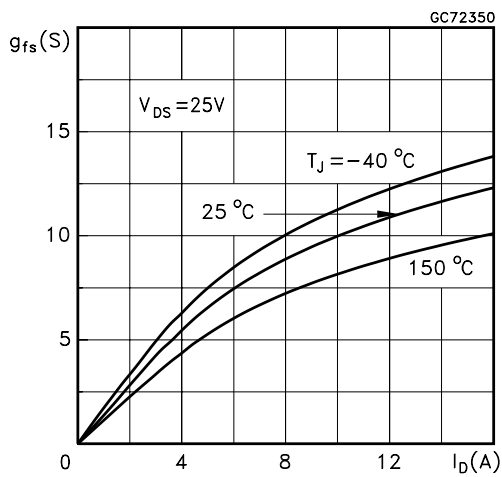

Static Drain-source On Resistance

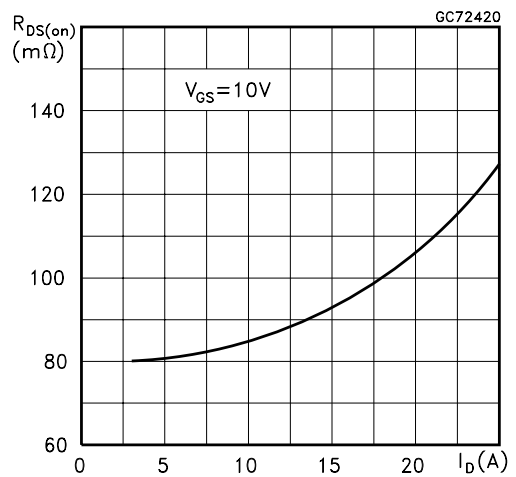

Gate Charge vs Gate-source Voltage

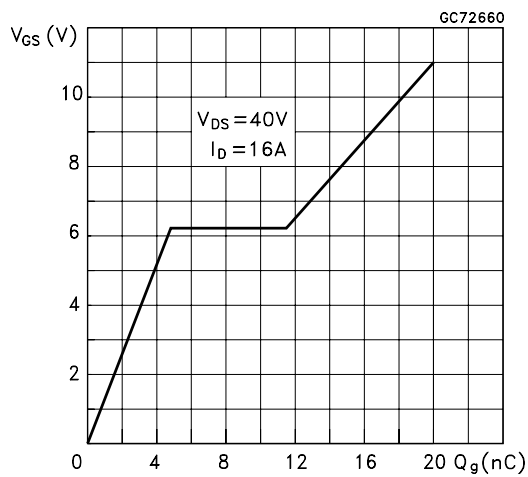

Capacitance Variations

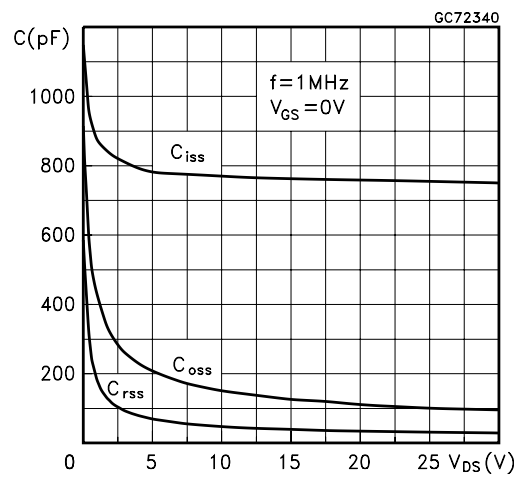

Normalized Gate Threshold Voltage vs Temperature

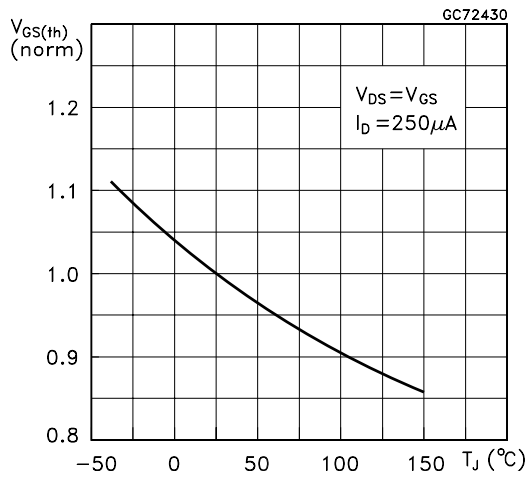

Normalized On Resistance vs Temperature

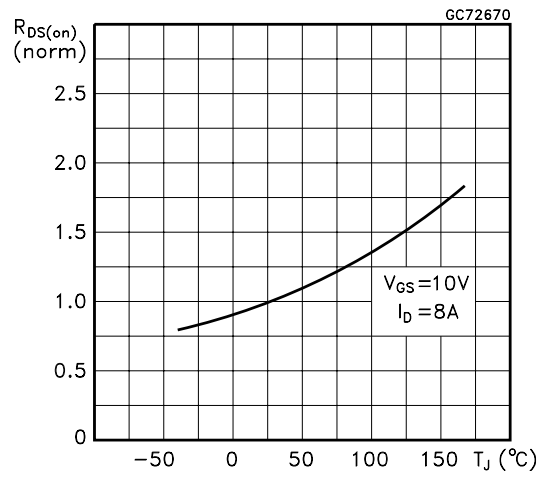

Source-drain Diode Forward Characteristics

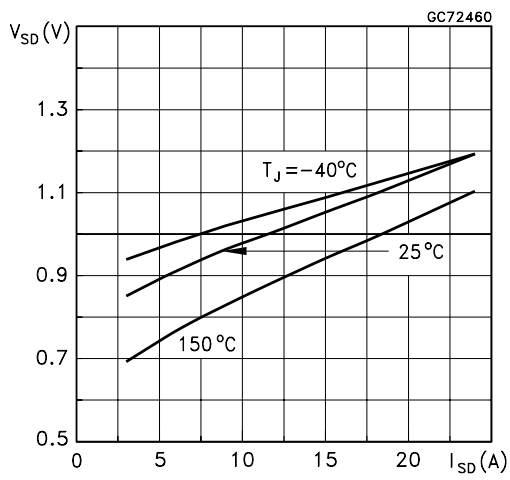

**Fig. 1: Unclamped Inductive Load Test Circuit**



**Fig. 2: Unclamped Inductive Waveform**

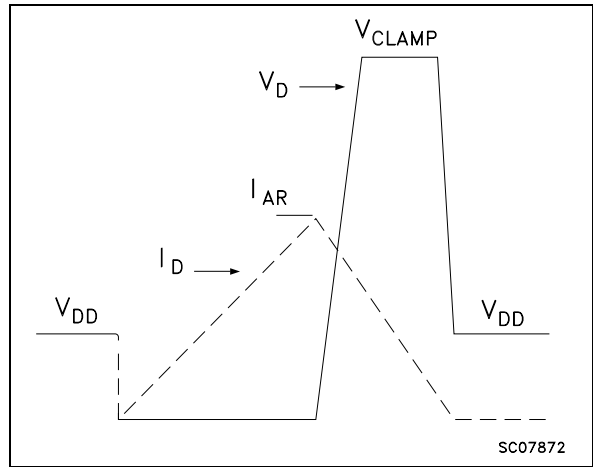

**Fig. 3: Switching Times Test Circuits For Resistive Load**



**Fig. 4: Gate Charge test Circuit**

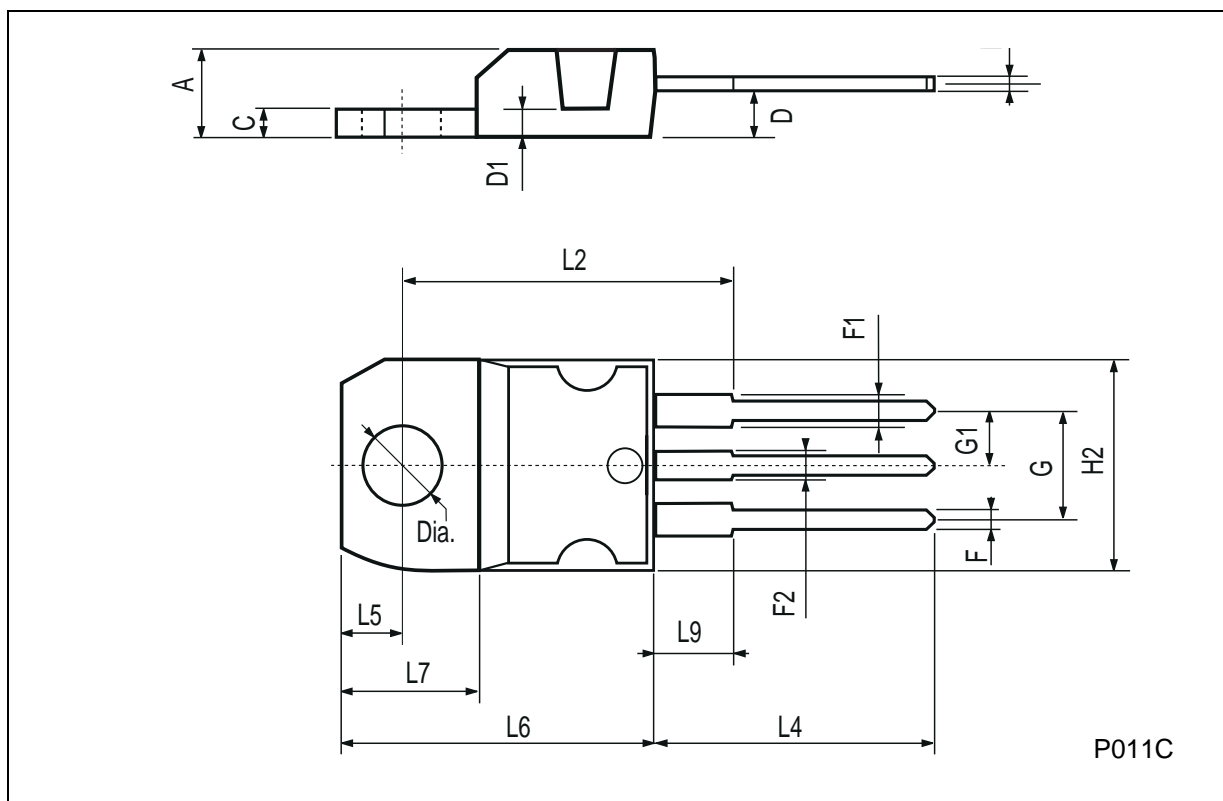

**Fig. 5: Test Circuit For Inductive Load Switching And Diode Recovery Times**



## TO-220 MECHANICAL DATA

DIM.	mm			inch		
	MIN.	TYP.	MAX.	MIN.	TYP.	MAX.
A	4.40		4.60	0.173		0.181
C	1.23		1.32	0.048		0.051
D	2.40		2.72	0.094		0.107
D1		1.27			0.050	
E	0.49		0.70	0.019		0.027
F	0.61		0.88	0.024		0.034
F1	1.14		1.70	0.044		0.067
F2	1.14		1.70	0.044		0.067
G	4.95		5.15	0.194		0.203
G1	2.4		2.7	0.094		0.106
H2	10.0		10.40	0.393		0.409
L2		16.4			0.645	
L4	13.0		14.0	0.511		0.551
L5	2.65		2.95	0.104		0.116
L6	15.25		15.75	0.600		0.620
L7	6.2		6.6	0.244		0.260
L9	3.5		3.93	0.137		0.154
DIA.	3.75		3.85	0.147		0.151



Information furnished is believed to be accurate and reliable. However, STMicroelectronics assumes no responsibility for the consequences of use of such information nor for any infringement of patents or other rights of third parties which may result from its use. No license is granted by implication or otherwise under any patent or patent rights of STMicroelectronics. Specification mentioned in this publication are subject to change without notice. This publication supersedes and replaces all information previously supplied. STMicroelectronics products are not authorized for use as critical components in life support devices or systems without express written approval of STMicroelectronics.

The ST logo is a trademark of STMicroelectronics

© 1999 STMicroelectronics – Printed in Italy – All Rights Reserved  
STMicroelectronics GROUP OF COMPANIES

Australia - Brazil - China - Finland - France - Germany - Hong Kong - India - Italy - Japan - Malaysia - Malta - Morocco -  
Singapore - Spain - Sweden - Switzerland - United Kingdom - U.S.A.

<http://www.st.com>