

# Ultra-Fast-Recovery Rectifier Diodes 800V

$t_{rr} \textcircled{1}$ :  $I_F/I_R (=I_F)$  90% Recovery Point  
 (ex.  $I_F/I_R = 100\text{mA}/100\text{mA}$  90% Recovery Point)  
 $t_{rr} \textcircled{2}$ :  $I_F/I_R (=2 I_F)$  75% Recovery Point  
 (ex.  $I_F/I_R = 100\text{mA}/200\text{mA}$  75% Recovery Point)

$V_{RM}$ (V)	Package	Part Number	$I_F$ (AV) (A)	$I_{FSM}$ (A)	$T_j$ (°C)	$T_{stg}$ (°C)	$V_F$ (V) max	$I_F$ (A)	$I_R$ ( $\mu$ A)	$I_R$ (H) (mA)	$T_a$ (°C)	$t_{rr} \textcircled{1}$ (ns)		$t_{rr} \textcircled{2}$ (ns)		$R_{th(j-c)}$ (°C/W)	Mass (g)	Fig. No.	Page where characteristic curve is shown
				50Hz Half-cycle Sinewave Single Shot					$V_R = V_{RM}$ max	$V_R = V_{RM}$ max		$I_F/I_{FP}$ (mA)	$I_F/I_{FP}$ (mA)						
800	Frame-2Pin	FMC-G28S	3.0	50	-40 to +150	3.0	3.0	100	1	150 (Tj)	70	500/500	35	500/1000	4.0	2.1	1	71	
		FMC-G28SL	5.0	60	-40 to +150	3.0	5.0	200	2	150 (Tj)	70	500/500	35	500/1000	4.0	2.1			
	Center-tap	FMC-28U	3.0	50	-40 to +150	3.0	3.0	100	0.5	150 (Tj)	70	500/500	35	500/1000	4.0	2.1	2	74	

## External Dimensions

Flammability: UL94V-0 or Equivalent (Unit: mm)

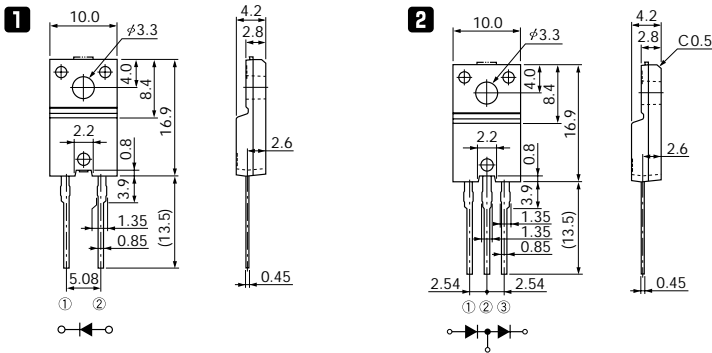

# Ultra-Fast-Recovery Rectifier Diodes

## FMG-G36S

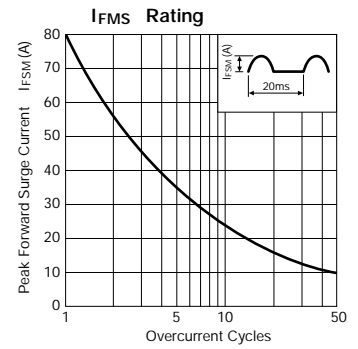
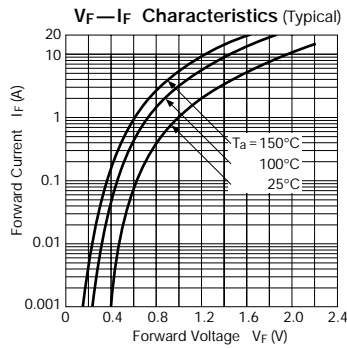
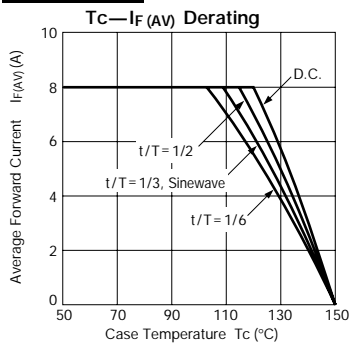

## FMG-G3CS

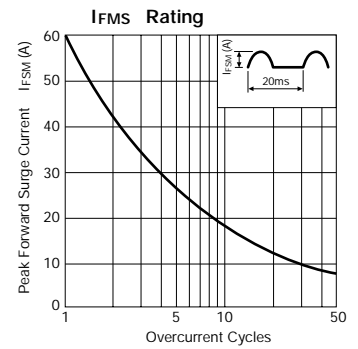
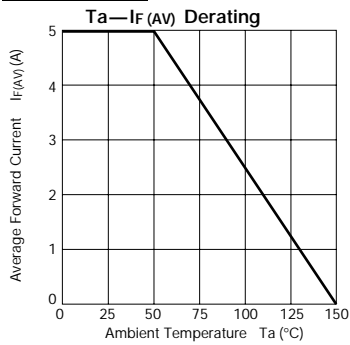

## FMC-26U, 26UA

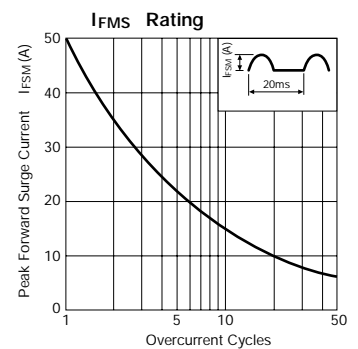
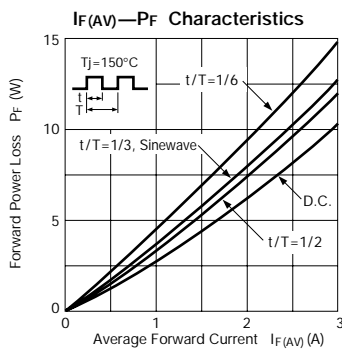
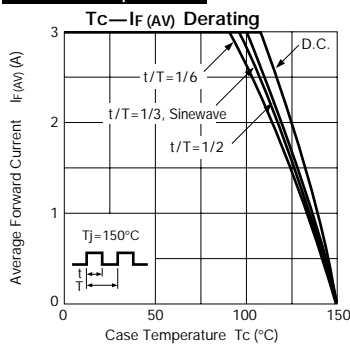

## FMC-28U, 28UA

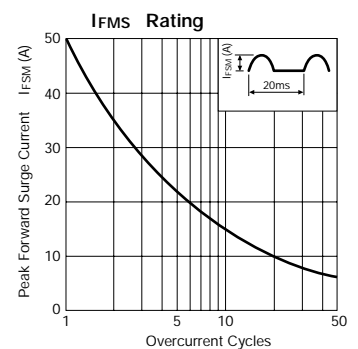
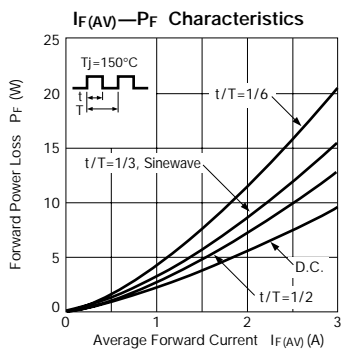
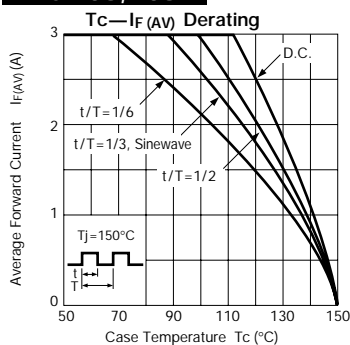

## FMG-12S/R, 13S/R

