

GaAs IC 5 Bit Digital Attenuator with Driver 1 dB LSB Positive Control DC–2 GHz



AA110-85

Features

- Attenuation 1 dB Steps to 31 dB With High Accuracy
- Single Positive Control (+3 V or +5 V) for Each Bit
- Low DC Power Consumption
- CMOS Integrated Silicon Driver
- Designed for Use at IF Frequencies at Input Power Levels > -10 dBm

Description

The AA110-85 is a 5 bit, single positive control GaAs IC FET digital attenuator with driver. It is particularly suited at IF frequencies where high attenuation accuracy, low insertion loss and low intermodulation products are required. Typical applications include base station, wireless data, broadband and wireless local loop gain control circuits. For low power applications (< -10 dBm) see part number AA117-85.

SSOP-20

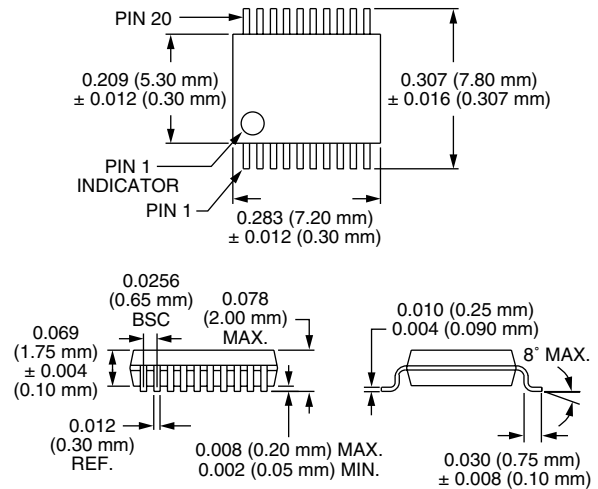

Electrical Specifications at -40°C to +85°C (V_{CC} = +5 V)

Parameter ¹	Condition	Frequency	Min.	Typ.	Max.	Unit
Insertion Loss ²		DC–0.5 GHz		1.4	1.7	dB
		DC–1.0 GHz		1.7	2.1	dB
		DC–2.0 GHz		2.2	2.6	dB
Attenuation Range				31		dB
Attenuation Accuracy ³		DC–0.5 GHz	± (0.2 + 2% of Attenuation Setting in dB)			dB
		DC–1.0 GHz	± (0.25 + 3% of Attenuation Setting in dB)			dB
		DC–2.0 GHz	± (0.4 + 6% of Attenuation Setting in dB)			dB
VSWR (I/O) ⁴		DC–2.0 GHz		1.5:1	1.8:1	
Switching Characteristics ⁵	Rise, Fall (10/90% or 90/10% RF) On, Off (50% CTL to 90/10% RF) Video Feedthru			15		ns
				50		ns
				50		mV
Input Power for 1 dB Compression	V _{CC} = +5 V	0.5–2.0 GHz 0.05 GHz	+22 +16	+27 +20		dBm dBm
Intermodulation Intercept Point (IP3)	For Two-tone Input Power +5 dBm V _{CC} = +5 V	0.5–2.0 GHz 0.05 GHz	+40 +28	+46 +34		dBm dBm
Supply Voltage	V _{CC} = 5 V @ 750 μA Typ., 1 mA Max.					
Control Voltages	CTL1, CTL2, CTL4, CTL8, CTL16, Low = 0 to 0.8 V @ 20 μA Typ. CTL1, CTL2, CTL4, CTL8, CTL16, High = 3.0 to 5.0 V @ 20 μA Typ.					

1. All measurements made in a 50 Ω system, unless otherwise specified.
2. Insertion loss changes by 0.003 dB/°C.
3. Attenuation referenced to insertion loss.

4. Input/output.
5. Video feedthru measured with 1 ns risetime pulse and 500 MHz bandwidth.

Typical Performance Data ($V_{CC} = +5\text{ V}$)

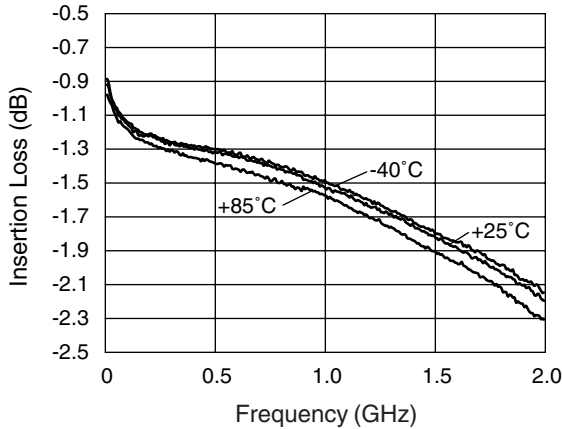

Insertion Loss vs. Frequency

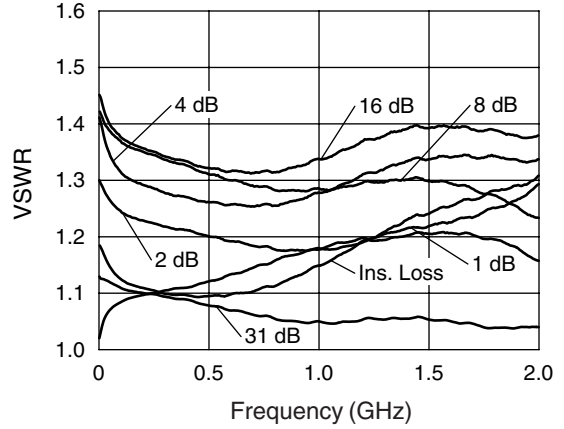

VSWR vs. Frequency (25°C)

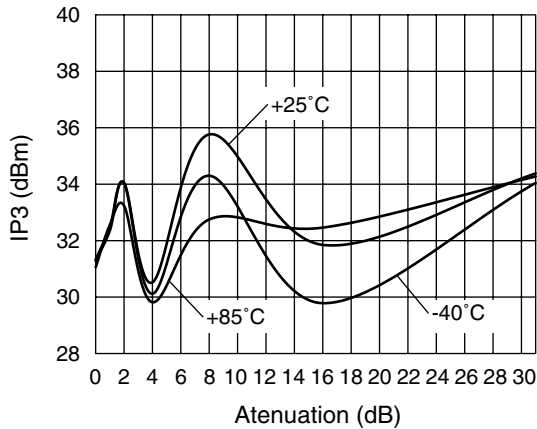

IP3 vs. Attenuation and Temperature, Main Bits (50 MHz) $V_{CC} = +5\text{ V}$

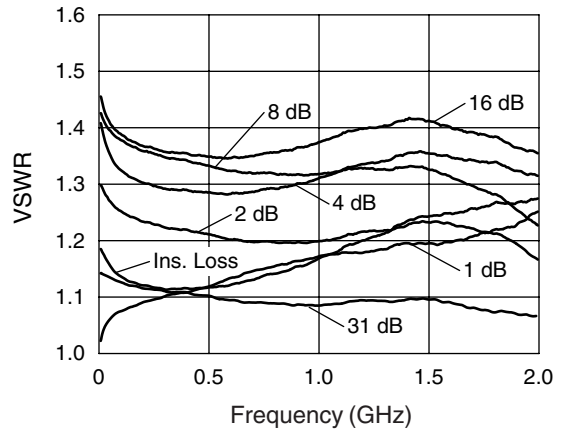

VSWR vs. Frequency (85°C)

Compression Point vs. Attenuation, Voltage, and Temperature

Attenuation State	Control Voltage (V)	Input Power @ 1 dB Compression		
		+25°C (dBm)	+85°C (dBm)	-40°C (dBm)
Ins. Loss	5	17.2	17.3	19.9
1 dB	5	18.1	18.2	17.8
2 dB	5	19.3	19.5	19.2
4 dB	5	16.9	16.9	16.8
8 dB	5	21.3	21.6	22.4
16 dB	5	18.6	17.8	18.5
31 dB	5	21.4	21.1	21.3

Frequency = 50 MHz.

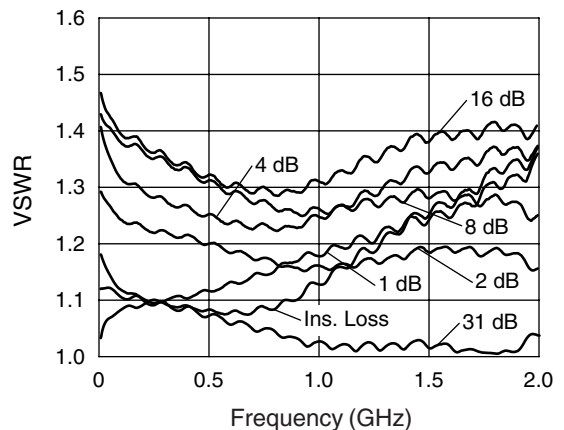

VSWR vs. Frequency (-40°C)

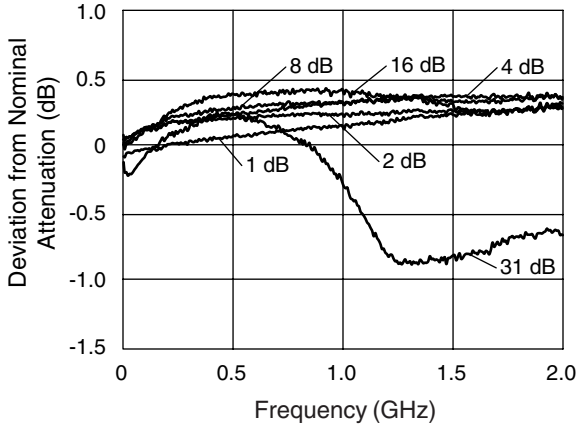

Attenuation Accuracy vs. Frequency (25°C)

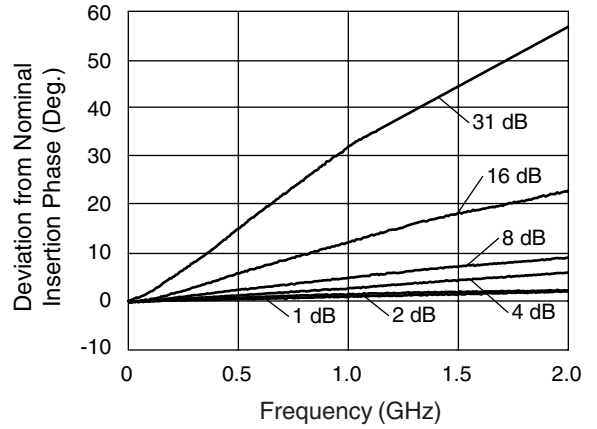

Attenuation Phase Accuracy vs. Frequency (25°C)

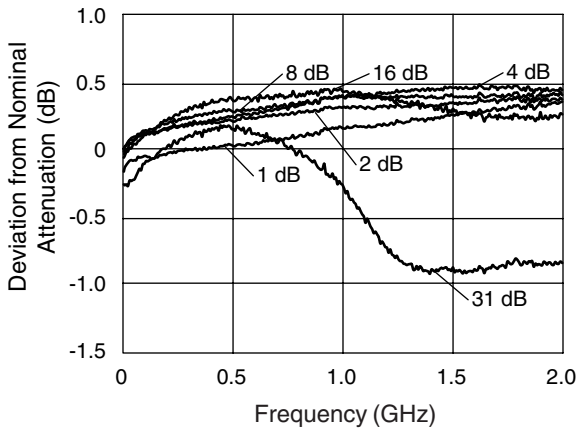

Attenuation Accuracy vs. Frequency (85°C)

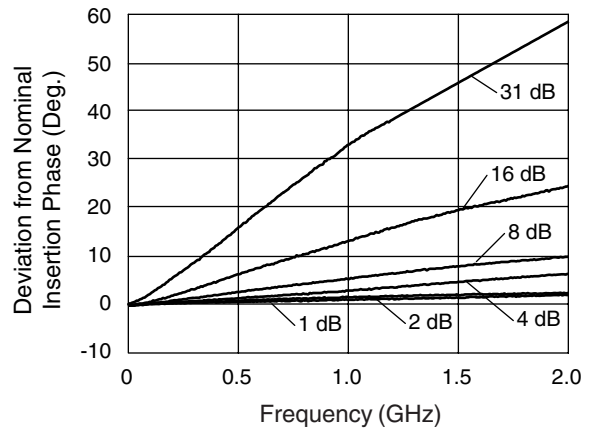

Attenuation Phase Accuracy vs. Frequency (85°C)

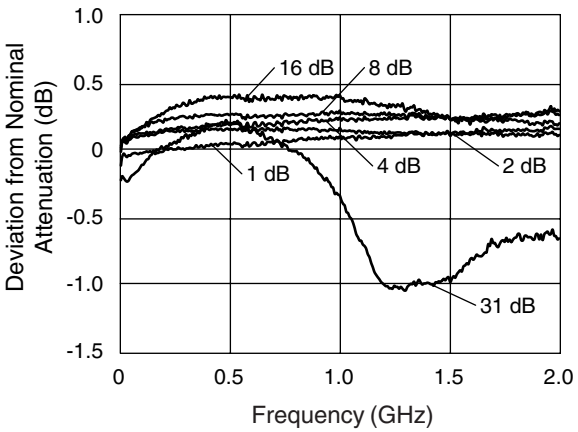

Attenuation Accuracy vs. Frequency (-40°C)

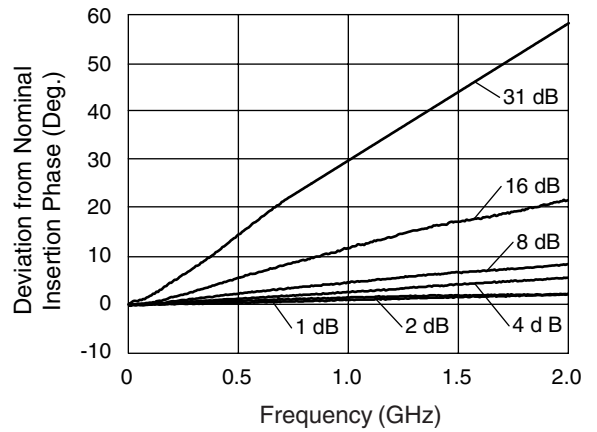

Attenuation Phase Accuracy vs. Frequency (-40°C)

Typical Performance Data ($V_{CC} = +3\text{ V}$)

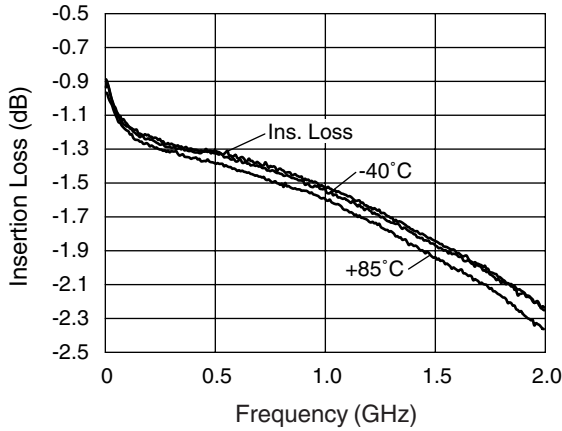

Insertion Loss vs. Frequency

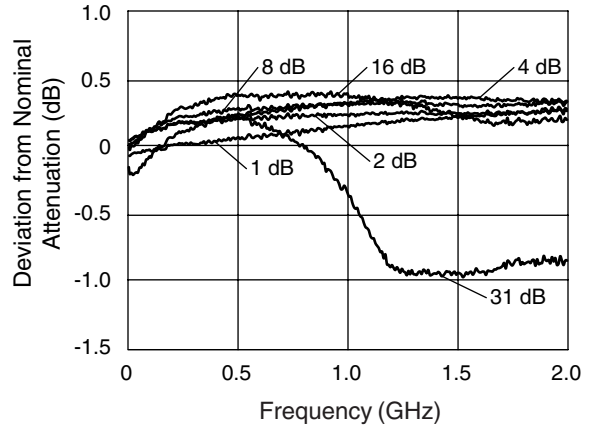

Attenuation Accuracy vs. Frequency (25°C)

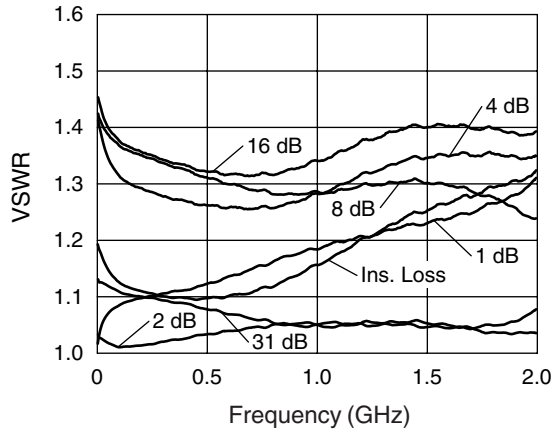

VSWR vs. Frequency (25°C)

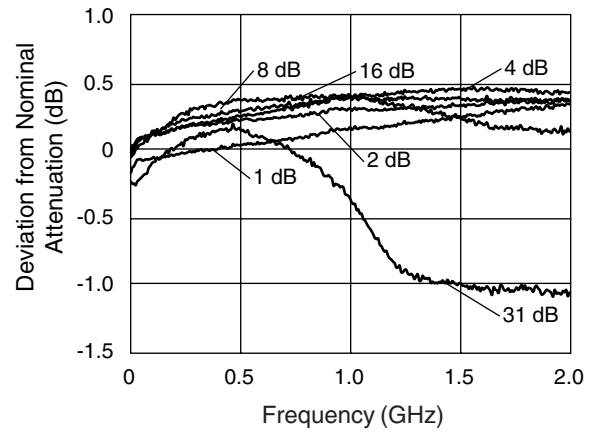

Attenuation Accuracy vs. Frequency (85°C)

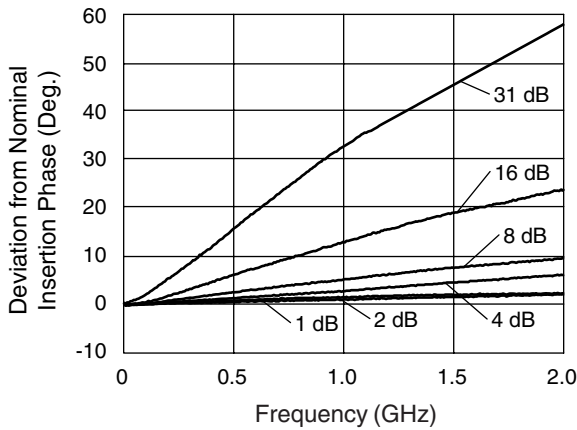

Attenuation Phase Accuracy vs. Frequency (25°C)

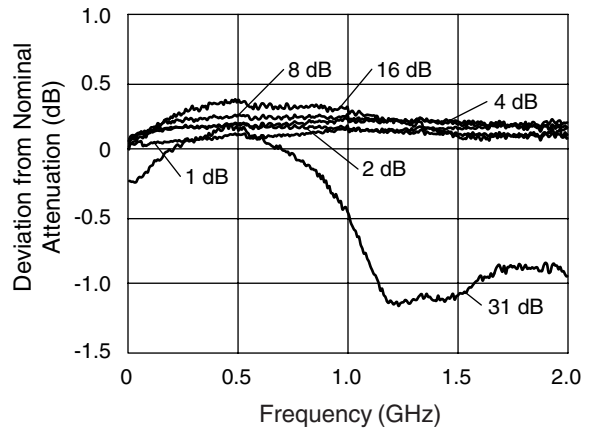

Attenuation Accuracy vs. Frequency (-40°C)

Compression Point vs. Attenuation, Voltage, and Temperature

Attenuation State	Control Voltage (V)	Input Power @ 1 dB Compression		
		+25°C (dBm)	+85°C (dBm)	-40°C (dBm)
Ins. Loss	3	16.6	16.6	16.5
1 dB	3	17.5	17.5	17.5
2 dB	3	18.9	19	18.8
4 dB	3	16.3	16.6	16.3
8 dB	3	20.6	21.1	21.8
16 dB	3	15.5	15.1	16.2
31 dB	3	20.2	19.9	20.1

Frequency = 50 MHz.

Absolute Maximum Ratings

Characteristic	Value
RF Input Power	2 W > 500 MHz, 0/6 V 0.5 W > 50 MHz, 0/6 V
Supply Voltage	6 V
Control Voltage ¹	-0.2 V, +6 V
Operating Temperature	-40°C to +85°C
Storage Temperature	-65°C to +150°C
θ_{JC}	85°C/W

Note: Exceeding these ratings may cause irreversible damage.

1. Control voltage must not exceed supply voltage.

Truth Table

CTL1	CTL2	CTL4	CTL8	CTL16	Attenuation J ₁ -J ₂
0	0	0	0	0	Ins. Loss
1	0	0	0	0	1 dB
0	1	0	0	0	2 dB
0	0	1	0	0	4 dB
0	0	0	1	0	8 dB
0	0	0	0	1	16 dB
1	1	1	1	1	31 dB

"0" = 0 to 0.8 V ($V_{CC} = 5$ V).

"1" = 3 to 5 V ($V_{CC} = 5$ V).

Pin Out

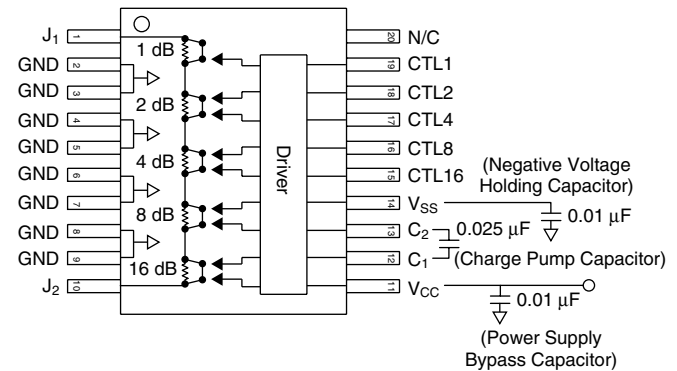

Application Information

The on chip charge pump oscillates at approximately 600 KHz, which may create noise in the user's circuit. When the input level to the attenuator is low, < -10 dBm, the signal to noise ratio starts to degrade. For many applications, input power levels are typically in the -20 dBm to -30 dBm range. At these input levels there is insufficient signal to noise. Skyworks has developed a solution to this problem. Part number AA117-85 has the same attenuation range as the AA110-85, but the charge pump oscillator has been turned off. The user can still control the part with 0/+V, however a negative V_{SS} voltage is required. See AA117-85 data sheet for further information.