

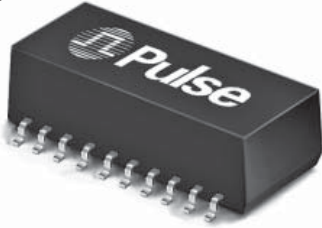





# ISDN S-INTERFACE MODULES

## Surface Mount, Dual, 1500 Vrms



-  RoHS peak reflow temperature rating 245°C
-  Meets the pulse waveform template of CCITT I.430 when recommended transformer and chip pair are used
-  Developed for enhanced EMC performance
-  Excellent longitudinal balance
-  Low- or high-frequency choke options available

### Electrical Specifications @ 25°C — Operating Temperature 0°C to 70°C

RoHS Compliant Part Number	Ratio (± 2%)	OCL Pri (mH MIN)	Ll Sec (μH MAX)	Cw/w (pF MAX)	CD Pri (pF MAX)	DCR Pri (Ω +25% MAX)	DCR Sec (Ω +25% MAX)	D lbc (mA MAX)	Isolation Voltage (Vrms MIN)	Δ lbc (mA MAX)	Secondary Pins
T5037NL	1CT:2.5CT	30	10	150	100	3.4	7.0	4.7 mH	1.4	3	20-18, 13-11
T5038NL	1CT:2CT	30	10	150	100	3.4	5.4	470 μH	1.4	3	20-18, 13-11
T5039NL	1CT:2.5CT	30	10	150	100	3.4	7.0	470 μH	1.4	3	20-18, 13-11
T5049NL	1CT:1CT	30	10	150	100	3.4	3.4	4.7 mH	1.4	3	20-18, 13-11
T5025 <sup>1</sup>	1:1	22	15	45	100	1.3	3.4	4.7 mH	1.4	3	20-18, 13-11

1. Non-RoHS part.

NOTE: When ordering Tape & Reel packaging, add a "T" suffix to the part number (ex: T5038NLT).

## Mechanical

### CEZ

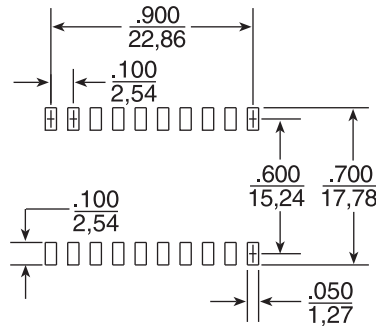
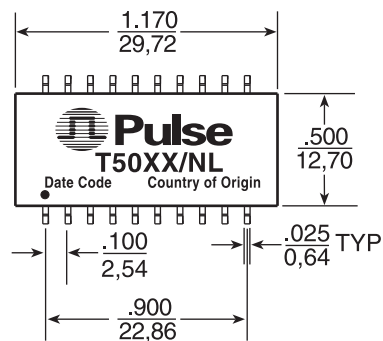

### SUGGESTED PAD LAYOUT

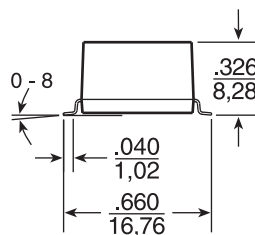
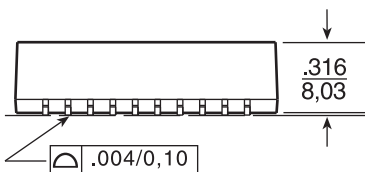

## Schematic

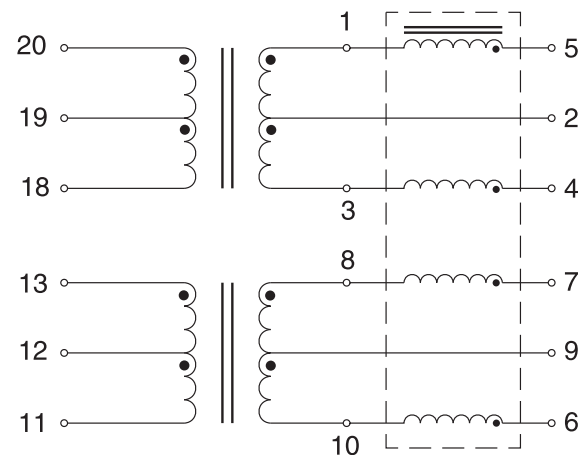

Weight ..... 6.94 grams  
 Tape & Reel ..... .250/reel  
 Tube ..... 15/tube

Dimensions:  $\frac{\text{Inches}}{\text{mm}}$

Unless otherwise specified, all tolerances are  $\pm \frac{.010}{0,25}$

# ISDN S-INTERFACE MODULES

## Surface Mount, Dual, 1500 Vrms



### Module Selection Guide

IC Manufacturer	IC Part Number	Pulse Part Number
<b>AMD</b>	AM79C 30A/32A	T5038NL
<b>Lucent (AT&amp;T)</b>	T7234/T7254/T7250/T7256/T7259 T7903	T5037/ T5039NL T5038NL
<b>Mietec</b>	MTC-2072	T5038NL
<b>Mitel</b>	MT8930/8931	T5038NL
<b>Motorola</b>	MC145574	T5037NL/T5039NL
<b>National</b>	TP3420/3421	T5038NL
<b>SGS Thomson</b>	ST5420/5421	T5038NL
<b>Siemens</b>	PEB2080/2081/2084/2085/2086 PSB 2186 PSB 21381/21382/21383/21384	T5038NL T5049NL
<b>Yamaha</b>	YM7405B	T5038NL

## Definition of Terms

**Ratio:** This is the turns ratio, expressed as "Primary:Secondary". The term "CT" designates a center-tapped winding.

**OCL:** Open Circuit Inductance, measured 20 kHz, 100 mV.

**L<sub>L</sub> Sec:** Leakage Inductance measured across the primary with the respective secondary winding short-circuited.

**C<sub>w/w</sub>:** Winding capacitance, formed by the primary and secondary wire. These wires form the "Plates" of this capacitor. Measured at 100 kHz, 20 mV.

**CD Pri:** This is the distributed capacitance.

**DCR:** This is the resistance of the windings when measured in DC conditions.

**Δ I<sub>DC</sub>:** The maximum specified unbalanced DC current capability of the device.

The minimum primary inductance and the maximum distributed capacitance satisfy the transmitter output and receiver input impedance requirements of CCITT I.430 for both TE and NT.

The maximum distributed capacitance allows sufficient margin for the capacitance of the IC and a protection diode network. It is consistent with the overall maximum value specified and permitted length of the basic access TE cord.

Flammability – Materials used in the products are recognized UL94-VO. Products meet the requirements of IEC 695-2-2 (needle flame test).

# ISDN S-INTERFACE MODULES

## Surface Mount, Dual, 1500 Vrms



### Application Notes

The S-Interface is the standardized four wire digital telephone access point defined by the CCITT I-Series recommendations for the Integrated Service Digital Network. This "basic rate access" accommodates two 64 Kbps "B-channels" for information, one 16 Kbps "D-channel" intended

for signaling and control, and 48 Kbps for framing and other purposes, giving a total rate of 192 Kbps. The CCITT physical layer recommends that the user network interface be transformer coupled as shown in our typical application notes.

### Typical S-Interface Application Circuit for Motorola MC145574

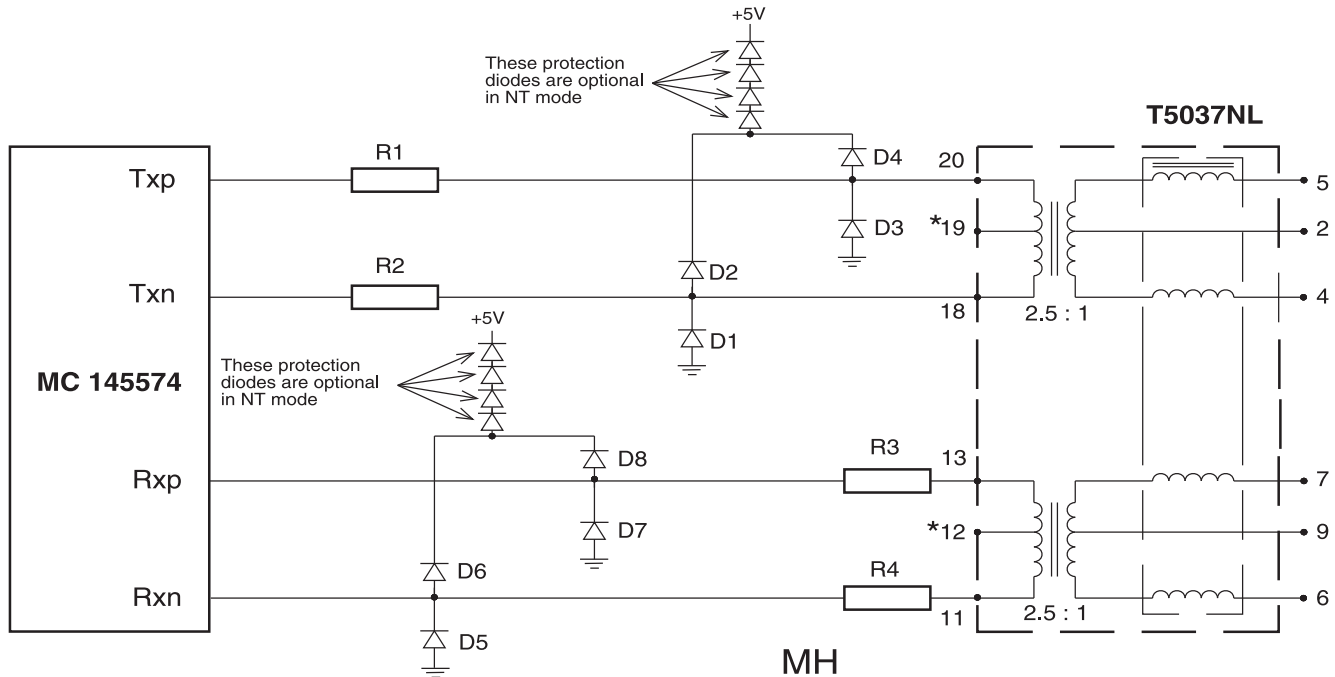

**\*NOTE:** Refer to Silicon Vendors' Application Notes for more details on power supply connection and specific component values.

### Common Mode Choke Performance

Typical Common Mode Attenuation for the high-frequency Common Mode Choke (470  $\mu$ H) based on a 50  $\Omega$  system.

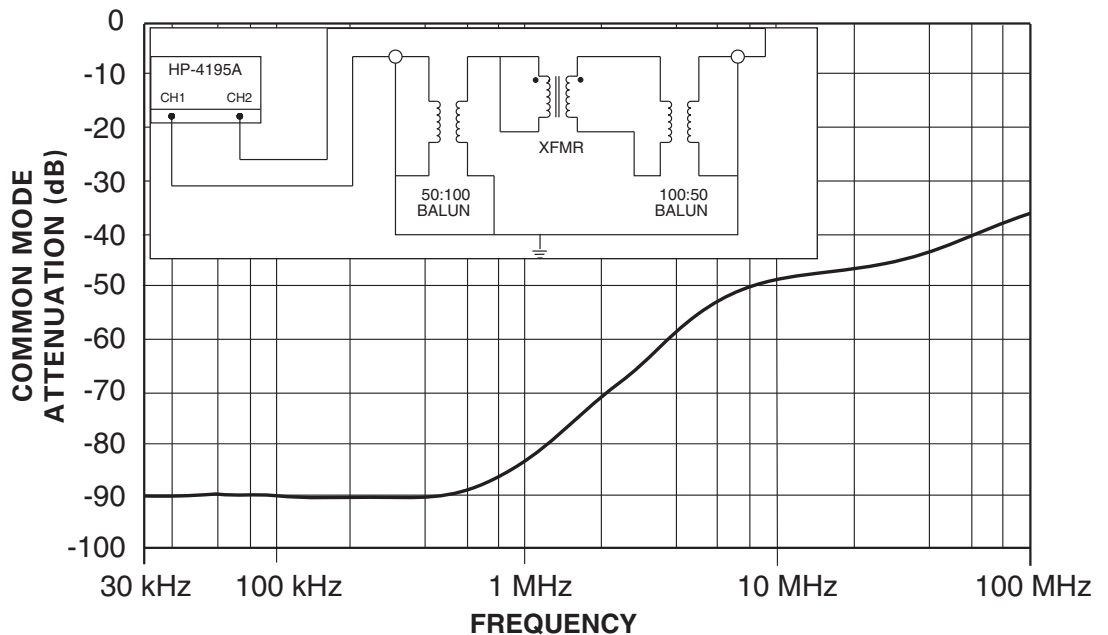

# ISDN S-INTERFACE MODULES

## Surface Mount, Dual, 1500 Vrms



### Common Mode Choke Performance (continued)

Typical Common Mode Attenuation for the low-frequency Common Mode Choke (4.7 mH) based on a 50  $\Omega$  system.

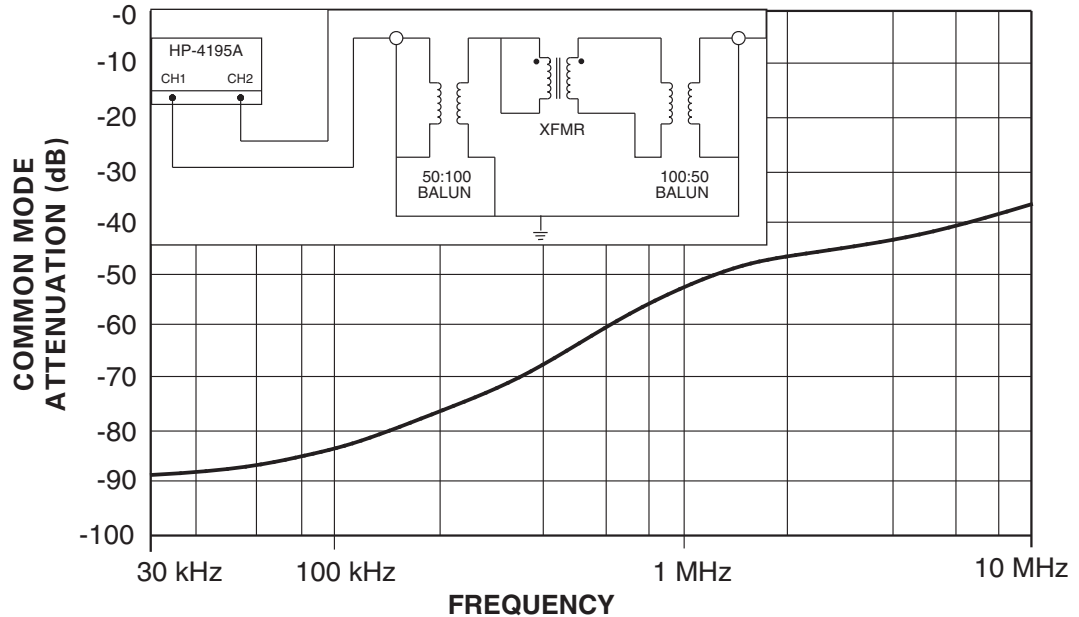

### For More Information:

Pulse Worldwide Headquarters	Pulse Europe	Pulse China Headquarters	Pulse North China	Pulse South Asia	Pulse North Asia
12220 World Trade Dr. San Diego, CA 92128 U.S.A.	Einsteinstrasse 1 D-71083 Herrenberg Germany	B402, Shenzhen Academy of Aerospace Technology Bldg. 10th Kejinan Rd. High-Tech Zone Nanshan District Shenzhen, PR China 518057	Room 1503 XinYin Building No. 888 YiShan Rd. Shanghai 200233 China	135 Joo Seng Rd. #03-02 PM Industrial Bldg. Singapore 368363	No. 26, Kao Ching Rd. Yang Mei Chen Taoyuan Hsien Taiwan R. O. C.
<a href="http://www.pulseeng.com">www.pulseeng.com</a> Tel: 858 674 8100 Fax: 858 674 8262	Tel: 49 7032 7806 0 Fax: 49 7032 7806 135	TEL: 86 755 33966678 FAX: 86 755 33966700	Tel: 86 21 54643211/2 Fax: 86 21 54643210	TEL: 65 6287 8998 FAX: 65 6280 0080	Tel: 886 3 4643715 Fax: 886 3 4641911

Performance warranty of products offered on this data sheet is limited to the parameters specified. Data is subject to change without notice. Other brand and product names mentioned herein may be trademarks or registered trademarks of their respective owners.  
© Copyright, 2009. Pulse Engineering, Inc. All rights reserved.