



RF Power Field Effect Transistors

N-Channel Enhancement-Mode Lateral MOSFETs

Designed for GSM and GSM EDGE base station applications with frequencies from 920 to 960 MHz. Suitable for CDMA and multicarrier amplifier applications.

- Typical GSM Performance: $V_{DD} = 28$ Volts, $I_{DQ} = 300$ mA, $P_{out} = 35.5$ Watts CW, $f = 960$ MHz
Power Gain — 19 dB
Drain Efficiency — 57%
- Capable of Handling 5:1 VSWR, @ 32 Vdc, 940 MHz, 70 Watts CW Output Power (3 dB Input Overdrive from Rated P_{out}), Designed for Enhanced Ruggedness
- Typical P_{out} @ 1 dB Compression Point ≈ 45 Watts CW
- Typical GSM EDGE Performance: $V_{DD} = 28$ Volts, $I_{DQ} = 285$ mA, $P_{out} = 17.8$ Watts Avg., Full Frequency Band (920-960 MHz)
Power Gain — 19 dB
Drain Efficiency — 42.5%
Spectral Regrowth @ 400 kHz Offset = -62.5 dBc
Spectral Regrowth @ 600 kHz Offset = -72 dBc
EVM — 2.1% rms

Features

- Characterized with Series Equivalent Large-Signal Impedance Parameters
- Internally Matched for Ease of Use
- Integrated ESD Protection
- Greater Negative Gate-Source Voltage Range for Improved Class C Operation
- 225°C Capable Plastic Package
- RoHS Compliant
- In Tape and Reel. R1 Suffix = 500 Units per 44 mm, 13 inch Reel.

MRFE6S9046NR1
MRFE6S9046GNR1

920-960 MHz, 35.5 W CW, 28 V
GSM, GSM EDGE
LATERAL N-CHANNEL
RF POWER MOSFETs

CASE 1486-03, STYLE 1
TO-270 WB-4
PLASTIC
MRFE6S9046NR1

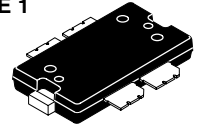

CASE 1487-05, STYLE 1
TO-270 WB-4 GULL
PLASTIC
MRFE6S9046GNR1

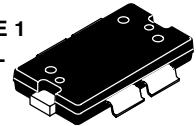

PARTS ARE SINGLE-ENDED

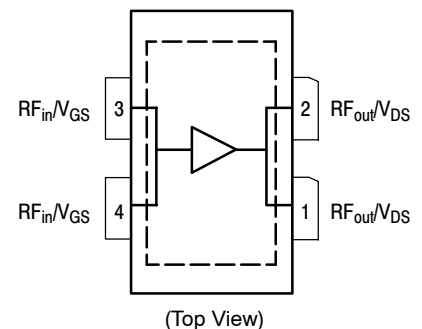

Note: Exposed backside of the package is the source terminal for the transistor.

Figure 1. Pin Connections

Table 1. Maximum Ratings

Rating	Symbol	Value	Unit
Drain-Source Voltage	V_{DSS}	-0.5, +66	Vdc
Gate-Source Voltage	V_{GS}	-6.0, +10	Vdc
Operating Voltage	V_{DD}	32, +0	Vdc
Storage Temperature Range	T_{stg}	- 65 to +150	°C
Case Operating Temperature	T_C	150	°C
Operating Junction Temperature (1,2)	T_J	225	°C

1. Continuous use at maximum temperature will affect MTTF.

2. MTTF calculator available at <http://www.freescale.com/rf>. Select Software & Tools/Development Tools/Calculators to access MTTF calculators by product.

Table 2. Thermal Characteristics

Characteristic	Symbol	Value (1,2)	Unit
Thermal Resistance, Junction to Case Case Temperature 80°C, 45 W CW, 28 Vdc, I _{DQ} = 300 mA Case Temperature 80°C, 18 W CW, 28 Vdc, I _{DQ} = 300 mA	R _{θJC}	1.3 1.8	°C/W

Table 3. ESD Protection Characteristics

Test Methodology	Class
Human Body Model (per JESD22-A114)	1C (Minimum)
Machine Model (per EIA/JESD22-A115)	A (Minimum)
Charge Device Model (per JESD22-C101)	III (Minimum)

Table 4. Moisture Sensitivity Level

Test Methodology	Rating	Package Peak Temperature	Unit
Per JESD22-A113, IPC/JEDEC J-STD-020	3	260	°C

Table 5. Electrical Characteristics (T_C = 25°C unless otherwise noted)

Characteristic	Symbol	Min	Typ	Max	Unit
----------------	--------	-----	-----	-----	------

Off Characteristics

Zero Gate Voltage Drain Leakage Current (V _{DS} = 66 Vdc, V _{GS} = 0 Vdc)	I _{DSS}	—	—	10	μAdc
Zero Gate Voltage Drain Leakage Current (V _{DS} = 28 Vdc, V _{GS} = 0 Vdc)	I _{DSS}	—	—	1	μAdc
Gate-Source Leakage Current (V _{GS} = 5 Vdc, V _{DS} = 0 Vdc)	I _{GSS}	—	—	1	μAdc

On Characteristics

Gate Threshold Voltage (V _{DS} = 10 Vdc, I _D = 100 μAdc)	V _{GS(th)}	1	2.2	3	Vdc
Gate Quiescent Voltage (V _{DD} = 28 Vdc, I _D = 300 mAdc, Measured in Functional Test)	V _{GS(Q)}	2	3.1	4	Vdc
Drain-Source On-Voltage (V _{GS} = 10 Vdc, I _D = 1 Adc)	V _{DS(on)}	0.1	0.3	0.4	Vdc

Dynamic Characteristics ⁽³⁾

Reverse Transfer Capacitance (V _{DS} = 28 Vdc ± 30 mV(rms)ac @ 1 MHz, V _{GS} = 0 Vdc)	C _{rss}	—	0.6	—	pF
Output Capacitance (V _{DS} = 28 Vdc ± 30 mV(rms)ac @ 1 MHz, V _{GS} = 0 Vdc)	C _{oss}	—	318	—	pF
Input Capacitance (V _{DS} = 28 Vdc, V _{GS} = 0 Vdc ± 30 mV(rms)ac @ 1 MHz)	C _{iss}	—	120	—	pF

Functional Tests ⁽⁴⁾ (In Freescale Test Fixture, 50 ohm system) V_{DD} = 28 Vdc, P_{out} = 35.5 W CW, I_{DQ} = 300 mA, f = 960 MHz

Characteristic	Symbol	Min	Typ	Max	Unit
Power Gain	G _{ps}	17.5	19	—	dB
Drain Efficiency	η _D	54	57	—	%
Input Return Loss	IRL	—	-13	-7	dB

1. MTTF calculator available at <http://www.freescale.com/rf>. Select Software & Tools/Development Tools/Calculators to access MTTF calculators by product.
2. Refer to AN1955, *Thermal Measurement Methodology of RF Power Amplifiers*. Go to <http://www.freescale.com/rf>. Select Documentation/Application Notes - AN1955.
3. Part internally matched both on input and output.
4. Measurement made with device in straight lead configuration before any lead forming operation is applied.

(continued)

Table 5. Electrical Characteristics ($T_C = 25^\circ\text{C}$ unless otherwise noted) (continued)

Characteristic	Symbol	Min	Typ	Max	Unit
Typical Performances (In Freescale GSM EDGE Reference Design Test Fixture, 50 ohm system) $V_{DD} = 28\text{ Vdc}$, $I_{DQ} = 300\text{ mA}$, 920-960 MHz Bandwidth					
P_{out} @ 1 dB Compression Point	P1dB	—	45	—	W
IMD Symmetry @ 44 W PEP, P_{out} where IMD Third Order Intermodulation $\cong 30\text{ dBc}$ (Delta IMD Third Order Intermodulation between Upper and Lower Sidebands $> 2\text{ dB}$)	IMD _{sym}	—	55	—	MHz
VBW Resonance Point (IMD Third Order Intermodulation Inflection Point)	VBW _{res}	—	65	—	MHz
Gain Flatness in 40 MHz Bandwidth @ $P_{out} = 35.5\text{ W CW}$	G_F	—	0.2	—	dB
Average Deviation from Linear Phase in 40 MHz Bandwidth @ $P_{out} = 45\text{ W CW}$	Φ	—	0.9	—	°
Average Group Delay @ $P_{out} = 45\text{ W CW}$, $f = 940\text{ MHz}$	Delay	—	3.1	—	ns
Part-to-Part Insertion Phase Variation @ $P_{out} = 45\text{ W CW}$, $f = 940\text{ MHz}$, Six Sigma Window	$\Delta\Phi$	—	20	—	°
Gain Variation over Temperature (-30°C to $+85^\circ\text{C}$)	ΔG	—	0.021	—	dB/°C
Output Power Variation over Temperature (-30°C to $+85^\circ\text{C}$)	ΔP_{1dB}	—	0.006	—	dBm/°C

Typical GSM EDGE Performances (In Freescale GSM EDGE Reference Design Test Fixture, 50 ohm system) $V_{DD} = 28\text{ Vdc}$, $I_{DQ} = 285\text{ mA}$, $P_{out} = 17.8\text{ W Avg.}$, 920-960 MHz EDGE Modulation

Power Gain	G_{ps}	—	19	—	dB
Drain Efficiency	η_D	—	42.5	—	%
Error Vector Magnitude	EVM	—	2.1	—	% rms
Spectral Regrowth at 400 kHz Offset	SR1	—	-62.5	—	dBc
Spectral Regrowth at 600 kHz Offset	SR2	—	-72	—	dBc

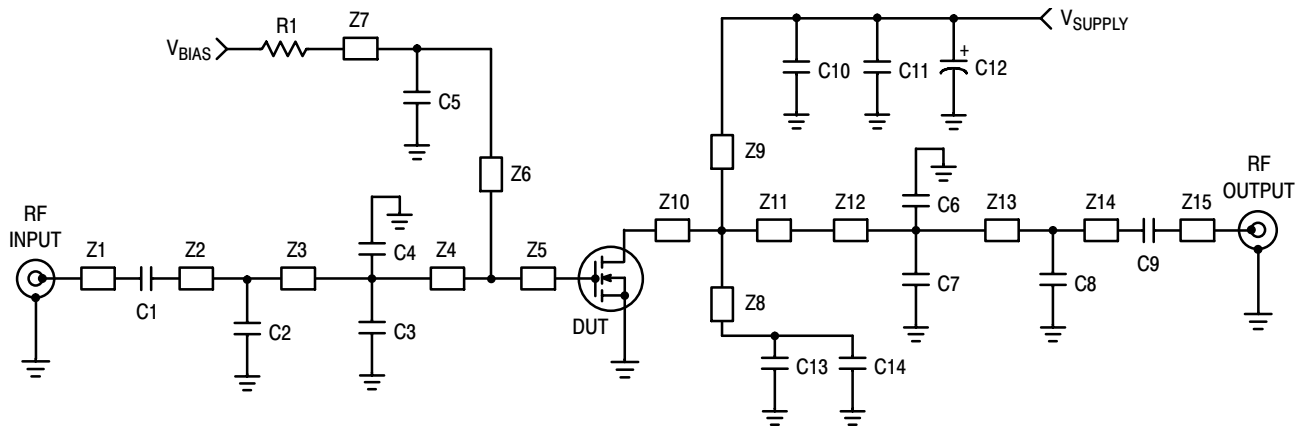

Z1 0.200" x 0.044" Microstrip
 Z2 0.196" x 0.044" Microstrip
 Z3 0.380" x 0.044" Microstrip
 Z4 0.321" x 0.450" Microstrip
 Z5 0.039" x 0.450" Microstrip
 Z6* 0.281" x 0.040" Microstrip
 Z7 0.892" x 0.051" Microstrip
 Z8* Z9* 0.751" x 0.040" Microstrip

Z10 0.040" x 0.450" Microstrip
 Z11 0.321" x 0.450" Microstrip
 Z12 0.080" x 0.280" Microstrip
 Z13 0.372" x 0.044" Microstrip
 Z14 0.124" x 0.044" Microstrip
 Z15 0.200" x 0.044" Microstrip
 PCB Rogers R04350, 0.020", $\epsilon_r = 3.66$

* Line length includes microstrip bends

Figure 2. MRFE6S9046NR1(GNR1) Test Circuit Schematic — GSM EDGE Reference Design

Table 6. MRFE6S9046NR1(GNR1) Test Circuit Component Designations and Values — GSM EDGE Reference Design

Part	Description	Part Number	Manufacturer
C1, C9	56 pF Chip Capacitors	ATC600F560BT500XT	ATC
C2	2.4 pF Chip Capacitor	ATC600F2R4BT500XT	ATC
C3, C4	6.8 pF Chip Capacitors	ATC600F6R8BT500XT	ATC
C5, C11, C14	10 μ F, 50 V Chip Capacitors	GRM55DR61H106KA88B	Murata
C6, C7	3.3 pF Chip Capacitors	ATC600F3R3BT500XT	ATC
C8	4.7 pF Chip Capacitor	ATC600F4R7BT500XT	ATC
C10, C13	39 pF Chip Capacitors	ATC600F390BT500XT	ATC
C12	470 μ F, 63 V Electrolytic Capacitor	MCGPR63V477M13X26-RH	Multicomp
R1	4.7 K Ω , 1/4 W Chip Resistor	CRCW12064701FKEA	Vishay

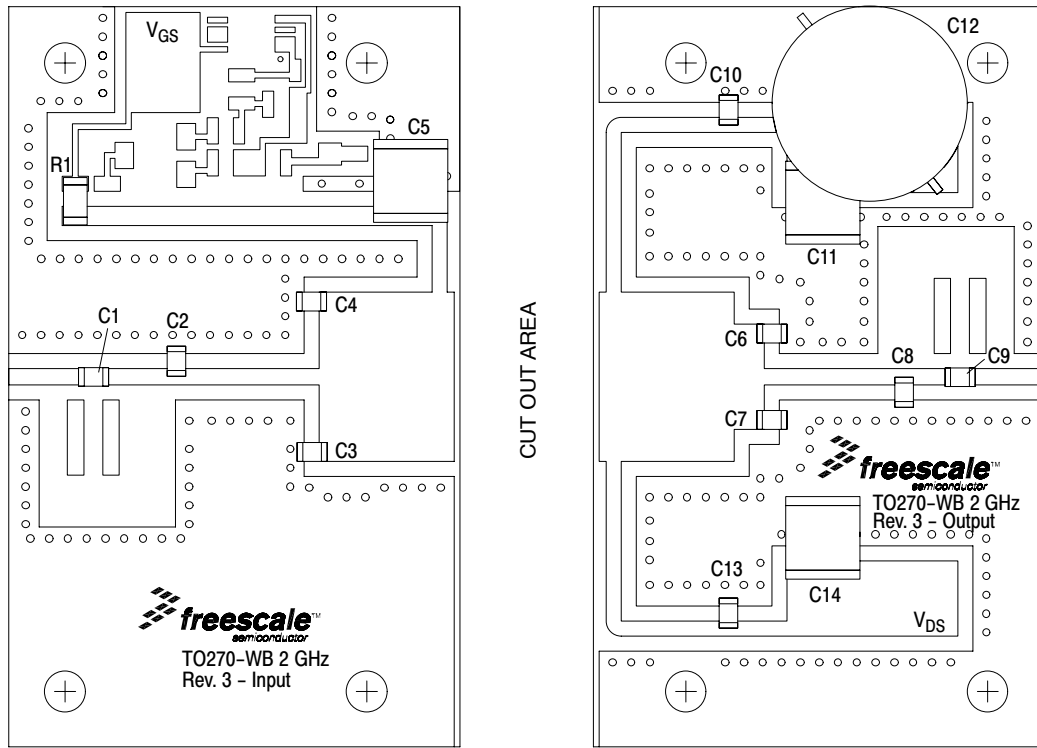

Figure 3. MRFE6S9046NR1(GNR1) Test Circuit Component Layout — GSM EDGE Reference Design

TYPICAL CHARACTERISTICS

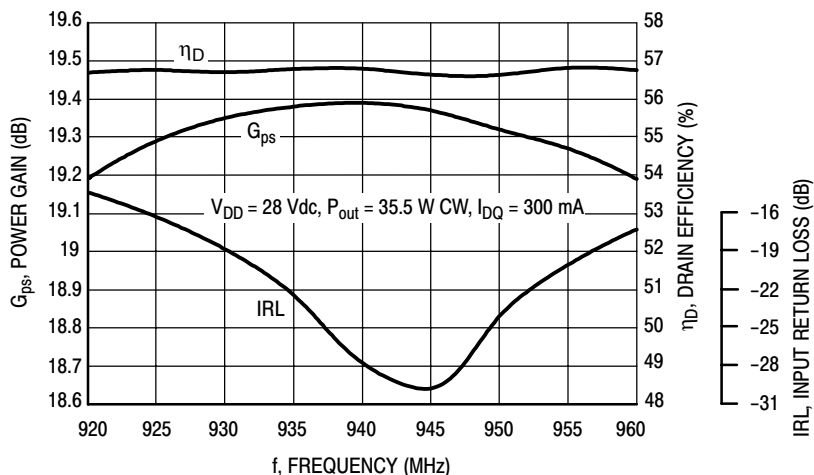

Figure 4. Power Gain, Input Return Loss and Drain Efficiency versus Frequency @ $P_{out} = 35.5$ Watts CW

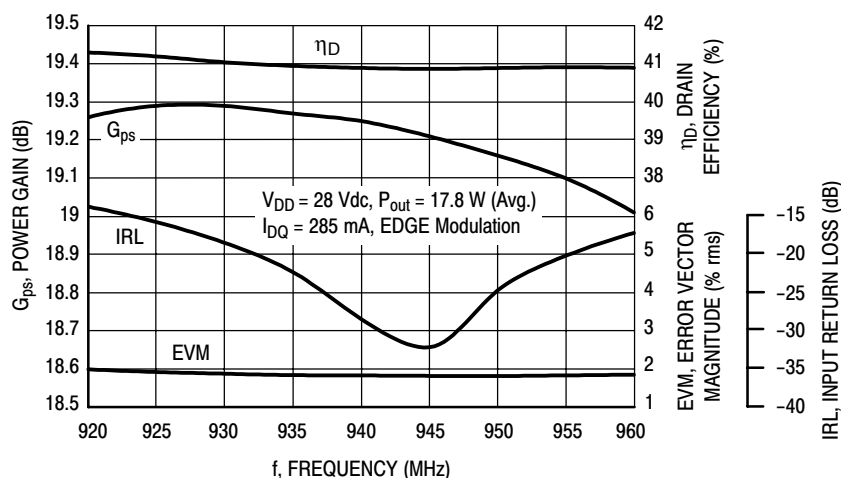

Figure 5. Power Gain, Input Return Loss, EVM and Drain Efficiency versus Frequency @ $P_{out} = 17.8$ Watts Avg.

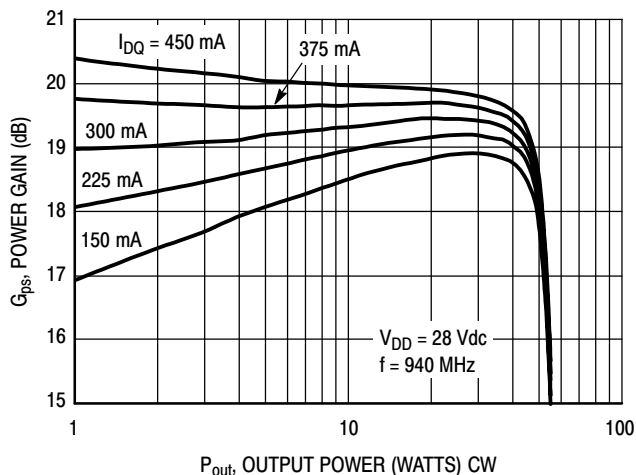

Figure 6. Power Gain versus Output Power

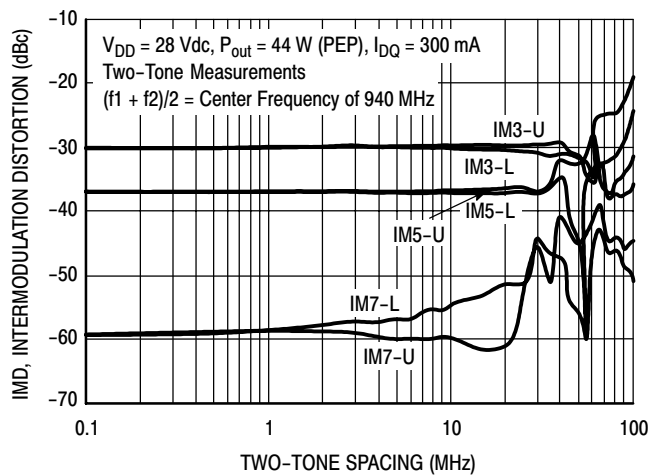

Figure 7. Intermodulation Distortion Products versus Two-Tone Spacing

TYPICAL CHARACTERISTICS

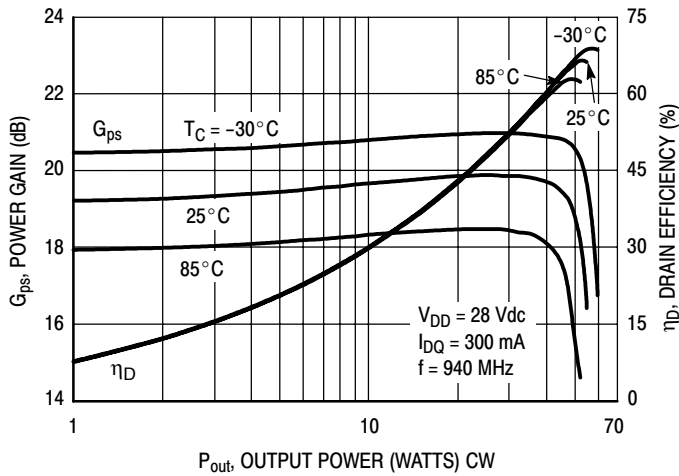

Figure 8. Power Gain and Drain Efficiency versus Output Power

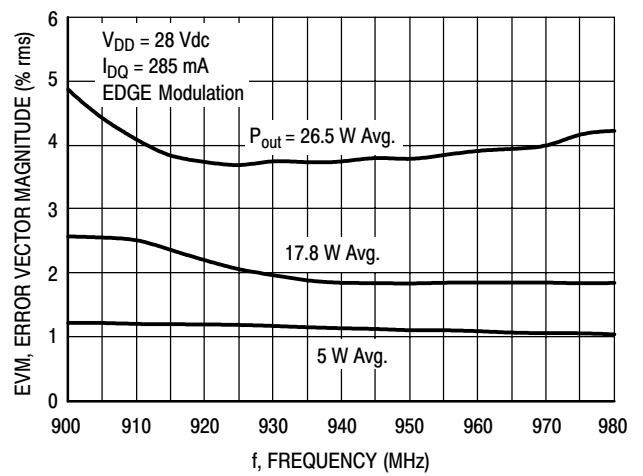

Figure 9. EVM versus Frequency

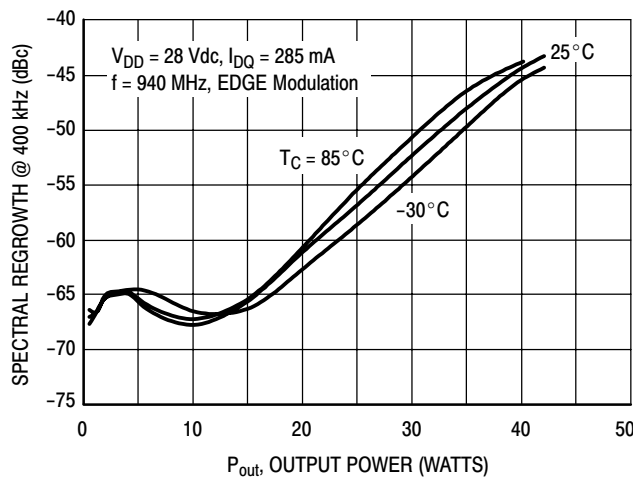

Figure 10. Spectral Regrowth at 400 kHz versus Output Power

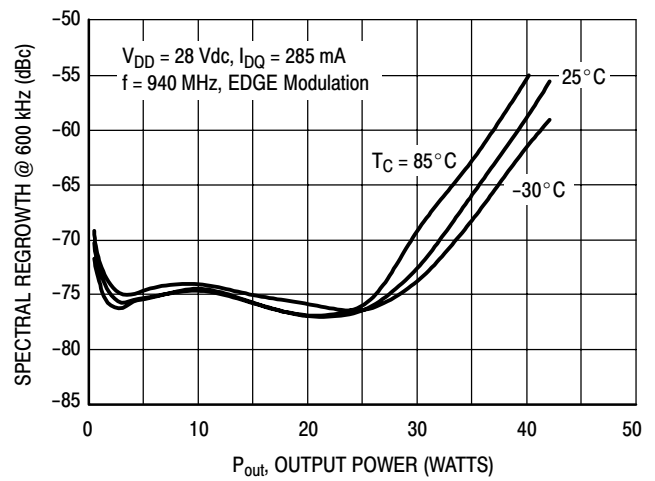

Figure 11. Spectral Regrowth at 600 kHz versus Output Power

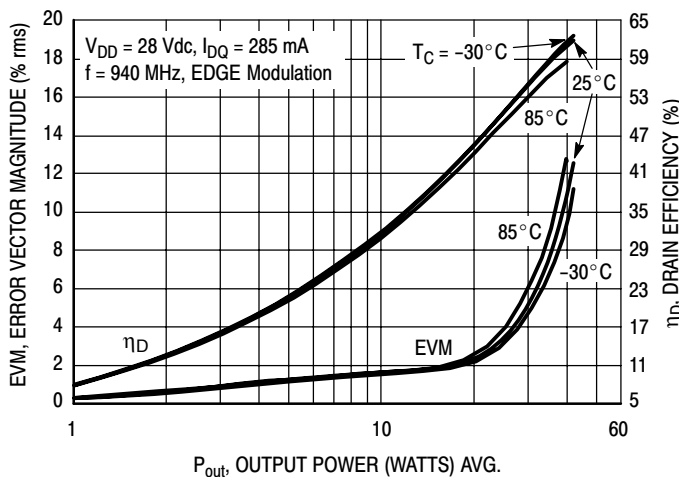

Figure 12. EVM and Drain Efficiency versus Output Power

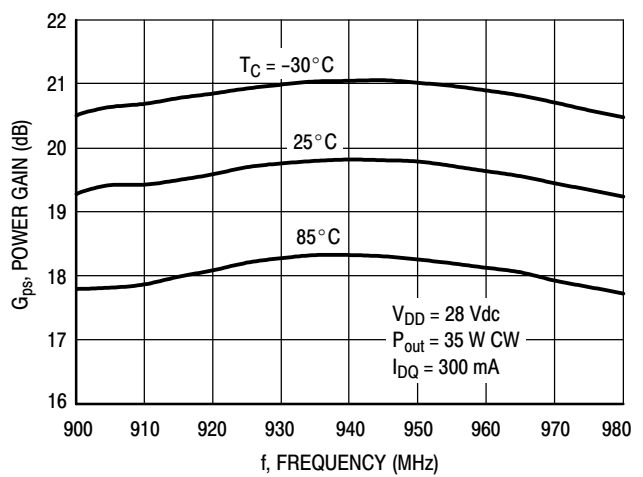

Figure 13. Power Gain versus Frequency

TYPICAL CHARACTERISTICS

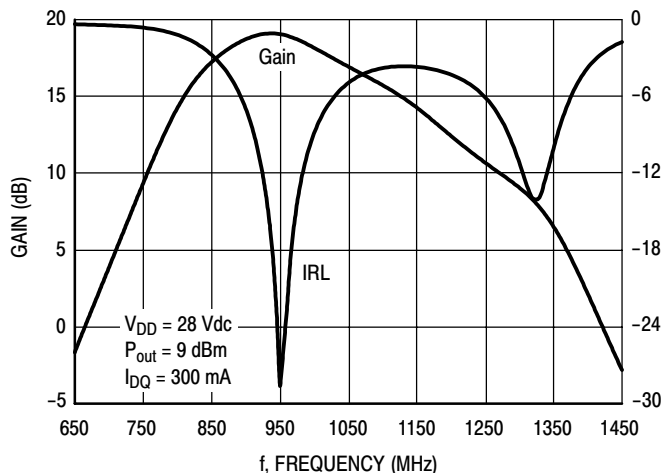
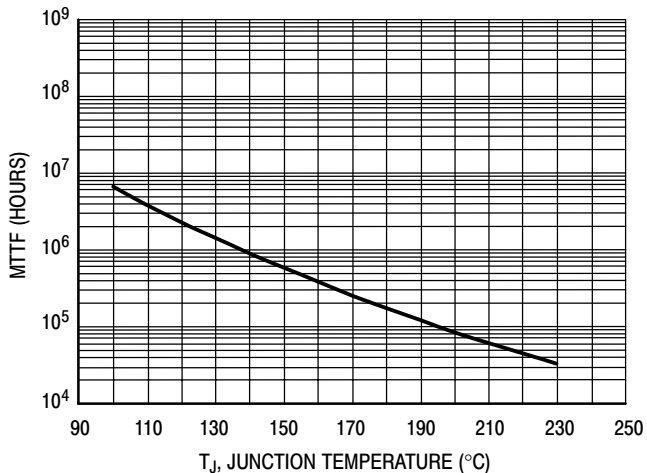

Figure 14. Broadband Frequency Response



This above graph displays calculated MTTF in hours when the device is operated at $V_{DD} = 28 \text{ Vdc}$, $P_{out} = 35.5 \text{ W CW}$, and $\eta_D = 57\%$.

MTTF calculator available at <http://www.freescale.com/rf>. Select Software & Tools/Development Tools/Calculators to access MTTF calculators by product.

Figure 15. MTTF versus Junction Temperature

GSM TEST SIGNAL

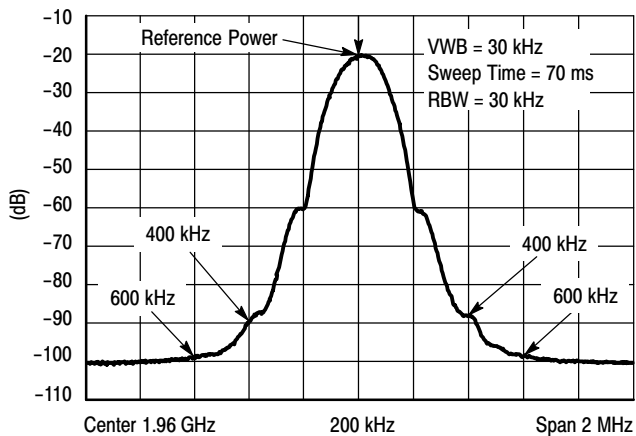
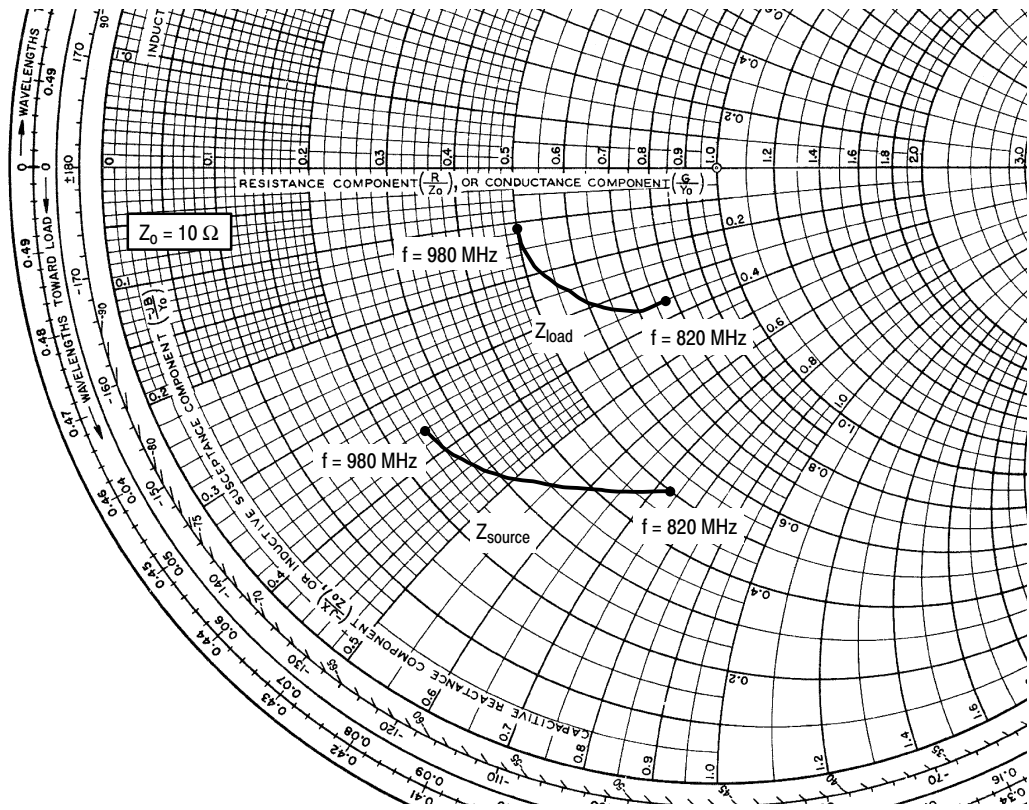

Figure 16. EDGE Spectrum



$V_{DD} = 28 \text{ Vdc}$, $I_{DQ} = 285 \text{ mA}$, $P_{out} = 17.8 \text{ W Avg.}$

f (MHz)	Z_{source} Ω	Z_{load} Ω
820	5.03 - j7.29	7.68 - j3.45
840	4.46 - j6.69	6.97 - j3.53
860	4.00 - j6.11	6.42 - j3.20
880	3.62 - j5.64	5.98 - j2.87
900	3.29 - j5.18	5.65 - j2.52
920	3.03 - j4.75	5.40 - j2.17
940	2.80 - j4.36	5.21 - j1.82
960	2.61 - j3.99	5.09 - j1.47
980	2.46 - j3.64	5.03 - j1.12

Z_{source} = Test circuit impedance as measured from gate to ground.

Z_{load} = Test circuit impedance as measured from drain to ground.

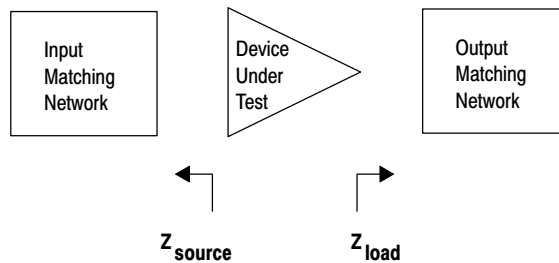
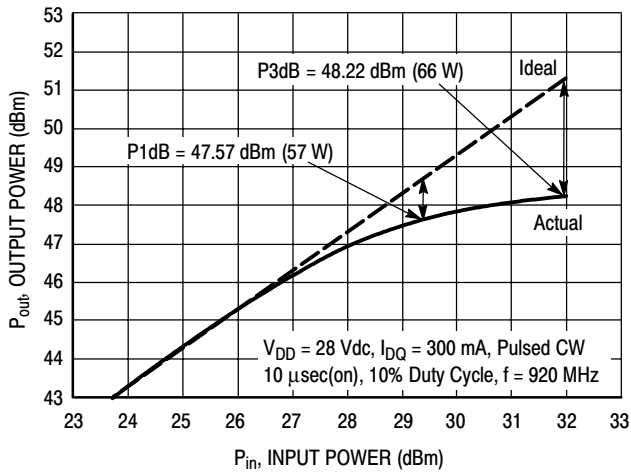

Figure 17. Series Equivalent Source and Load Impedance — GSM EDGE Reference Design

ALTERNATIVE PEAK TUNE LOAD PULL CHARACTERISTICS



NOTE: Load Pull Test Fixture Tuned for Peak P1dB Output Power @ 28 V

Test Impedances per Compression Level

	Z_{source} Ω	Z_{load} Ω
P1dB	7.83 - j2.01	1.25 - j0.52

Figure 18. Pulsed CW Output Power versus Input Power @ 28 V @ 920 MHz

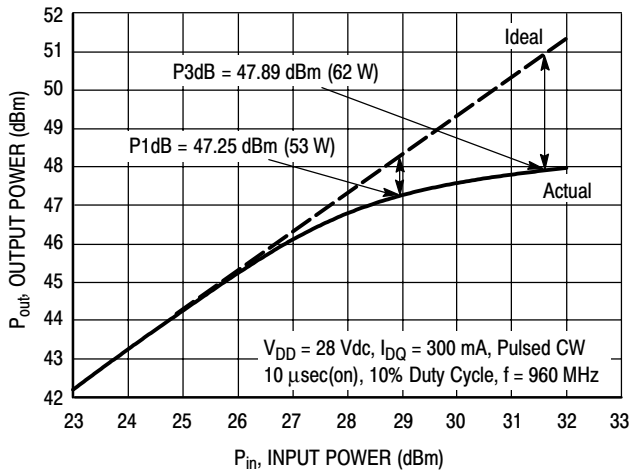

NOTE: Load Pull Test Fixture Tuned for Peak P1dB Output Power @ 28 V

Test Impedances per Compression Level

	Z_{source} Ω	Z_{load} Ω
P1dB	3.79 - j6.51	4.30 - j2.52

Figure 19. Pulsed CW Output Power versus Input Power @ 28 V @ 960 MHz

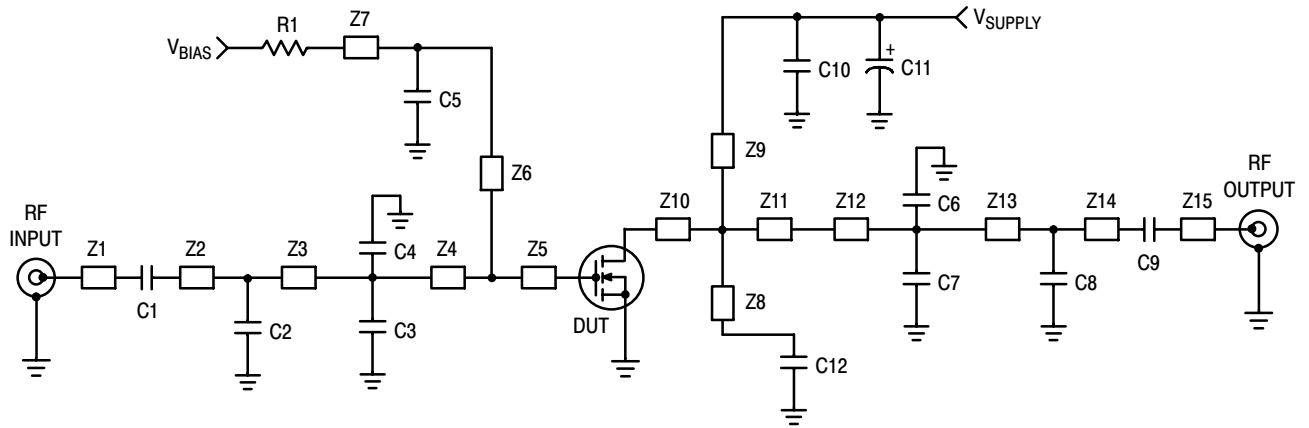

Z1	1.320" x 0.044" Microstrip
Z2	0.020" x 0.044" Microstrip
Z3	0.378" x 0.044" Microstrip
Z4	0.321" x 0.450" Microstrip
Z5	0.039" x 0.450" Microstrip
Z6*	0.306" x 0.040" Microstrip
Z7	0.708" x 0.051" Microstrip
Z8*, Z9*	0.738" x 0.040" Microstrip

Z10	0.040" x 0.450" Microstrip
Z11	0.321" x 0.450" Microstrip
Z12	0.080" x 0.280" Microstrip
Z13	0.371" x 0.044" Microstrip
Z14	0.124" x 0.044" Microstrip
Z15	1.332" x 0.044" Microstrip
PCB	Rogers R04350, 0.020", $\epsilon_r = 3.66$

* Line length includes microstrip bends

Figure 20. MRFE6S9046NR1(GNR1) Test Circuit Schematic — Production Test Fixture

Table 7. MRFE6S9046NR1(GNR1) Test Circuit Component Designations and Values — Production Test Fixture

Part	Description	Part Number	Manufacturer
C1, C9	56 pF Chip Capacitors	ATC600F560BT500XT	ATC
C2	3.9 pF Chip Capacitor	ATC600F2R4BT500XT	ATC
C3, C4	6.8 pF Chip Capacitors	ATC600F6R8BT500XT	ATC
C5	0.01 μ F Chip Capacitor	C1825C103K1GAC	Kemet
C6, C7	3.3 pF Chip Capacitors	ATC600F3R3BT500XT	ATC
C8	5.1 pF Chip Capacitor	ATC600F4R7BT500XT	ATC
C10, C12	39 pF Chip Capacitors	ATC600F390BT500XT	ATC
C11	470 μ F, 63 V Electrolytic Capacitor	MCGPR63V477M13X26 - RH	Multicomp
R1	4.7 K Ω , 1/4 W Chip Resistor	CRCW12064K70FKEA	Vishay

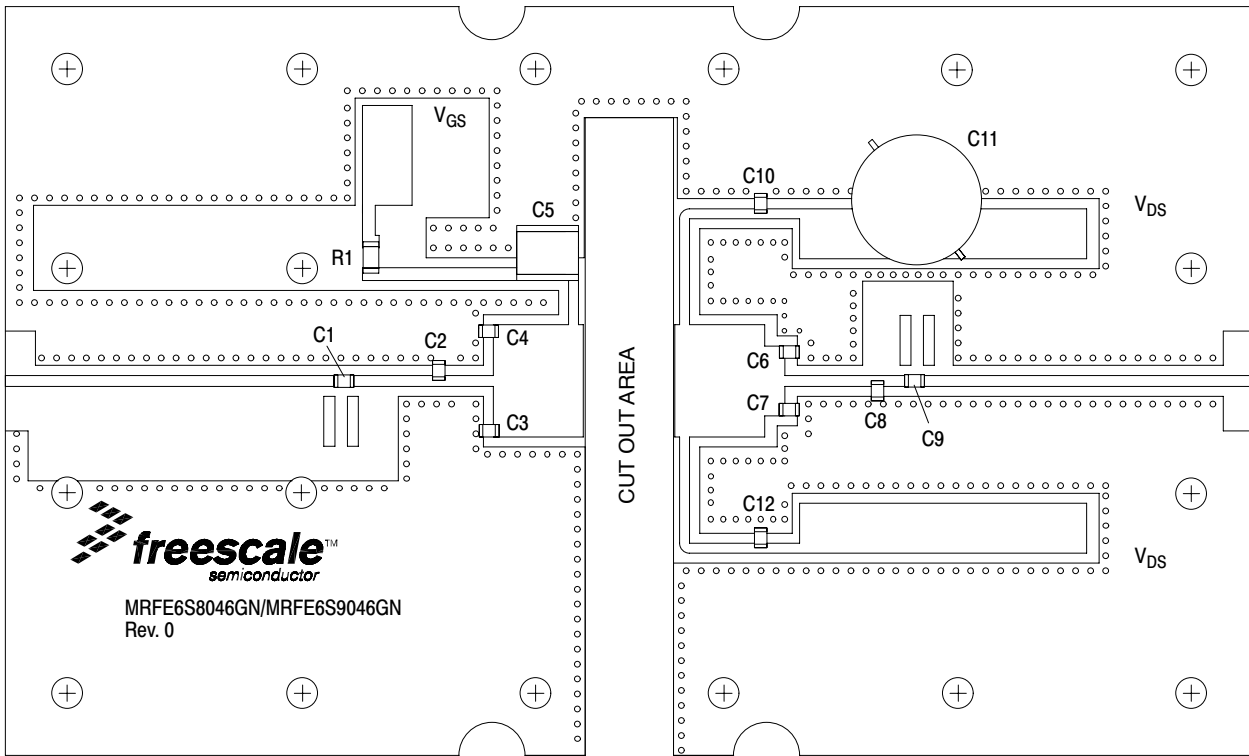
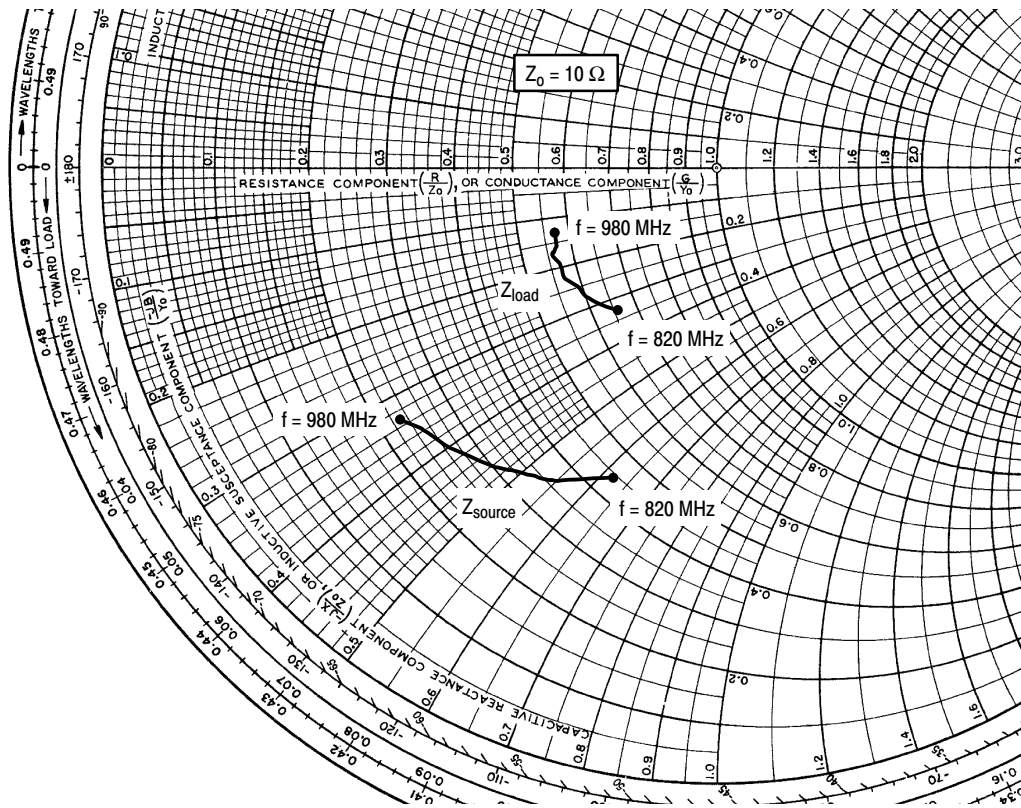

Figure 21. MRFE6S9046NR1(GNR1) Test Circuit Component Layout — Production Test Fixture



$V_{DD} = 28 \text{ Vdc}$, $I_{DQ} = 300 \text{ mA}$, $P_{out} = 35.5 \text{ W CW}$

f (MHz)	Z_{source} Ω	Z_{load} Ω
820	4.37 - j6.23	6.55 - j3.27
840	3.95 - j5.76	6.26 - j2.98
860	3.60 - j5.53	6.02 - j2.72
880	3.29 - j4.95	5.86 - j2.48
900	3.04 - j4.59	5.74 - j2.24
920	2.83 - j4.24	5.68 - j1.98
940	2.63 - j3.92	5.64 - j1.74
960	2.45 - j3.62	5.65 - j1.49
980	2.31 - j3.33	5.70 - j1.26

Z_{source} = Test circuit impedance as measured from gate to ground.

Z_{load} = Test circuit impedance as measured from drain to ground.

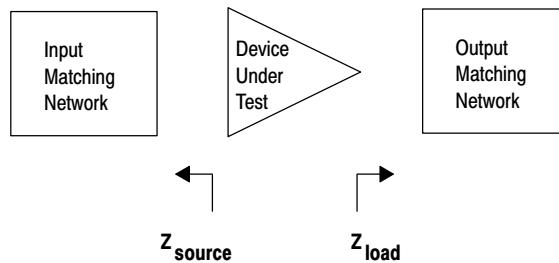
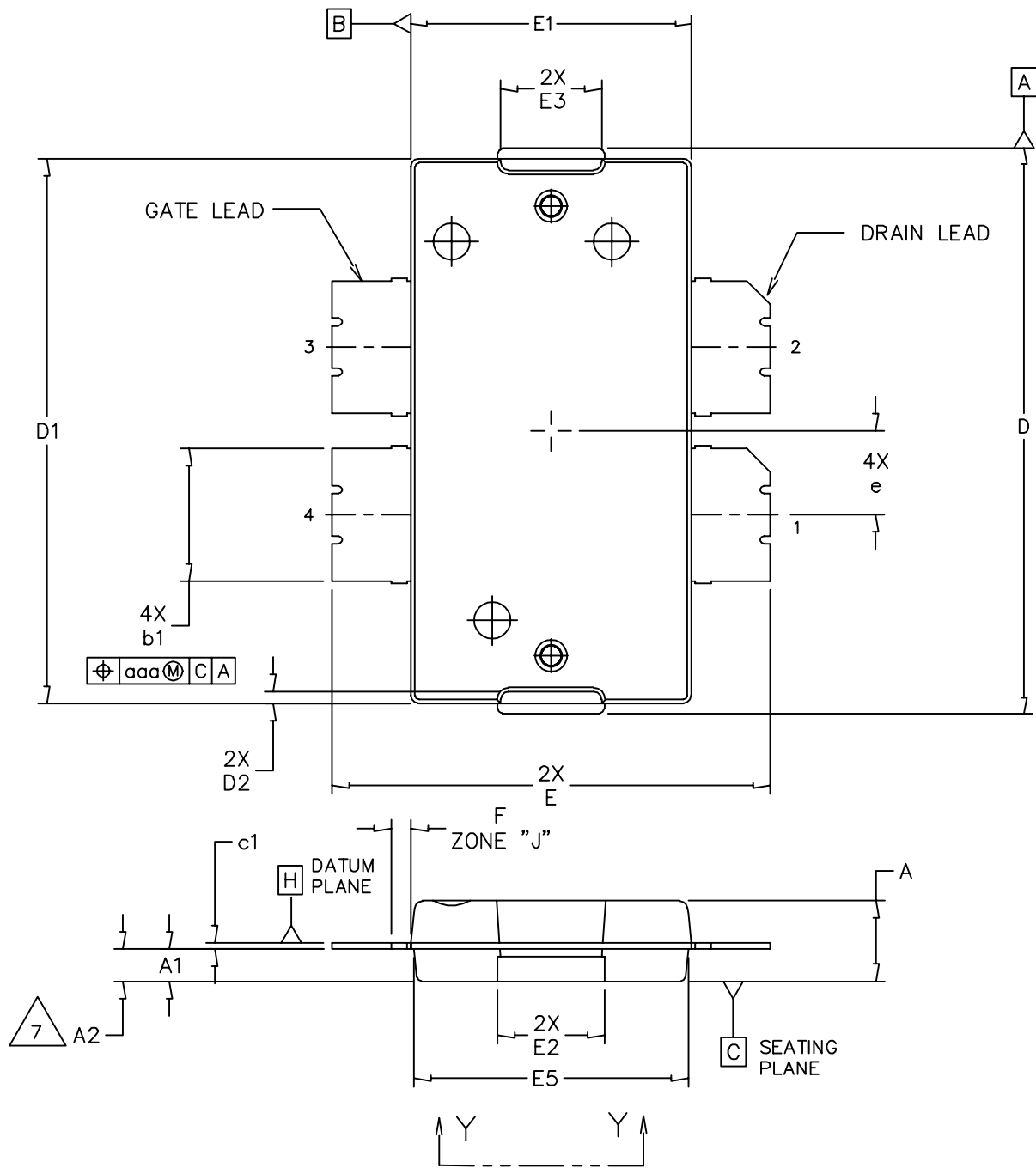
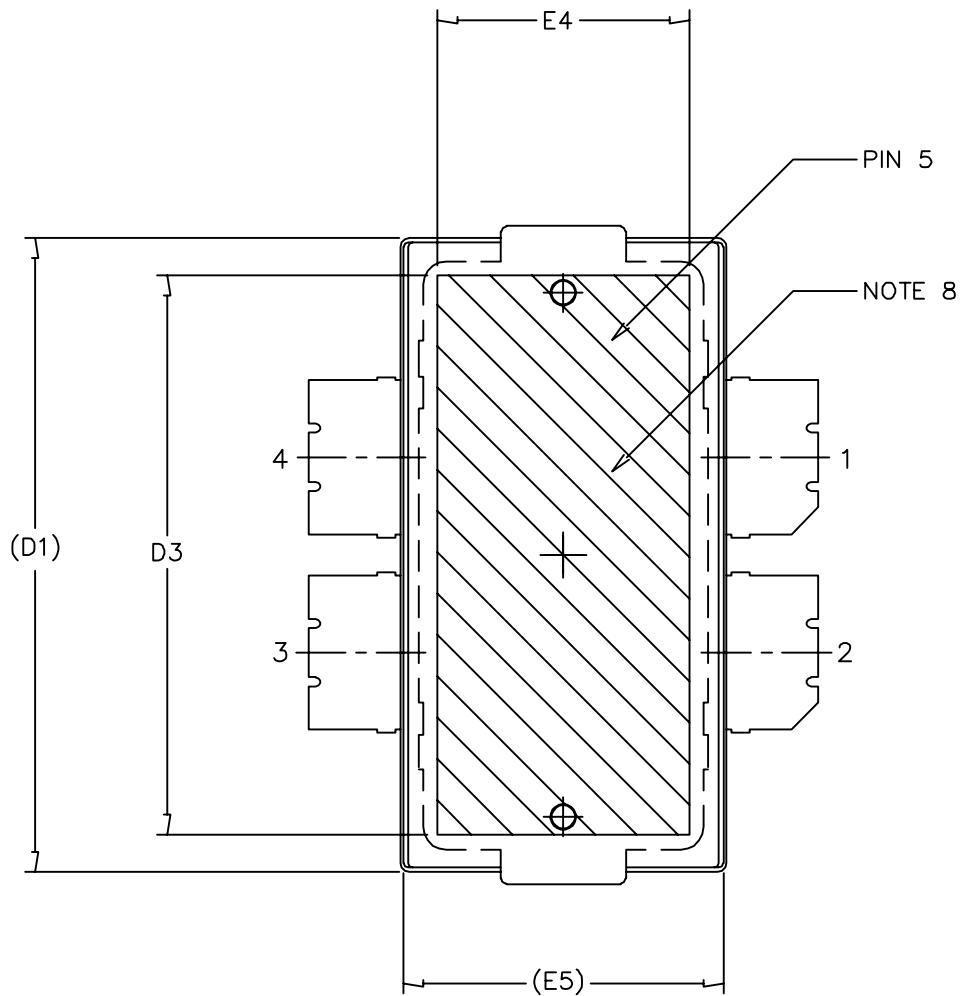

Figure 22. Series Equivalent Source and Load Impedance — Production Test Fixture

PACKAGE DIMENSIONS



© FREESCALE SEMICONDUCTOR, INC. ALL RIGHTS RESERVED.	MECHANICAL OUTLINE	PRINT VERSION NOT TO SCALE
TITLE: <div style="text-align: center; padding: 5px;"> TO-270 4 LEAD, WIDE BODY </div>	DOCUMENT NO: 98ASA10577D	REV: D
	CASE NUMBER: 1486-03	13 AUG 2007
	STANDARD: NON-JEDEC	



© FREESCALE SEMICONDUCTOR, INC. ALL RIGHTS RESERVED.	MECHANICAL OUTLINE	PRINT VERSION NOT TO SCALE	
TITLE: TO-270 4 LEAD, WIDE BODY		DOCUMENT NO: 98ASA10577D	REV: D
		CASE NUMBER: 1486-03	13 AUG 2007
		STANDARD: NON-JEDEC	

MRFE6S9046NR1 MRFE6S9046GNR1

NOTES:

1. CONTROLLING DIMENSION: INCH
2. INTERPRET DIMENSIONS AND TOLERANCES PER ASME Y14.5M-1994.
3. DATUM PLANE -H- IS LOCATED AT THE TOP OF LEAD AND IS COINCIDENT WITH THE LEAD WHERE THE LEAD EXITS THE PLASTIC BODY AT THE TOP OF THE PARTING LINE.
4. DIMENSIONS "D" AND "E1" DO NOT INCLUDE MOLD PROTRUSION. ALLOWABLE PROTRUSION IS .006 PER SIDE. DIMENSIONS "D" AND "E1" DO INCLUDE MOLD MISMATCH AND ARE DETERMINED AT DATUM PLANE -H-.
5. DIMENSIONS "b1" DOES NOT INCLUDE DAMBAR PROTRUSION. ALLOWABLE DAMBAR PROTRUSION SHALL BE .005 TOTAL IN EXCESS OF THE "b1" DIMENSION AT MAXIMUM MATERIAL CONDITION.
6. DATUMS -A- AND -B- TO BE DETERMINED AT DATUM PLANE -H-.
7. DIMENSION A2 APPLIES WITHIN ZONE "J" ONLY.
8. HATCHING REPRESENTS THE EXPOSED AREA OF THE HEAT SLUG.

STYLE 1:
 PIN 1 - DRAIN PIN 2 - DRAIN
 PIN 3 - GATE PIN 4 - GATE
 PIN 5 - SOURCE

DIM	INCH		MILLIMETER		DIM	INCH		MILLIMETER	
	MIN	MAX	MIN	MAX		MIN	MAX	MIN	MAX
A	.100	.104	2.54	2.64	F	.025 BSC		0.64 BSC	
A1	.039	.043	0.99	1.09	b1	.164	.170	4.17	4.32
A2	.040	.042	1.02	1.07	c1	.007	.011	.18	.28
D	.712	.720	18.08	18.29	e	.106 BSC		2.69 BSC	
D1	.688	.692	17.48	17.58	aaa	.004		.10	
D2	.011	.019	0.28	0.48					
D3	.600	---	15.24	---					
E	.551	.559	14	14.2					
E1	.353	.357	8.97	9.07					
E2	.132	.140	3.35	3.56					
E3	.124	.132	3.15	3.35					
E4	.270	---	6.86	---					
E5	.346	.350	8.79	8.89					
© FREESCALE SEMICONDUCTOR, INC. ALL RIGHTS RESERVED.			MECHANICAL OUTLINE			PRINT VERSION NOT TO SCALE			
TITLE: TO-270 4 LEAD WIDE BODY					DOCUMENT NO: 98ASA10577D			REV: D	
					CASE NUMBER: 1486-03			13 AUG 2007	
					STANDARD: NON-JEDEC				

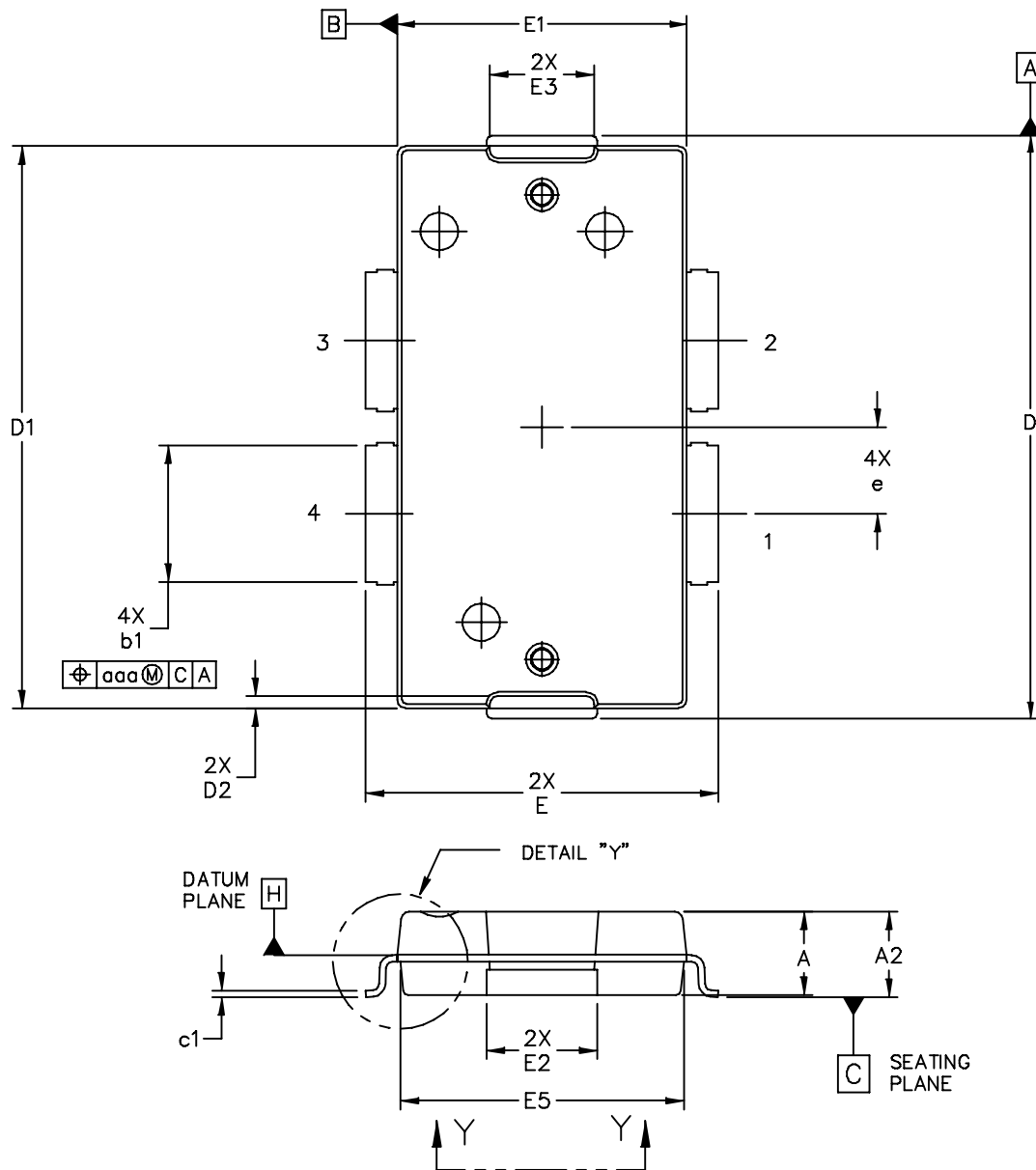

© FREESCALE SEMICONDUCTOR, INC. ALL RIGHTS RESERVED.	MECHANICAL OUTLINE	PRINT VERSION NOT TO SCALE	
TITLE: TO-270 4 LEAD, WIDE BODY GULL WING	DOCUMENT NO: 98ASA10578D	REV: D	
	CASE NUMBER: 1487-05	03 AUG 2007	
	STANDARD: JEDEC TO-270 BB		

MRFE6S9046NR1 MRFE6S9046GNR1

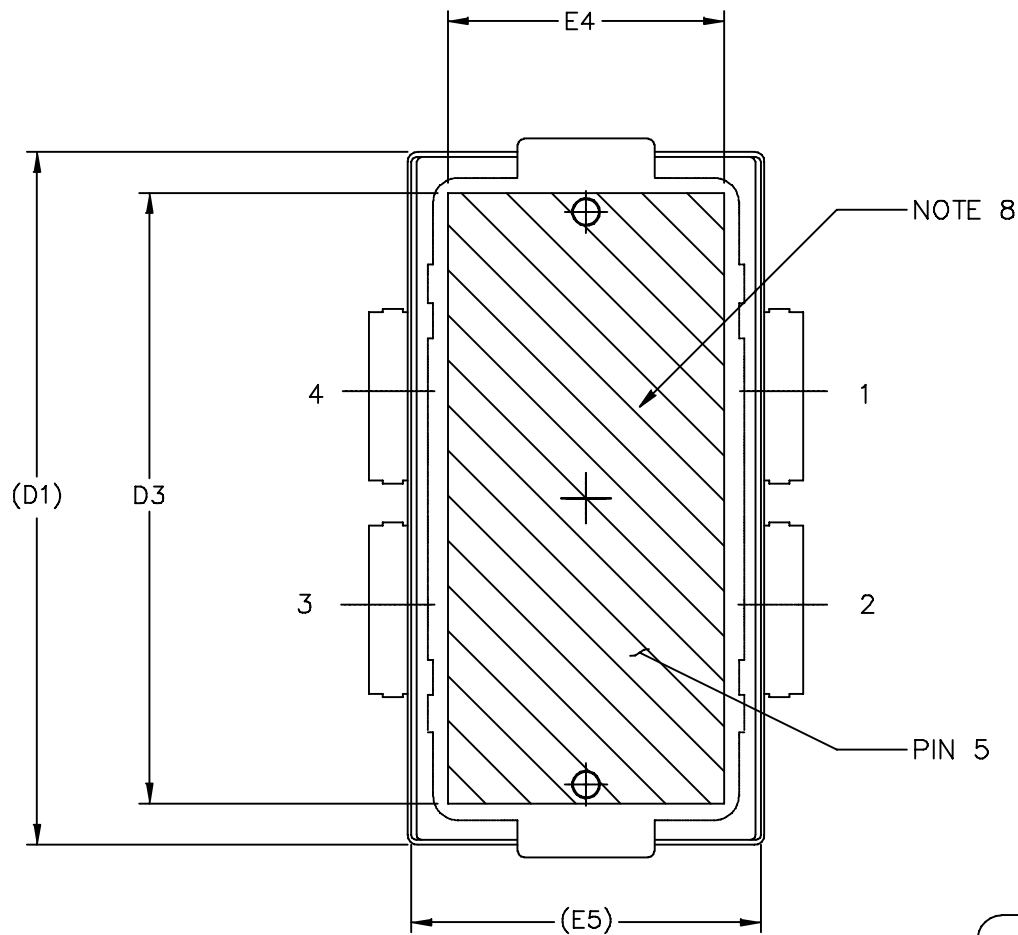

VIEW Y-Y

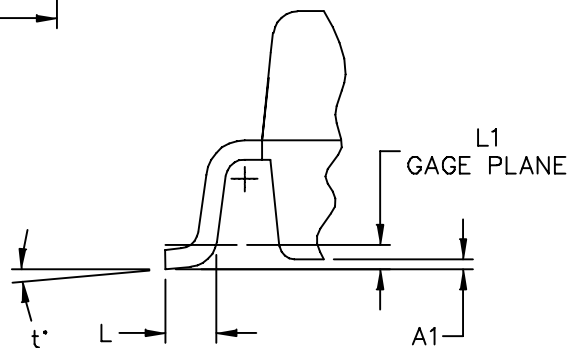

DETAIL "Y"

© FREESCALE SEMICONDUCTOR, INC. ALL RIGHTS RESERVED.	MECHANICAL OUTLINE	PRINT VERSION NOT TO SCALE	
TITLE: TO-270 4 LEAD, WIDE BODY GULL WING	DOCUMENT NO: 98ASA10578D	REV: D	
	CASE NUMBER: 1487-05	03 AUG 2007	
	STANDARD: JEDEC TO-270 BB		

NOTES:

1. CONTROLLING DIMENSION: INCH
2. INTERPRET DIMENSIONS AND TOLERANCES PER ASME Y14.5M-1994.
3. DATUM PLANE -H- IS LOCATED AT THE TOP OF LEAD AND IS COINCIDENT WITH THE LEAD WHERE THE LEAD EXITS THE PLASTIC BODY AT THE TOP OF THE PARTING LINE.
4. DIMENSIONS "D" AND "E1" DO NOT INCLUDE MOLD PROTRUSION. ALLOWABLE PROTRUSION IS .006 (0.15) PER SIDE. DIMENSIONS "D" AND "E1" DO INCLUDE MOLD MISMATCH AND ARE DETERMINED AT DATUM PLANE -H-.
5. DIMENSION "b1" DOES NOT INCLUDE DAMBAR PROTRUSION. ALLOWABLE DAMBAR PROTRUSION SHALL BE .005 (0.13) TOTAL IN EXCESS OF THE "b1" DIMENSION AT MAXIMUM MATERIAL CONDITION.
6. HATCHING REPRESENTS THE EXPOSED AREA OF THE HEAT SLUG.

STYLE 1:

- PIN 1 - DRAIN
- PIN 2 - DRAIN
- PIN 3 - GATE
- PIN 4 - GATE
- PIN 5 - SOURCE

DIM	INCH		MILLIMETER		DIM	INCH		MILLIMETER	
	MIN	MAX	MIN	MAX		MIN	MAX	MIN	MAX
A	.100	.104	2.54	2.64	L	.018	.024	0.46	0.61
A1	.001	.004	0.02	0.10	L1	.01 BSC		0.25 BSC	
A2	.101	.108	2.56	2.74	b1	.164	.170	4.17	4.32
D	.712	.720	18.08	18.29	c1	.007	.011	.18	.28
D1	.688	.692	17.48	17.58	e	.106 BSC		2.69 BSC	
D2	.011	.019	0.28	0.48	t	2'	8'	2'	8'
D3	.600	----	15.24	----	aaa	.004		0.1	
E	.429	.437	10.90	11.10					
E1	.353	.357	8.97	9.07					
E2	.132	.140	3.35	3.56					
E3	.124	.132	3.15	3.35					
E4	.270	----	6.86	----					
E5	.346	.350	8.79	8.89					

© FREESCALE SEMICONDUCTOR, INC. ALL RIGHTS RESERVED.		MECHANICAL OUTLINE		PRINT VERSION NOT TO SCALE	
TITLE: TO-270 4 LEAD, WIDE BODY GULL WING			DOCUMENT NO: 98ASA10578D		REV: D
			CASE NUMBER: 1487-05		03 AUG 2007
			STANDARD: JEDEC TO-270 BB		

PRODUCT DOCUMENTATION

Refer to the following documents to aid your design process.

Application Notes

- AN1955: Thermal Measurement Methodology of RF Power Amplifiers

Engineering Bulletins

- EB212: Using Data Sheet Impedances for RF LDMOS Devices

REVISION HISTORY

The following table summarizes revisions to this document.

Revision	Date	Description
0	May 2009	<ul style="list-style-type: none">• Initial Release of Data Sheet

How to Reach Us:

Home Page:

www.freescale.com

Web Support:

<http://www.freescale.com/support>

USA/Europe or Locations Not Listed:

Freescale Semiconductor, Inc.
Technical Information Center, EL516
2100 East Elliot Road
Tempe, Arizona 85284
1-800-521-6274 or +1-480-768-2130
www.freescale.com/support

Europe, Middle East, and Africa:

Freescale Halbleiter Deutschland GmbH
Technical Information Center
Schatzbogen 7
81829 Muenchen, Germany
+44 1296 380 456 (English)
+46 8 52200080 (English)
+49 89 92103 559 (German)
+33 1 69 35 48 48 (French)
www.freescale.com/support

Japan:

Freescale Semiconductor Japan Ltd.
Headquarters
ARCO Tower 15F
1-8-1, Shimo-Meguro, Meguro-ku,
Tokyo 153-0064
Japan
0120 191014 or +81 3 5437 9125
support.japan@freescale.com

Asia/Pacific:

Freescale Semiconductor China Ltd.
Exchange Building 23F
No. 118 Jianguo Road
Chaoyang District
Beijing 100022
China
+86 10 5879 8000
support.asia@freescale.com

For Literature Requests Only:

Freescale Semiconductor Literature Distribution Center
1-800-441-2447 or +1-303-675-2140
Fax: +1-303-675-2150
LDCForFreescaleSemiconductor@hibbertgroup.com

Information in this document is provided solely to enable system and software implementers to use Freescale Semiconductor products. There are no express or implied copyright licenses granted hereunder to design or fabricate any integrated circuits or integrated circuits based on the information in this document.

Freescale Semiconductor reserves the right to make changes without further notice to any products herein. Freescale Semiconductor makes no warranty, representation or guarantee regarding the suitability of its products for any particular purpose, nor does Freescale Semiconductor assume any liability arising out of the application or use of any product or circuit, and specifically disclaims any and all liability, including without limitation consequential or incidental damages. "Typical" parameters that may be provided in Freescale Semiconductor data sheets and/or specifications can and do vary in different applications and actual performance may vary over time. All operating parameters, including "Typicals", must be validated for each customer application by customer's technical experts. Freescale Semiconductor does not convey any license under its patent rights nor the rights of others. Freescale Semiconductor products are not designed, intended, or authorized for use as components in systems intended for surgical implant into the body, or other applications intended to support or sustain life, or for any other application in which the failure of the Freescale Semiconductor product could create a situation where personal injury or death may occur. Should Buyer purchase or use Freescale Semiconductor products for any such unintended or unauthorized application, Buyer shall indemnify and hold Freescale Semiconductor and its officers, employees, subsidiaries, affiliates, and distributors harmless against all claims, costs, damages, and expenses, and reasonable attorney fees arising out of, directly or indirectly, any claim of personal injury or death associated with such unintended or unauthorized use, even if such claim alleges that Freescale Semiconductor was negligent regarding the design or manufacture of the part.

Freescale™ and the Freescale logo are trademarks of Freescale Semiconductor, Inc. All other product or service names are the property of their respective owners.

© Freescale Semiconductor, Inc. 2009. All rights reserved.

