

PNP Epitaxial Silicon Transistor

www.DataSheet4U.com

AUDIO FREQUENCY AMPLIFIER
HIGH FREQUENCY OSC.

- Complement to PJC945

ABSOLUTE MAXIMUM RATINGS (Ta = 25 °C)

Characteristic	Symbol	Rating	Unit
Collector-Base Voltage	V _{CBO}	-50	V
Collector-Emitter Voltage	V _{CEO}	-45	V
Emitter-Base Voltage	V _{EBO}	-5	V
Collector Current	I _c	-100	mA
Collector Dissipation	P _C	450	mW
Junction Temperature	T _j	150	°C
Storage Temperature	T _{stg}	-55 ~150	°C

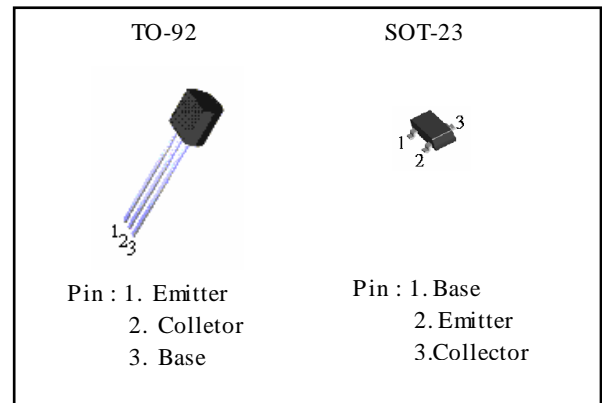

ORDERING INFORMATION

Device	Operating Temperature	Package
PJA733CT	-20°C ~+85°C	TO-92
PJA733CX		SOT-23

ELECTRICAL CHARACTERISTICS (Ta = 25 °C)

Characteristic	Symbol	Test Condition	Min	Typ	Max	Unit
Collector-Base Breakdown Voltage	BV _{CBO}	I _c = -100μA, I _E = 0	-50			V
Collector-Emitter Breakdown Voltage	BV _{CEO}	I _c = -1.0mA, I _B = 0	-40			V
Emitter-Base Breakdown Voltage	BV _{EBO}	I _E = -100μA, I _C = 0	-5			V
Collector Cutoff Current	I _{CBO}	V _{CB} = 45V, I _E = 0			-50	nA
Emitter Cutoff Current	I _{EBO}	V _{EB} = 3V, I _C = 0			-50	nA
Collector-Cutoff Current	I _{CEO}	V _{CE} = 40V, I _B = 0				
DC Current Gain	h _{FE}	V _{CE} = 6V, I _c = 1.0 mA	70	200	700	
Collector-Emitter Saturation Voltage	V _{CE(SAT)}	I _C = -100mA, I _B = -5mA		-0.2	-0.7	V
Base-Emitter Saturation Voltage	V _{BE(SAT)}	I _C = -100mA, I _B = -5mA		-0.82	-1.0	V
Base-Emitter On Voltage	V _{BE(on)}	I _C = -2mA, V _{CE} = -5V	-0.6	-0.65	-0.75	V
Current-Gain-Bandwidth Product	f _T	V _{CE} = -5V, I _C = -10mA	100	190		MHz
Output Capacitance	C _{Ob}	f = 1MHz		4.5	7.0	pF
Noise Figure	NF	V _{CB} = -10V, I _E = 0 V _{CE} = -5V, I _C = -0.2mA f = 1KHz, R _S = 1KΩ		0.7	10	dB

h_{FE} (2) CLASSIFICATION

Classification	R	Q	P	K
h _{FE}	70-140	120-240	200-400	350-700

www.DataSheet4U.com

STATIC CHARACTERISTIC

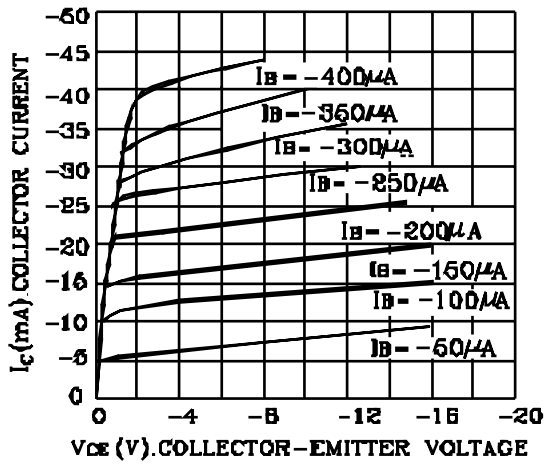

BASE-EMITTER VOLTAGE

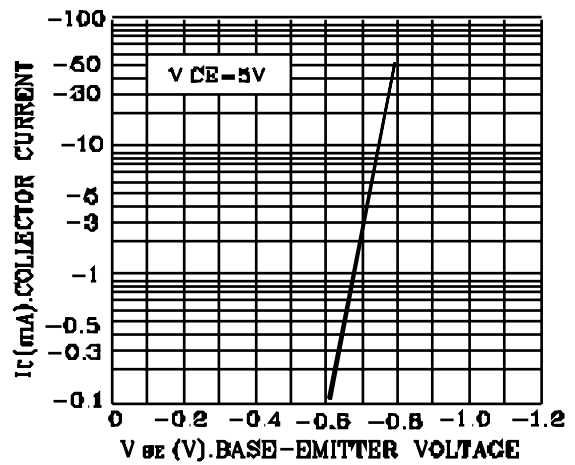

DC CURRENT GAIN

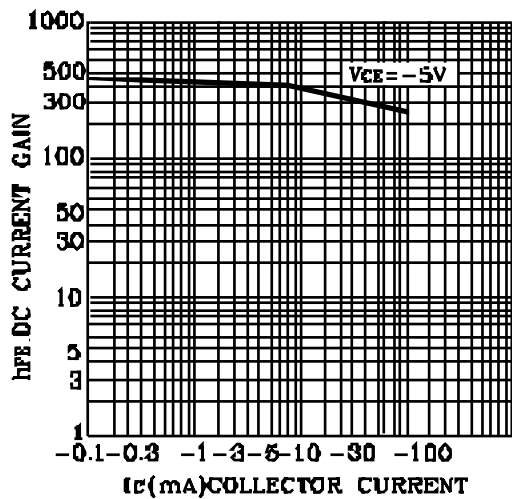

CURRENT GAIN-BANDWIDTH PRODUCT

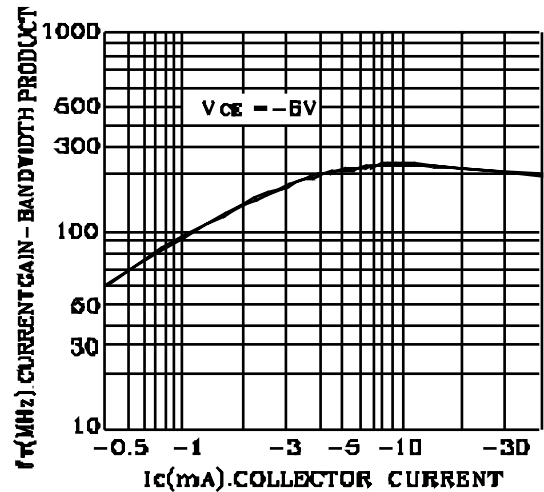

BASE-EMITTER SATURATION VOLTAGE
COLLECTOR-EMITTER SATURATION VOLTAGE

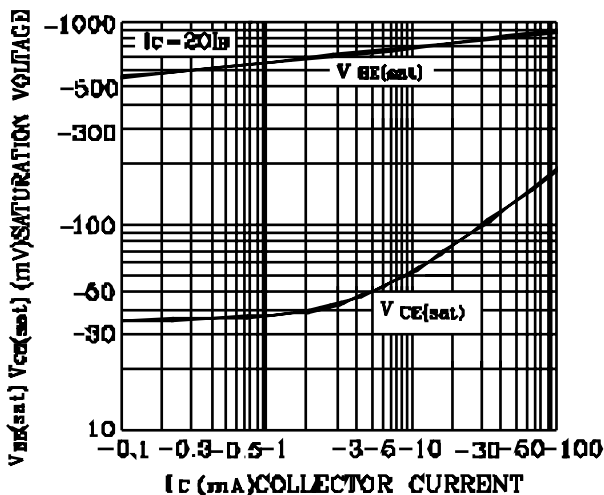

COLLECTOR OUTPUT CAPACITANCE

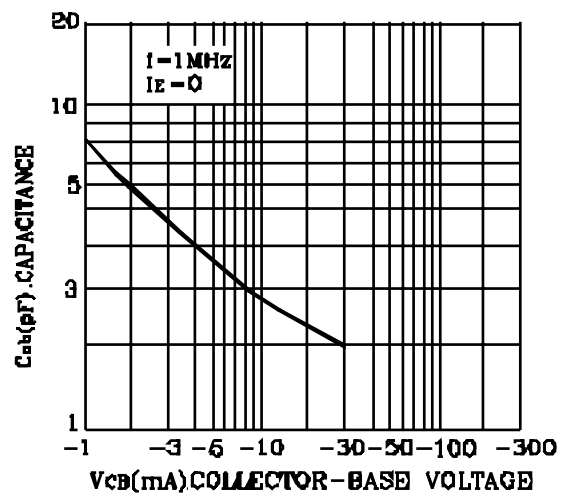

www.DataSheet4U.com

TO-92 Unit:mm

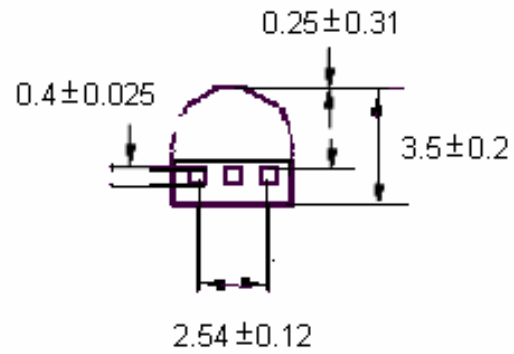
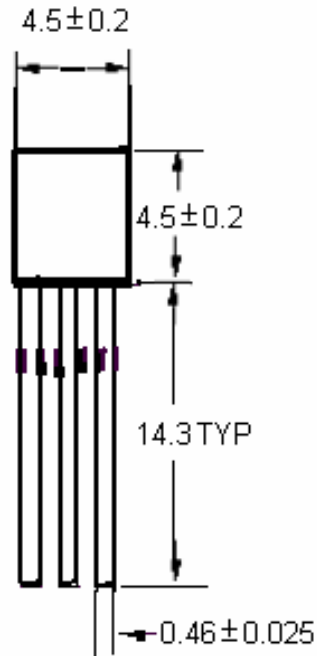

SOT-23 Unit:mm

