

Panasonic®

Operating Instructions

Digital Video Camera

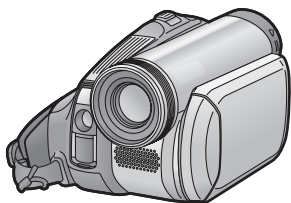

Model No. **NV-GS37EB**
NV-GS27EB



	NV-GS37EB	NV-GS27EB
DV IN	—	—
Video Light	●	—

Mini **DV** PAL

www.DataSheet4U.com

Before use, please read these instructions completely.



Web Site: <http://www.panasonic-europe.com>

LSQT1006 A

Dear Customer,

We would like to take this opportunity to thank you for purchasing this Panasonic Movie Camera. Please read these Operating Instructions carefully and keep them handy for future reference. Please note that the actual controls and components, menu items, etc. of your Movie Camera may look somewhat different from those shown in the illustrations in these Operating Instructions.

Information for Your Safety

As this equipment gets hot during use, operate it in well ventilated place; do not install this equipment in a confined space such as a bookcase or similar unit.

To reduce the risk of fire, electric shock or product damage, do not expose this equipment to rain, moisture, dripping or splashing and ensure that no objects filled with liquids, such as vases, shall be placed on the equipment.

AC Adaptor



- The rating plate is on the underside of the AC Adaptor.

Caution for AC mains lead

For your safety, please read the following text carefully.

This appliance is supplied with a moulded three-pin mains plug for your safety and convenience. A 5-ampere fuse is fitted in this plug.

Should the fuse need to be replaced, please ensure that the replacement fuse has a rating of 5-amperes and it is approved by ASTA or BSI to BS1362.

Check for the ASTA mark  or the BSI mark  on the body of the fuse.

If the plug contains a removable fuse cover you must ensure that it is refitted when the fuse is replaced. If you lose the fuse cover, the plug must not be used until a replacement cover is obtained. A replacement fuse cover can be purchased from your local Panasonic Dealer.

IF THE FITTED MOULDED PLUG IS UNSUITABLE FOR THE SOCKET OUTLET IN YOUR HOME THEN THE FUSE SHOULD BE REMOVED AND THE PLUG CUT OFF AND DISPOSED OF SAFELY.

THERE IS A DANGER OF SEVERE ELECTRICAL SHOCK IF THE CUT OFF PLUG IS INSERTED INTO ANY 13-AMPERE SOCKET.

If a new plug is to be fitted, please observe the wiring code as shown below.

If in any doubt, please consult a qualified electrician.

IMPORTANT

The wires in this mains lead are coloured in accordance with the following code:

Blue: Neutral
Brown: Live

As the colours of the wires in the mains lead of this appliance may not correspond with the coloured markings identifying the terminals in your plug, proceed as follows:

The wire which is coloured BLUE must be connected to the terminal in the plug which is marked with the letter N or coloured BLACK.

The wire which is coloured BROWN must be connected to the terminal in the plug which is marked with the letter L or coloured RED.

Under no circumstances should either of these wires be connected to the earth terminal of the three-pin plug, marked with the letter E or the Earth Symbol .

Before Use

Remove the Connector Cover.

How to replace the Fuse

The location of the fuse differ according to the type of AC mains plug (figures A and B). Confirm the AC mains plug fitted and follow the instructions below.

Illustrations may differ from actual AC mains plug.
1) Open the fuse cover with a screwdriver.

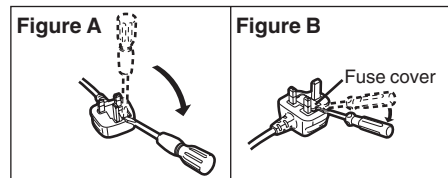

2) Replace the fuse and close or attach the fuse cover.

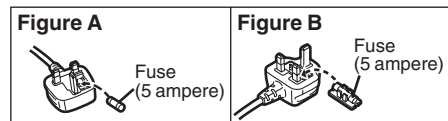

Operating Instructions

- These Operating Instructions apply to models NV-GS37 and NV-GS27.
- The illustrations used in these Operating Instructions show model NV-GS37, however, parts of the explanation refer to different models.
- Depending on the model, some functions are not available.
- Windows is a trademark or registered trademark of Microsoft Corporation U.S.A.
- All other company and product names in the operating instructions are trademarks of their respective corporations.

Pages for reference

Pages for reference are indicated by dashes either side of a number, for example: -00-

The menu operation flow is indicated by >> in the description.

Use only the recommended accessories.

- Do not use any other AV cables and USB cables except the supplied one.
- When you use the cable which are sold separately, please make sure to use the one whose length is less than 3 meters.

■ WARNING

**Do not remove the cover (or back); there are no user serviceable parts inside.
Refer servicing to qualified service personnel.**

■ Carefully observe copyright laws.

Recording of pre-recorded tapes or discs or other published or broadcast material for purposes other than your own private use may infringe copyright laws. Even for the purpose of private use, recording of certain material may be restricted.

- The Movie Camera uses copyright-protected technologies and is protected by the patented technologies and intellectual properties of Japan and the U.S. To use these copyright-protected technologies, authorization of the Macrovision Company is required. It is prohibited to disassemble or modify the Movie Camera.

Information on Disposal for Users of Waste Electrical & Electronic Equipment (private households)



This symbol on the products and/or accompanying documents means that used electrical and electronic products should not be mixed with general household waste.

For proper treatment, recovery and recycling, please take these products to designated collection points, where they will be accepted on a free of charge basis. Alternatively, in some countries you may be able to return your products to your local retailer upon the purchase of an equivalent new product.

Disposing of this product correctly will help to save valuable resources and prevent any potential negative effects on human health and the environment which could otherwise arise from inappropriate waste handling.

Please contact your local authority for further details of your nearest designated collection point.

Penalties may be applicable for incorrect disposal of this waste, in accordance with national legislation.

For business users in the European Union

If you wish to discard electrical and electronic equipment, please contact your dealer or supplier for further information.

Information on Disposal in other Countries outside the European Union

This symbol is only valid in the European Union.

If you wish to discard this product, please contact your local authorities or dealer and ask for the correct method of disposal.

Contents

Information for Your Safety.....	2
----------------------------------	---

Before using

Accessories	5
Optional	5
Parts identification and handling.....	6
Fitting the lens cap	7
The grip belt.....	7
Power supply	8
Charging time and recordable time.....	9
Turning the camera on.....	9
Setting date and time.....	10
Using the LCD monitor	11
Using the viewfinder	11
Quick start.....	12
Inserting/removing a cassette.....	13
Selecting a mode.....	14
How to use the joystick.....	14
Help mode	15
Switching the language.....	16
Using the menu screen.....	16
Adjusting LCD monitor/viewfinder.....	17
Using the remote control (NV-GS37 only)	18
Recording with the built-in LED video light (NV-GS37 only).....	20

Record mode

Check before recording	21
Recording on a tape	22
Recording check.....	22
Blank search function	23
Recording a still picture on a tape (Photoshot).....	23
Zoom in/out function	24
Recording yourself.....	24
Backlight compensation function	25
Colour Night view function	25
Soft skin mode.....	25
Fade in/fade out function	26
Wind noise reduction function.....	26
Recording images for wide-screen TVs.....	26
Image stabilizer function	27
Recording in various situations (Scene mode).....	27
Recording in natural colours (White balance).....	28
Manual focus adjustment.....	29
Manual shutter speed/aperture adjustment.....	30

Playback mode

Playing back tape.....	31
Slow-motion playback/frame-by-frame playback.....	32
Variable-speed search function (NV-GS37 only)	32
Playback on TV	33

Edit mode

Copying onto a DVD recorder or a VCR (Dubbing)	34
Using the DV Cable for Recording (Digital Dubbing)	35
Audio dubbing (NV-GS37 only)	35

Menu

Menu list.....	37
Menus related to taking pictures	38
Menus related to playback	38
Other menus.....	38

Others

Indications	39
Warning/alarm indications	40
Functions cannot be used simultaneously.....	41
Before requesting repair (Problems and solutions)	42
Cautions for Use.....	45
Explanation of terms.....	48

Specifications

Specifications	50
Index.....	51

Before using

■ Sales and Support Information

Customer Care Centre

- For customers within the UK: 08705 357357
- For customers within the Republic of Ireland: 01 289 8333
- Visit our website for product information
- E-mail: customer.care@panasonic.co.uk

Technical Support for AV Software

- For UK, ROI: 08701 505610

Direct Sales at Panasonic UK

- Order accessory and consumable items for your product with ease and confidence by phoning our Customer Care Centre Monday–Thursday 9.00 a.m.–5.30 p.m., Friday 9.30 a.m.–5.30 p.m. (Excluding public holidays)
- Or go on line through our Internet Accessory ordering application at www.panasonic.co.uk.
- Most major credit and debit cards accepted.
- All enquiries transactions and distribution facilities are provided directly by Panasonic UK Ltd.
- It couldn't be simpler!
- Also available through our Internet is direct shopping for a wide range of finished products, take a browse on our website for further details.

Accessories

The followings are the accessories supplied with this product.

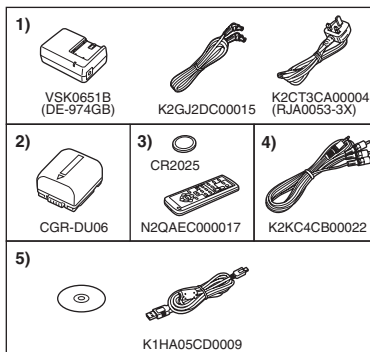

- 1) **AC adaptor, DC input lead, AC mains lead** -8-
- 2) **Battery pack** -8-
 - The supplied battery pack is not available as spare part, see the list of optional batteries below for alternative battery.
- 3) **Remote control, button-type battery (supplied with NV-GS37)** -18-
- 4) **AV cable** -34-
- 5) **USB cable and CD-ROM (supplied with NV-GS37)**

Optional

- 1) AC adaptor (VW-AD11EB)
 - 2) Battery pack (lithium/CGR-DU06/640mAh)
 - 3) Battery pack (lithium/CGA-DU07/680mAh)
 - 4) Battery pack (lithium/CGA-DU12/1150mAh)
 - 5) Battery pack (lithium/CGA-DU14/1360mAh)
 - 6) Battery pack (lithium/CGA-DU21/2040mAh)
 - 7) Wide conversion lens (VW-LW3007E)
 - 8) Tele conversion lens (VW-LT3014E)
 - 9) ND filter (VW-LND30E)
 - 10) MC protector (VW-LMC30E)
 - 11) Tripod (VW-CT45E)
 - 12) DV cable (VW-CD1E)
- Some optional accessories may not be available in some countries.

Parts identification and handling

■ Camera

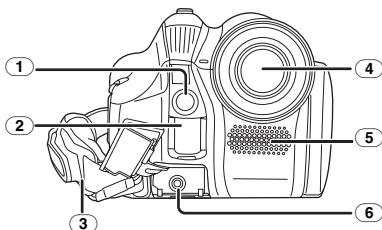

- ① **Built-in LED video light (NV-GS37 only)** -20-
- ② **White balance sensor** -29-
Remote control sensor (NV-GS37 only) -19-
- ③ **Grip belt** -7-
- ④ **Lens**
 - Fit the MC protector (VW-LMC30E; optional), the ND filter (VW-LND30E; optional), the tele conversion lens (VW-LT3014E; optional) or the wide conversion lens (VW-LW3007E; optional) in front of the lens. Do not fit the other accessories. (except for the lens cap)
- ⑤ **Microphone (built-in, stereo)** -24-, -26-
- ⑥ **Audio-video output terminal [A/V]** -34-

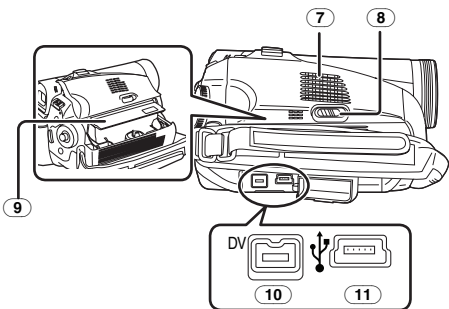

- ⑦ **Speaker** -31-
- ⑧ **Cassette eject lever [OPEN/EJECT]** -13-
- ⑨ **Cassette holder** -13-
- ⑩ **DV terminal [DV]** -34-, -35-
- ⑪ **USB terminal [⏏]**

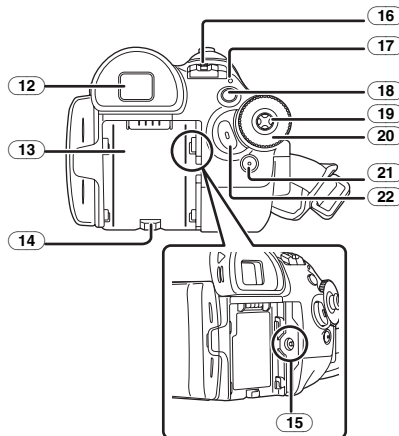

- ⑫ **Viewfinder** -11-, -48-

Due to limitations in LCD production technology, there may be some tiny bright or dark spots on the Viewfinder screen. However, this is not a malfunction and does not affect the recorded picture.

- ⑬ **Battery holder** -8-
- ⑭ **Battery release lever [BATTERY RELEASE]** -8-
- ⑮ **DC input terminal [DC/C.C.IN]** -8-
- ⑯ **Power switch [OFF/ON]** -9-
- ⑰ **Status indicator** -9-
- ⑱ **Menu button [MENU]** -16-
- ⑲ **Joystick** -14-
- ⑳ **Mode dial** -14-
- ㉑ **Light button [LIGHT] (NV-GS37 only)** -20-
- ㉒ **Recording start/stop button** -22-

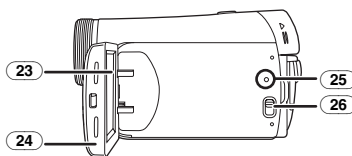

- ⑳ **LCD monitor** -11-, -48-

Due to limitations in LCD production technology, there may be some tiny bright or dark spots on the LCD monitor screen. However, this is not a malfunction and does not affect the recorded picture.

- ㉓ **LCD monitor open part [OPEN]** -11-
- ㉔ **Reset button [RESET]** -40-, -44-
- ㉕ **Mode select switch [AUTO/MANUAL/ FOCUS]** -21-, -27-, -30-

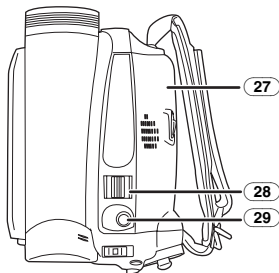

- 27 Cassette cover -13-
- 28 Zoom lever [W/T] -24-
Volume lever [-VOLUME+] -31-
- 29 Photoshot button [PHOTO SHOT] -23-

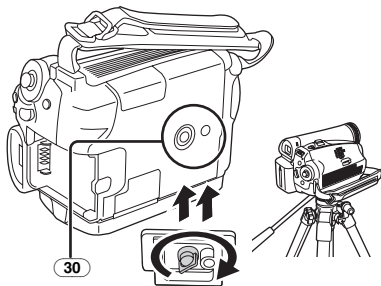

- 30 Tripod receptacle
This is a hole for attaching the camera to optional tripod/VW-CT45E. (Please carefully read the operating instructions for how to attach the tripod to the camera.)

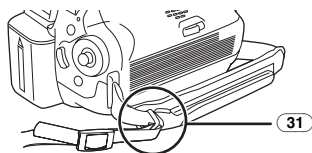

- 31 Shoulder strap fixture

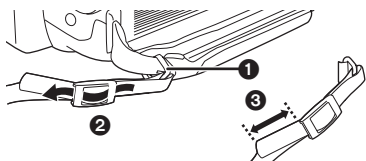

- Put the strap (optional) through the fixture ① and through the stopper ② so it will not come off. Extend part ③ by at least 2 cm.
- Fit the other end of the belt similarly.

Fitting the lens cap

Fit the lens cap to protect the surface of the lens.

- 1 The lens cap and lens cap cord comes preattached to the grip belt.
Pass the end of the lens cap cord through the attached eye on the lens cap. Then pass the lens cap through the loop made by itself and pull tight.

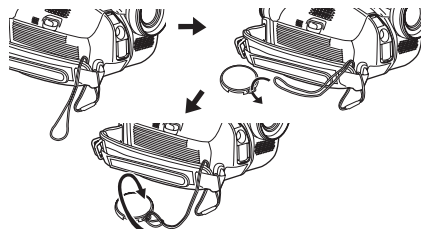

- When not using the lens cap, pull the lens cap cord in the direction of the arrow. ①
- When you are not recording, be sure to cover the lens with the lens cap for protection. ②

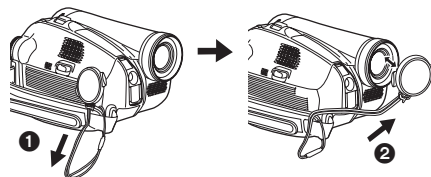

- When you remove the lens cap, press the knobs firmly.



The grip belt

Adjust the belt length so it fits your hand.

- 1 Adjust the belt length.

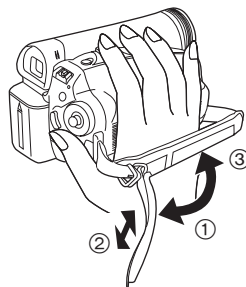

- ① Flip the belt.
- ② Adjust the length.
- ③ Fix the belt.

Power supply

■ Charging the battery

When this product is purchased, the battery is not charged. Charge the battery before using this product.

- Battery charging time (-9-)
- We recommend using Panasonic batteries.
- If you use other batteries, we cannot guarantee the quality of this product.
- If the DC input lead is connected to the AC adaptor, then the battery will not get charged. Remove the DC input lead from the AC adaptor.

- 1 Connect the AC mains lead to the AC adaptor and the AC mains socket.**
- 2 Put the battery on the battery mount by aligning the mark, and then securely plug it in.**

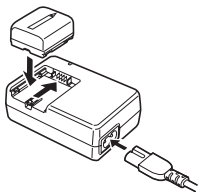

■ Charging lamp

Lights up: Charging

Goes off: Charging completed

Flashing: The battery is over discharged (discharged excessively). In a while, the lamp will light up and normal charging will start. When the battery temperature is excessively high or low, the [CHARGE] lamp flashes and the charging time will be longer than normal.

■ Connecting to the AC outlet

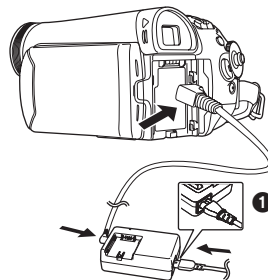

- 1 Connect the AC mains lead to the AC adaptor and the AC mains socket.**
- 2 Connect the DC input lead to the AC adaptor.**
- 3 Connect the DC input lead to this product.**
 - The output plug of the AC mains lead is not completely connected to the AC adaptor socket. As shown in ❶, there is a gap.
 - Do not use the power cord for other equipment since the power cord is exclusively designed for the movie camera. Or do not use the power cord of other equipment for the movie camera.

■ Fitting the battery

Push the battery against the battery holder and slide it until it clicks.

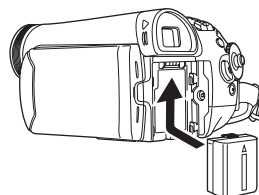

■ Removing the battery

While sliding the [BATTERY RELEASE] lever, slide the battery to remove it.

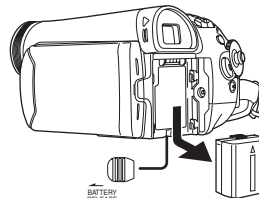

- Hold the battery with your hand so it does not fall.
- Before removing the battery, be sure to set the [OFF/ON] switch to [OFF].

Charging time and recordable time

The times shown in the table below show the times at a temperature of 25 °C and a humidity of 60%. This is just a guide. If the temperature is higher or lower than the specified value, the charging time will become longer.

Supplied battery/ CGR-DU06 (7.2 V/ 640 mAh)	(A)	1 h 40 min
	(B)	1 h 50 min (1 h 25 min)
	(C)	55 min (45 min)
CGA-DU12 (7.2 V/ 1150 mAh)	(A)	2 h 25 min
	(B)	3 h 15 min (2 h 40 min)
	(C)	1 h 40 min (1 h 20 min)
CGA-DU14 (7.2 V/ 1360 mAh)	(A)	2 h 45 min
	(B)	3 h 50 min (3 h)
	(C)	1 h 55 min (1 h 30 min)
CGA-DU21 (7.2 V/ 2040 mAh)	(A)	3 h 55 min
	(B)	5 h 45 min (4 h 30 min)
	(C)	2 h 55 min (2 h 15 min)
CGA-DU07 (7.2 V/ 680 mAh)	(A)	1 h 30 min
	(B)	1 h 55 min (1 h 30 min)
	(C)	1 h (45 min)







- (A) Charging time
- (B) Maximum continuously recordable time
- (C) Intermittent recordable time

(The intermittent recordable time refers to recordable time when the recording and stopping operations are repeated.)

"1 h 40 min" indicates 1 hour 40 minutes.

- The battery CGR-DU06 is supplied.
- The times shown in the table are rough estimates. The times indicate the recordable times when the viewfinder is used. The times in parentheses indicate the recordable times when the LCD monitor is used.
- We recommend the Battery Pack CGA-DU12, CGA-DU14 and CGA-DU21 for long time recording (2 hours or more for continuous recording, 1 hour or more for intermittent recording).

- The recordable time will become shorter in the following cases:

- When you use both the viewfinder and the LCD monitor simultaneously while rotating the LCD monitor frontward to record yourself etc.
- The batteries heat up after use or charging. The main unit of the movie camera being used will also heat up. This is normal.
- Along with the reduction of the battery capacity, the display will change:  →  →  →  → . If the battery discharges, then  () will flash.

Turning the camera on

When the camera is turned on with the lens cap fitted, the automatic white balance adjustment may not function properly. Please turn the camera on after removing the lens cap.

How to turn on the power

- 1 While pressing the button , set the [OFF/ON] switch to [ON].

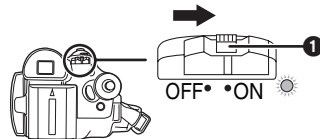

- The status indicator lights red and the power turns on.
- If the LCD monitor is closed and the viewfinder is retracted while the [OFF/ON] switch is set to [ON] in the Tape Recording Mode, the power turn off.

How to turn off the power

- 1 While pressing the button , set the [OFF/ON] switch to [OFF].

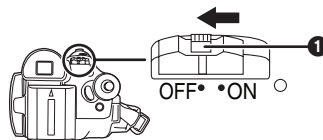

- Set the [OFF/ON] switch to [OFF] when not using the camera.
- The status indicator goes off when the power turns off.

■ How to turn the power on and off with the LCD monitor/viewfinder

When the power switch is set to [ON], the power can be turned on and off with the LCD monitor and the viewfinder when the unit is in Tape Recording Mode.

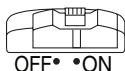

1 Open the LCD monitor out or extend the viewfinder to use. (-11-)

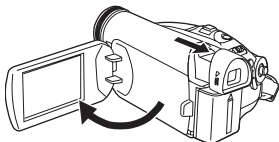

- The LCD monitor or the viewfinder will be activated.

2 Close the LCD monitor and retract the viewfinder.

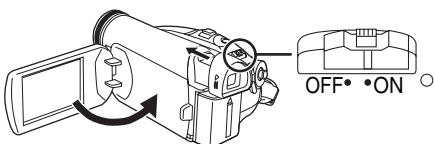

- The power will not turn off unless the LCD monitor is closed and the viewfinder is retracted.
- The status indicator automatically goes off and the power turns off. (If quick start is set to [ON] (-12-), the unit goes into quick start standby mode and the status indicator lights green.)
- The power does not turn off even if the LCD monitor is closed and the viewfinder is retracted while recording on a tape.

3 Open the LCD monitor or extend the viewfinder to turn the power on and use the movie camera again.



- The status indicator lights up and the power turns on.

Setting date and time

When the movie camera is turned on for the first time, [SET DATE AND TIME] will appear.



- Select [YES] and press the centre of the joystick. Do steps 2 and 3 below to set the date/time.

If the screen shows the incorrect date/time, then adjust it.

• Set to Tape Recording Mode.

1 Set [BASIC] >> [CLOCK SET] >> [YES]. (-16-)



2 Move the joystick left or right in order to select the item to be set. Then move the joystick up or down to set the desired value.

- The year will change as follows:
2000, 2001, ..., 2089, 2000, ...
- The 24-hour clock is used.

3 Press the joystick to determine the setting.

- The clock function starts at [00] seconds.

■ About date/time

- The date and time function are driven by a built-in lithium battery.
- Make sure to check the time before recording because the built-in clock is not very accurate.

■ Recharging the built-in lithium battery

- If [⊕] or [-] is appears when the camera is turned on, then the built-in lithium battery has run down. Use the steps below to charge the battery. When turn on the power for the first time after charging, [SET DATE AND TIME] will appear. Select [YES] and set the date and time. Connect the AC adaptor to the camera or attach the battery to the camera, and the built-in lithium battery will be recharged. Leave the camera as is for approx. 24 hours, and the battery will drive the date and time for approx. 6 months. (Even if the [OFF/ON] switch is set to [OFF], the battery is still being recharged.)

WARNING

THE LITHIUM BATTERY IN THIS EQUIPMENT MUST ONLY BE REPLACED BY QUALIFIED PERSONNEL. WHEN NECESSARY, CONTACT YOUR LOCAL PANASONIC SUPPLIER.

Using the LCD monitor

You can record the image while viewing it on the opened LCD monitor.

- 1 Put a finger on the LCD monitor open part and open the LCD monitor out in the direction of the arrow.

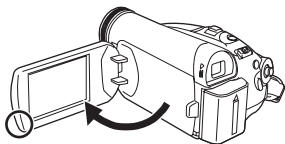

- It can open up to 90°.

- 2 Adjust the angle of the LCD monitor as you prefer.

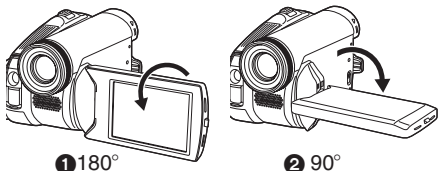

1 180°

2 90°

- It can rotate up to 180° 1 towards the lens or 90° 2 towards the viewfinder.

- The brightness and colour level of the LCD monitor can be adjusted from the menu.
- If it is forcibly opened or rotated, the camera may be damaged or fail.
- If the LCD monitor is rotated by 180° towards the lens and the viewfinder is extended (when recording yourself), the LCD monitor and the viewfinder simultaneously light.

Using the viewfinder**Extending the viewfinder**

- 1 Pull out the viewfinder. Extend it by pinching the extension knob.

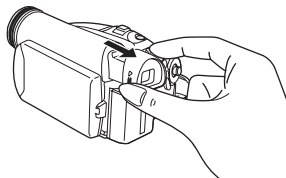

- The viewfinder will be activated. (If the LCD monitor is opened, the viewfinder will be deactivated.)

Adjusting the field of view

- 1 Adjust the focus by sliding the eyepiece corrector knob.



- You can adjust the brightness of the viewfinder from the menu.

Quick start

When quick start is on the battery power is still being consumed, even when the LCD monitor and the viewfinder are closed.

The camera will resume recording/pause mode about 1.7 seconds after the LCD monitor or the viewfinder is reopened.

- Please note in quick start mode approximately half the pause recording power is being consumed. Using quick start mode will reduce the battery recording/playback time.
- This is only activated in the following cases.
 - A tape is inserted, while the Tape Recording Mode is set.

• Set to Tape Recording Mode.

- 1 Set [SETUP] >> [QUICK START] >> [ON].
(-16-)



- 2 While the [OFF/ON] switch is still set to [ON], close the LCD monitor and retract the viewfinder.

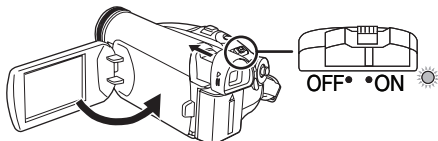

- The status indicator lights green and the unit goes into quick start standby mode.
- The movie camera will not go into quick start standby unless the LCD monitor is closed and the viewfinder is retracted.

- 3 Open the LCD monitor or extend the viewfinder.

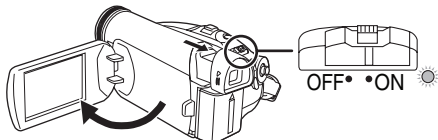

- The status indicator lights red and the camera is put into recording pause approx. 1.7 seconds after it is turned on.

■ To cancel Quick Start

- 1 Set [SETUP] >> [QUICK START] >> [OFF].
(-16-)

- If the [OFF/ON] switch is set to [OFF] while the unit is in quick start standby, the power turns off.
- If the standby continues for approx. 30 minutes, then the status indicator will go off and the camera will be completely turned off.

- If the Mode dial is moved or the battery is removed in quick start standby mode, quick start is cancelled and the power turns off.
- When the camera is quick-started with the white balance on automatic, it may take some time until the white balance is adjusted if the scene being recorded has a light source different from the scene last recorded. (When the colour night view function is used, however, the white balance of the scene last recorded is retained.)
- If the power is turned on in quick start standby, the zoom magnification becomes 5× and the picture size may differ from what it was before quick start standby.
- If [POWER SAVE] (-38-) is set to [5 MINUTES] and the unit automatically goes into quick start standby mode, set the [OFF/ON] switch to [OFF], then to [ON] again. Also, close the LCD monitor and retract the viewfinder and then open the LCD monitor or extend the viewfinder again.
- When using the AC adaptor, quick start can be used even if a tape is not inserted.

Inserting/removing a cassette

- 1 Fit the AC adaptor or the battery and turn on the power.
- 2 Slide the [OPEN/EJECT] lever and open the cassette cover.

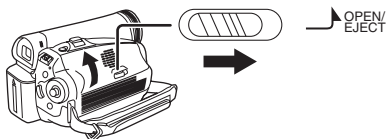

- When the cover is fully opened, the cassette holder will come out.

- 3 After the cassette holder is opened, insert/remove the cassette.

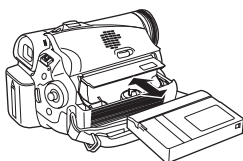

- When inserting a cassette, orient it as shown in the figure, and then securely insert it as far as it goes.
- When removing, pull it straight out.

- 4 Push the [PUSH] mark ① in order to close the cassette holder.

- The cassette holder is housed.

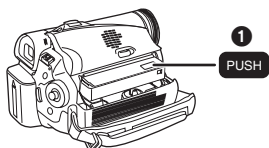

Caution:

Take care not to trap your fingers under the cassette holder when closing it.

- 5 Only after the cassette holder is completely housed, close the cassette cover by pressing the mark ②.

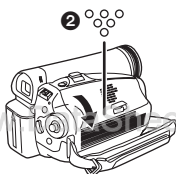

www.bonit4U.com

- When inserting a previously recorded cassette, use the blank search function to find the position where you want to continue recording. If you are overwriting a previously recorded cassette, be sure to find the position where you want to continue recording.
- Close the cassette cover tightly.
- When closing the cassette cover, do not get anything, such as a cable, caught in the cover.
- After use, be sure to rewind the cassette completely, remove it and put it in a case. Store the case in an upright position. (-47-)
- If the indicator of the condensation does not display on the LCD monitor and/or the viewfinder and you notice condensation on the lens or the main unit, do not open the cassette cover otherwise condensation may be formed on the heads or the cassette tape. (-45-)

■ When the cassette holder does not come out

- Close the cassette cover completely, and then open it again completely.
- Check if the battery has run down.
- Check if the cassette compartment cover is in contact with grip belt as shown below. If so, be sure the grip belt stays clear of the cover when opening.

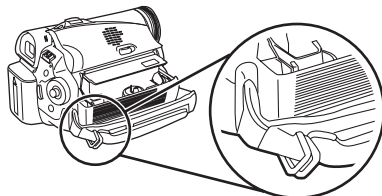

■ When the cassette holder cannot be housed

- Set the [OFF/ON] switch to [OFF], then to [ON] again.
- Check if the battery has run down.

■ Accidental erasure prevention

If the accidental erasure prevention slider ① of a cassette is opened (slide in the direction of the [SAVE] arrow), the cassette cannot be recorded. When recording, close the accidental erasure prevention slider of the cassette (slide in the direction of the [REC] arrow).

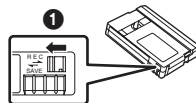

Selecting a mode

Rotate the mode dial to select the desired mode.

1 Rotate the mode dial.

- Set your desired mode to ❶.

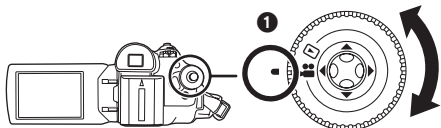

❶ : TAPE RECORDING MODE

Use this when you record the image on a tape.

▶ : TAPE PLAYBACK MODE

Use this to play back a tape.

How to use the joystick

Basic joystick operations

Operations on the menu screen and selection of files to be played back on the multi-image display

Move the joystick up, down, left or right to select an item or file, and then push in the centre to set it.

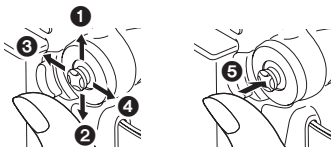

❶	Select by moving up.
❷	Select by moving down.
❸	Select by moving left.
❹	Select by moving right.
❺	Determine by pushing the centre.

Joystick and screen display

Push the centre of the joystick, and icons will be displayed on the screen. Each time the joystick is moved down, the indication changes.

(In the Tape Playback Mode, the icons will be automatically displayed on the screen.)

1) Tape Recording Mode

([AUTO/MANUAL/FOCUS] switch is set to [AUTO])

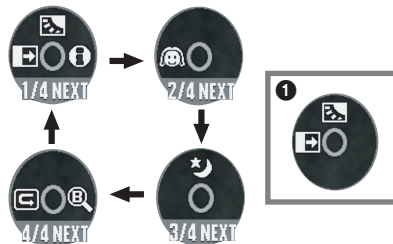

1/4	◀	📺	Fade	-26-
	▲	📺	Backlight compensation	-25-
	▶	📺	Help mode	-15-
2/4	◀	😊	Soft skin mode	-25-
3/4	▲	🌙	Colour night view	-25-
4/4	◀	📺	Recording check	-22-
	▶	🔍	Blank search	-23-

- ❶ is displayed while recording on a tape.

2) **Tape Recording Mode**
 ([AUTO/MANUAL/FOCUS] switch is set to [MANUAL])

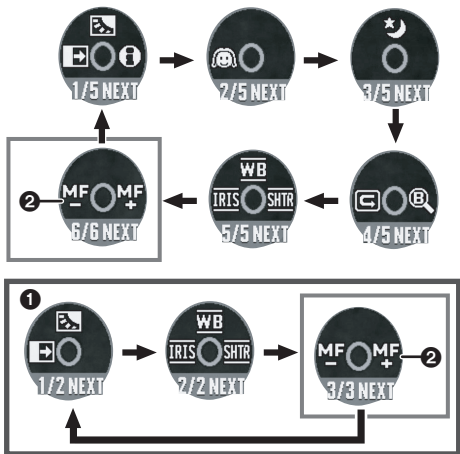

5/5	◀	IRIS	Iris or gain value	-30-
	▲	WB	White balance	-28-
	▶	SHTR	Shutter speed	-30-
6/6	◀	MF	Manual focus adjustment (When set to [FOCUS])	-29-
	▶	MF		

- 1 is displayed while recording on a tape.
- 2 is displayed only when the [AUTO/MANUAL/FOCUS] switch is set to [FOCUS].

3) **Tape Playback Mode**



	▲	⏸	Playback/pause	-31-
	▼	■	Stop	-31-
	◀	◀◀	Rewind (review playback)	-31-
	▶	▶▶	Fast forward (cue playback)	-31-

Help mode

Select an icon for an explanation of the function.

● **Set to Tape Recording Mode.**

- 1 Press the joystick to display the icon during the recording pause. Move the joystick down until icon 1 appears.



- 2 Move the joystick right to select the Help mode icon [1].



- The help mode explains the operation icons displayed when the [AUTO/MANUAL/FOCUS] switch is set to [AUTO] in Tape Recording Mode.

- 3 Move the joystick up, left, or right to select the desired icon.



- An explanation of the selected icon is displayed on the screen.
- Each time the joystick is moved down, the indication changes.

■ **To exit the Help mode**

Select [EXIT] or press the [MENU] button.

- When the Help mode is used, functions cannot be set.

Switching the language

You can switch the language on the screen display or the menu screen.

1 Set [LANGUAGE] >> select the desired language.



Using the menu screen

For each individual menu, please refer to -37-.

1 Press the [MENU] button.



- The menu corresponding to the mode selected by the mode dial is displayed.
- Do not switch the mode dial when the menu is displayed.

2 Move the joystick up or down in order to select the top menu.



3 Move the joystick right or press it to set the selection.



4 Move the joystick up or down in order to select the sub-menu.

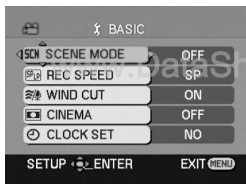

5 Move the joystick right or press it to set the selection.



6 Move the joystick up or down in order to select the item to be set.



7 Press the joystick to determine the setting.



■ To exit the menu screen

Press the [MENU] button.

■ To get back to the previous screen

Move the joystick left.



■ About the menu setting

- The menu is not displayed while recording on a tape. Also, you cannot record on a tape while the menu is displayed.

■ Operating with remote control (NV-GS37 only)

The menu screen transition is the same as when the buttons on the main unit are used.

1 Press the [MENU] button.

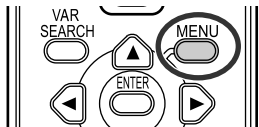

2 Select a menu item.

- Use the direction buttons (▲, ◀, ▶, ▼) and [ENTER] button in place of the joystick on the main unit.

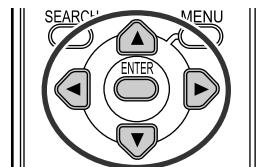

3 Press the [MENU] button to exit the menu screen.

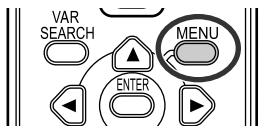

Adjusting LCD monitor/viewfinder

■ Adjusting the brightness and colour level

1 Set [SETUP] >> [LCD SET] or [EVF SET] >> [YES].

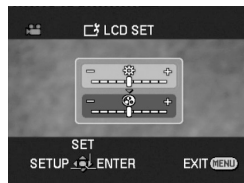

2 Move the joystick up or down in order to select the item to be adjusted.

[LCD SET]

- ☀ : Brightness of the LCD monitor
- 🌈 : Colour level of the LCD monitor

[EVF SET]

EVF☀ : Brightness of the viewfinder

- 3 Move the joystick left or right to move the bar indication representing the brightness.
- 4 Press the [MENU] button or the joystick to complete the settings.

- When the LCD monitor is rotated by 180° towards the lens, the brightness of the LCD monitor cannot be adjusted.
- To adjust the brightness of the viewfinder, close the LCD monitor and extend the viewfinder to activate it.
- These settings will not affect the images actually recorded.
- If you adjust the colour level of the LCD monitor, the colour level of the viewfinder also automatically changes. (NV-GS37 only)

Using the remote control

(NV-GS37 only)

Remote control

Using the remote control supplied will enable controlling almost all the functions of this camera to be controlled.

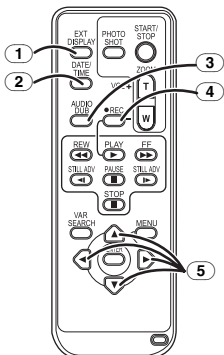

- ① On-screen display button [EXT DISPLAY] -33-
- ② Date/time button [DATE/TIME] -37-
- ③ Audio dubbing button [AUDIO DUB] -35-
- ④ Record button [●REC] (not operable)
- ⑤ Direction buttons [▲, ◀, ▶, ▼] -17-

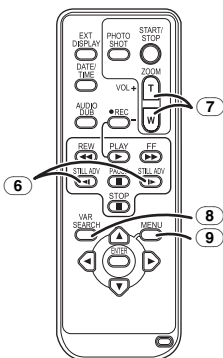

- ⑥ Slow/frame-by-frame forward button [◀, ▶] (◀: reverse, ▶: forward) -32-
- ⑦ Zoom/volume button [ZOOM/VOL] *
- ⑧ Search button [VAR SEARCH] -32-
- ⑨ Menu button [MENU] * -17-

www.DataSheet4U.com

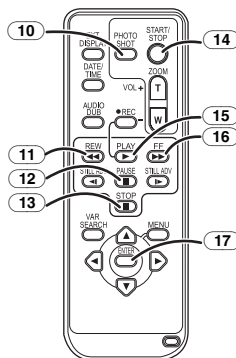

- ⑩ Photoshot button [PHOTO SHOT] *
- ⑪ Rewind/review button [◀◀]
- ⑫ Pause button [||]
- ⑬ Stop button [■]
- ⑭ Recording start/stop button [START/STOP] *
- ⑮ Playback button [▶▶]
- ⑯ Fast forward/cue button [▶▶▶]
- ⑰ Enter button [ENTER] -17-

* means that these buttons function in the same manner as the corresponding buttons on the movie camera.

Install a button-type battery

Install the button-type battery supplied in the remote control before using it.

- 1 While pressing the stopper ①, pull out the battery holder.

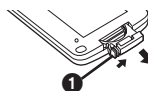

- 2 Set the button-type battery with its (+) mark facing upward and get the battery holder back in place.

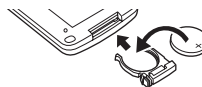

WARNING

“THE LITHIUM BATTERY IS A CRITICAL COMPONENT (TYPE NUMBER CR2025 MANUFACTURED BY PANASONIC). IT MUST NEVER BE SUBJECTED TO EXCESSIVE HEAT OR DISCHARGE. IT MUST THEREFORE ONLY BE FITTED IN EQUIPMENT DESIGNED SPECIFICALLY FOR ITS USE.

REPLACEMENT BATTERIES MUST BE OF THE SAME TYPE AND MANUFACTURER. THEY MUST BE FITTED IN THE SAME MANNER AND LOCATION AS THE ORIGINAL BATTERY, WITH THE CORRECT POLARITY CONNECTIONS OBSERVED.

DO NOT ATTEMPT TO RE-CHARGE THE OLD BATTERY OR RE-USE IT FOR ANY OTHER PURPOSE. IT SHOULD BE DISPOSED OF IN WASTE PRODUCTS DESTINED FOR BURIAL RATHER THAN INCINERATION.”

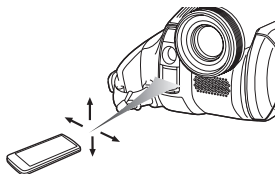
Remote control usable range

- The distance between the remote control and the camera: Within approx. 5 m
Angle: Approx. 15° up, down, left, and right

Selecting the remote control mode

If 2 cameras are used simultaneously, set the mode for one pair of movie camera and remote control to [VCR1] and that of the other pair to [VCR2]. This will prevent interference between the 2 pairs. (The default setting is [VCR1]. When the button-type battery is replaced, the setting will revert to the default [VCR1].)

1 Setting on the camera:

Set [SETUP] >> [REMOTE] >> [VCR1] or [VCR2].

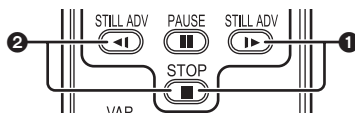
2 Setting on the remote control:

[VCR1]:

Press [▶] and [■] simultaneously. **1**

[VCR2]:

Press [◀] and [■] simultaneously. **2**

Concerning the button-type battery

- When the button-type battery runs down, replace it with a new battery (part number: CR2025). The battery is normally expected to last about 1 year, but it depends on operation frequency.
 - Keep the button-type battery out of the reach of children.
-
- If the remote control mode of the camera and that of the remote control do not match with each other, “REMOTE” will appear. When the remote control is operated for the first time after the camera is turned on, “CHECK REMOTE MODE” (-40-) will appear and operation is impossible. Set the same remote control mode.
 - The remote control is intended for indoor operation. Outdoors or under strong light, the movie camera may not operate properly even within the usable ranges.

Recording with the built-in LED video light (NV-GS37 only)

Gain up mode works with the built-in LED video light to enhance the light's brightness and brighten the natural colours in a scene.

1 Press the [LIGHT] button. ①



- The built-in LED video light lights up and the gain up mode is set to on.
- The gain up mode will be brighter than when only the LED video light is on, but washed out images will appear.

2 Press the [LIGHT] button. ②

- The gain up mode is set to off.
- To eliminate washed out images, use this mode.

3 Press the [LIGHT] button. ③

- The LED video light turns off.
- Pressing the [LIGHT] button again returns to ①.

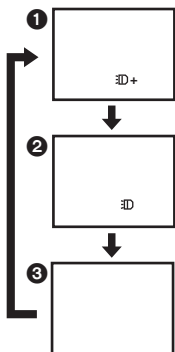

- The subject should be within 1.5 metres of the movie camera.
- Using the LED video light reduces battery time.
- Set the LED video light to off when not in use.
- Do not look directly into the light.
- If the LED video light is used with a conversion lens attached, a slight vignetting (darkening around edges) effect occurs on the screen.
- Using the colour night view function at the same time will make conditions even brighter.
- The LED video light enables simply lightening the images taken in a dimly-lit place. We also recommend using it in a bright place to obtain high quality images.

Record mode

Check before recording

Check the following before recording important events such as weddings or when the movie camera has not been used for a long time. Conduct a test recording to make sure that the image recording and the audio recording work properly.

Basic camera holding

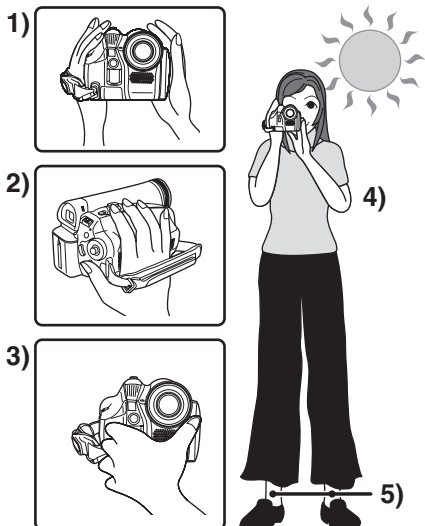

- 1) Hold the camera with both hands.
- 2) Run your hand through the grip belt.
- 3) Do not cover the microphones or sensors with your hands.
- 4) Keep your arms near your body.
- 5) Slightly open your legs.

• When you are in the open air, record pictures with the sunlight as far in the background as possible. If the subject is backlit, it will become dark in the recording.

Check points

- Remove the lens cap. (-7-)
(When the camera is turned on with the lens cap fitted, the automatic white balance adjustment may not function properly. Please turn the camera on after removing the lens cap.)
- Grip belt adjustment (-7-)
- Open the LCD monitor or extend the viewfinder (Recording cannot start while the LCD monitor and the viewfinder are closed. Even if the LCD monitor and the viewfinder are closed during recording, the power will not turn off until recording stops.)

- Adjustment of LCD monitor/viewfinder (-17-)
- Power supply (-8-)
- Insert a cassette (-13-)
- Setting date/time (-10-)
- Getting the remote control ready (NV-GS37 only) (-18-)
- Setting SP/LP mode (-21-)

About auto mode

- Set the [AUTO/MANUAL/FOCUS] switch to [AUTO], and colour balance (white balance) and focusing will be adjusted automatically.
 - Auto white balance: -49-
 - Auto focusing: -49-
- Depending on the brightness of the subject etc., the aperture and shutter speed are automatically adjusted for an optimum brightness. (When set to the Tape recording mode: The shutter speed is adjusted to a maximum of 1/250.)
- Colour balance and focus may not be adjusted depending on light sources or scenes. If so, manually adjust the white balance and focus.

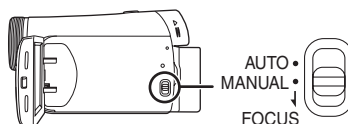

- Scene mode setting (-27-)
- White balance setting (-28-)
- Shutter speed setting (-30-)
- Iris/gain value setting (-30-)
- Focus setting (-29-)

Recording mode

You can switch the tape recording mode.

Set to Tape Recording Mode.

1 Set [BASIC] >> [REC SPEED] >> [SP] or [LP].

If the LP mode is selected, the recording time will be 1.5 times the SP mode, but some functions will be disabled.

- We recommend using the SP mode for important recording.
- In order to fully exhibit the performances of the LP mode, we recommend using Panasonic cassettes marked LP mode.
- It is not possible to dub audio onto image recorded in the LP mode. (-35-)
- In the LP mode, the picture quality will not be degraded in comparison with the SP mode, but mosaic noise may appear on the playback image or some functions may be disabled.
 - Playback on other digital video equipment or on digital video equipment without the LP mode.

- Playback of the image on other digital video equipment recorded in the LP mode.
- Slow/frame-by-frame playback.

Recording on a tape

Remove the lens cap. (-7-)
 (When the camera is turned on with the lens cap fitted, the automatic white balance adjustment may not function properly. Please turn the camera on after removing the lens cap.)

● **Set to Tape Recording Mode.**

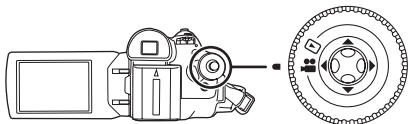

1 Press the recording start/stop button to start recording.

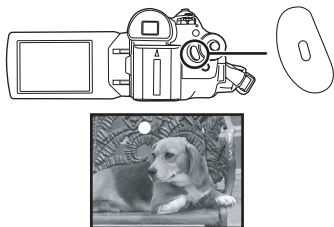

2 Press the recording start/stop button again to pause recording.



- For the recording time on a tape, refer to -9-.
- Carry out a recording check (-22-) to verify that the image is recorded properly.
- In order to find the unrecorded section, carry out the blank search (-23-).
- If you want to preserve the original sound recorded when audio dubbing (-35-), set [ADVANCED] >> [AUDIO REC] >> [12bit] to take pictures.

On-screen display in the tape recording mode

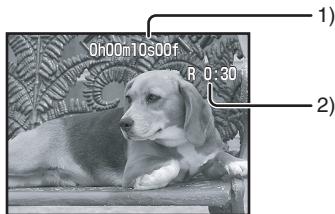

- 1) Recording time elapse
- 2) Remaining tape indication

Concerning the remaining tape time indication on the screen

- The remaining tape time is indicated in minutes. (When it reaches less than 3 minutes, the indication starts flashing.)
- During a 15 seconds or shorter recording, the remaining tape time indication may not be displayed or the remaining tape time may not be displayed correctly.
- In some cases, the remaining tape time indication may display remaining tape time that is 2 to 3 minutes shorter than the actual remaining tape time.

Recording check

The last image recorded is played back for 2 to 3 seconds. After checking, the camera will be set to a recording pause.

● **Set to Tape Recording Mode.**

- 1 Press the joystick to display the icon during the recording pause. Move the joystick down until icon 1 appears.**
- 2 Move the joystick left to select the recording check icon [RECORDING CHECK STARTED].**



- The [RECORDING CHECK STARTED] indication appears on the screen of the movie camera.

Blank search function

Searches for the last part of the image recorded (unused part of the tape). After the search is finished, the blank search function is cancelled and the camera is put into recording pause.

● Set to Tape Recording Mode.

- 1 Press the joystick to display the icon during the recording pause. Move the joystick down until icon ❶ appears.
- 2 Move the joystick right to select the blank search icon [Ⓚ].



- 3 When the confirmation message appears, select [YES] and press the centre of the joystick.

■ Stopping blank search midway through

Move the joystick down to select the [■] icon.



- If the cassette tape has no blank part, then the camera will stop at the end of the tape.
- The camera stops at a point approx. 1 second before the end of the last image recorded. When you start recording at that point, the image can be recorded seamlessly from the last image.

Recording a still picture on a tape (Photoshot)

Still pictures can be recorded from the movie camera lens.

● Set to Tape Recording Mode.

- 1 Press the [PHOTO SHOT] button in the recording pause mode.

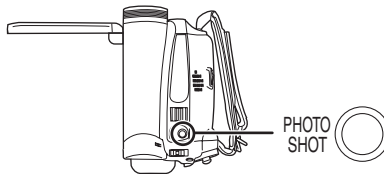

- The movie camera records a still picture for about 7 seconds and then switches back to the recording pause mode.
- If you set [ADVANCED] >> [SHTR EFFECT] >> [ON], you can add image and a sound like releasing the shutter.

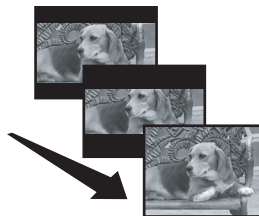

- Photoshot recording results in slightly inferior image quality.

■ Continuous photoshot

If you set [ADVANCED] >> [SHTR EFFECT] >> [ON] and keep the [PHOTO SHOT] button pressed, the movie camera will continuously record still pictures in approx. 0.7 seconds intervals until the button is released.

- The screen blinks and, at the same time, a shutter clicking sound is recorded.

Zoom in/out function

You can zoom in up to 30× optically.

● Set to Tape Recording Mode.

1 Wide-angle recording (zoom out):

Push the [W/T] lever towards [W].

Close-up recording (zoom in):

Push the [W/T] lever towards [T].

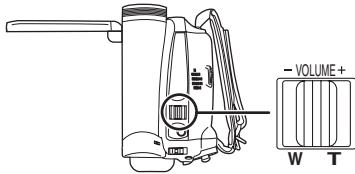

- When zooming in and taking a picture while holding the movie camera by hand, we recommend using the image stabilizer function.
- When you are zooming on a faraway subject, a sharper focus is achieved if the recording subject is 1.3 metres or further from the movie camera.
- When the zoom speed is high, the subject may not be focused easily.
- When the zoom magnification is 1×, the movie camera can focus on a subject approx. 2 cm distant from the lens.

■ Digital zoom function

If the zoom magnification exceeds 30 times, then the digital zoom function will be activated. The digital zoom function allows you to select a magnification from 50× to 1000×.

1 Set [ADVANCED] >> [D.ZOOM] >> [50×] or [1000×].



[OFF]: Optical zoom only (Up to 30×)

[50×]: Up to 50×

[1000×]: Up to 1000×

- The larger the digital zoom magnification, the more the image quality is degraded.

■ About the variable speed zoom function

- When pushing the [W/T] lever as far as it will go, you can zoom from 1× to 30× in 3.5 seconds at the maximum.
- The zoom speed varies according to the amount of movement of the [W/T] lever.
- The variable speed zoom function cannot be used with the remote control. (NV-GS37 only)

■ To use the zoom microphone function

Interlocked with the zooming operation, the microphone will collect sounds clearly far away with the tele-shot or those in the vicinity with the wide-angle shot.

● Set to Tape Recording Mode.

1 Set [ADVANCED] >> [ZOOM MIC] >> [ON].



Recording yourself

You can record yourself while viewing the LCD monitor. You can record persons in front of the camera while presenting them the image. The image is horizontally flipped as if you see a mirror image. (The image to be recorded is the same as that recording.)

● Extend the viewfinder to see the picture while recording.

1 Rotate the LCD monitor towards the lens side.

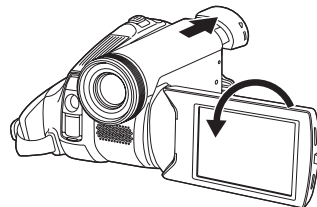

- A vertically oriented display appears on the viewfinder screen, this is normal and not indicative of any trouble.
- When the LCD monitor is rotated towards the lens side, the icon will not be displayed even if you push the centre of the joystick.

Backlight compensation function

This protects a backlit subject from being darkened.

● Set to Tape Recording Mode.

- 1 Press the joystick to display the icon. Move the joystick down until icon ❶ appears.
- 2 Move the joystick up to select the backlight compensation icon [☀️].



- The [BACKLIGHT COMPENSATION ON] indication appears on the screen of the movie camera.
- The image on the screen will become brighter.

■ To return to normal recording

Select the [☀️] icon again.

- The [BACKLIGHT COMPENSATION OFF] indication appears on the screen of the movie camera.

- If you turn off the power or operate the mode dial, the backlight compensation is cancelled.

Colour Night view function

This function allows you to record colour subjects in dark locations to stand out against the background.

Attach the camera to a tripod, and you can record images free from vibration.

- Only manual focusing can be used.
- Recorded scene is seen as if frames were missed.

Colour night view function

You can record dark locations brightly in colour.

● Set to Tape Recording Mode.

- 1 Press the joystick to display the icon. Move the joystick down until icon ❶ appears.
- 2 Move the joystick up to select the colour night view icon [🌃].



- The [COLOUR NIGHT VIEW ON] indication appears on the screen of the movie camera.
- Each upward press switches the modes.
OFF → Colour night view function → OFF

■ To cancel the colour night view function

Select the [🌃] icon again.

- The [COLOUR NIGHT VIEW OFF] indication appears on the screen of the movie camera.
- If set in a bright place, the screen may become whitish for a while.
- The colour night view function makes the signal charging time of CCD up to approximately 25× longer than usual, so that dark scenes invisible to the naked eye can be recorded brightly. For this reason, bright dots that are usually invisible may be seen, but this is not a malfunction.
- The colour night view function is cancelled when you turn off the power or operate the mode dial.

Soft skin mode

This allows the skin colour to be recorded in a softer tone. This is more effective if you record the bust image of a person.

● Set to Tape Recording Mode.

- 1 Press the joystick to display the icon. Move the joystick down until icon ❶ appears.
- 2 Move the joystick left to select the soft skin icon [😊].



- The [SOFT SKIN MODE ON] indication appears on the screen of the movie camera.

■ To cancel the soft skin mode

Select the [😊] icon again.

- The [SOFT SKIN MODE OFF] indication appears on the screen of the movie camera.

- If the background or anything else in the scene has colours similar to the skin colour, they will also be smoothed.
- If the brightness is insufficient, the effect may not be clear.

Fade in/fade out function

Fade in

The image and audio gradually appear.

Fade out

The image and audio gradually disappear.

●Set to Tape Recording Mode.

- 1 Press the joystick to display the icon. Move the joystick down until icon ❶ appears.
- 2 Move the joystick left to select the fade icon [❷].

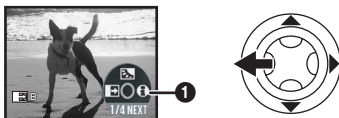

- The [FADE ON] indication appears on the screen of the movie camera.

3 Press the recording start/stop button. Start recording. (fade in)

When you start recording, the image/audio disappeared completely and the image/audio gradually appears.



Pause recording. (fade out)

The image/audio gradually disappears. After the image/audio completely disappears, recording stops.



■ To cancel fading

Select the [❷] icon again.

- The [FADE OFF] indication appears on the screen of the movie camera.

■ To select the colour for fade in/out

The colour which appears in fading pictures can be selected.

- 1 Set [ADVANCED] >> [FADE COLOUR] >> [WHITE] or [BLACK].

- While the fade in/fade out function is selected, it takes several seconds to display the image when you start recording images. Besides, it also takes several seconds to pause recording.

Wind noise reduction function

This reduces the wind noise coming into the microphone when recording.

●Set to Tape Recording Mode.

- 1 Set [BASIC] >> [WIND CUT] >> [ON].



■ To cancel the wind noise reduction function

Set [BASIC] >> [WIND CUT] >> [OFF].

- The default setting is [ON].
- Reduces the wind noise depending on the wind strength. (If this function is activated in strong winds, the stereo effect may be reduced. When the wind weakens, the stereo effect will be restored.)

Recording images for wide-screen TVs

This allows you to record images compatible with wide-screen TVs.

Cinema Function

Images are recorded with a black belt appearing along the top and bottom of the screen so that they look like theatre movies.

●Set to Tape Recording Mode.

- 1 Set [BASIC] >> [CINEMA] >> [ON].

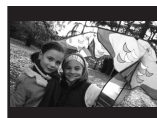

■ To cancel the Cinema function

Set [BASIC] >> [CINEMA] >> [OFF].

- Images played back vary depending on the TV connected. Please refer to the operating instructions for your TV.
- This function does not widen the recording range.
- When images are played back on a TV screen, the date/time indication may be erased in some cases.
- Depending on the TV, the picture quality may deteriorate.
- When a cinema picture is imported into a personal computer, the imported picture may not be displayed correctly, depending on the software in used.

Image stabilizer function

Reduces the image shaking due to hand movement when recording.

● Set to Tape Recording Mode.

1 Set [ADVANCED] >> [SIS] >> [ON].



■ To cancel the image stabilizer function

Set [ADVANCED] >> [SIS] >> [OFF].

- When a tripod is used, we recommend that you turn the image stabilizer off.
- Under fluorescent lighting, image brightness may change or colours may not look natural.
- When the colour night view function is used, the image stabilizer function does not work. If so, the [] indication flashes.
- In the following cases, the image stabilizer function may not work effectively.
 - When the digital zoom is used
 - When a conversion lens is used
 - When recording is done in an extremely dark place
 - When the camera is shaken greatly
 - When you record a moving subject while tracking it

Recording in various situations (Scene mode)

When you record images in different situations, this mode automatically sets optimum shutter speeds and apertures.

● Set to Tape Recording Mode.

1 Set the [AUTO/MANUAL/FOCUS] switch to [MANUAL].

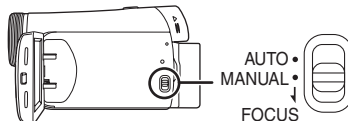

2 Set [BASIC] >> [SCENE MODE] >> select the desired mode.

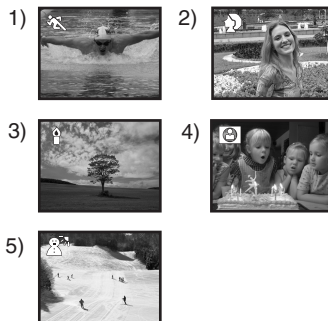

- 1) [] **Sports mode**
 - To record sports scenes or scenes where there are quick motions
- 2) [] **Portrait mode**
 - To make persons stand out against the background
- 3) [] **Low light mode**
 - To record dark scenes so they are brighter
- 4) [] **Spotlight mode**
 - To record subjects spotlighted in a party or theatre
- 5) [] **Surf & snow mode**
 - To record images at dazzling places such as ski slopes and beaches

■ To cancel the scene mode function

Set [BASIC] >> [SCENE MODE] >> [OFF] or set the [AUTO/MANUAL/FOCUS] switch to [AUTO].

Sports mode

- For slow-motion playback or playback pause of recorded pictures, this mode presents free of camera shakes.
- During normal playback, the image movement may not look smooth.
- Avoid recording under fluorescent light, mercury light or sodium light because the colour and brightness of the playback image may change.
- If you record a subject illuminated with strong light or a highly reflective subject, vertical lines of light may appear.
- If the brightness is insufficient, the sports mode does not function. The [] indication flashes.
- If this mode is used indoors, the screen may flicker.

Portrait mode

- If this mode is used indoors, the screen may flicker. If so, change the scene mode setting to [OFF].

Low light mode

- Extremely dark scenes may not be able to be recorded finely.

Spotlight mode

- If the recording subject is extremely bright, the recorded image may become whitish and the periphery of the recorded image extremely dark.

Surf & snow mode

- If the recording subject is extremely bright, the recorded image may become whitish.

Recording in natural colours (White balance)

The automatic white balance function may not reproduce natural colours depending on the scenes or lighting conditions. If so, you can adjust the white balance manually.

● Set to Tape Recording Mode.

1 Set the [AUTO/MANUAL/FOCUS] switch to [MANUAL].

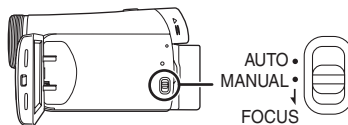

2 Move the joystick up to select the white balance icon [WB].



3 Move the joystick left or right in order to select the white balance mode.

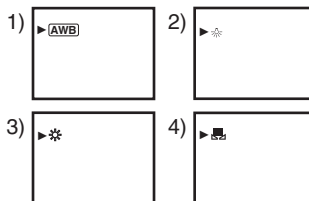

- 1) Auto white balance adjustment [AWB]
- 2) Indoor mode (for recording under incandescent lamps) []
- 3) Outdoor mode []
- 4) Manual adjustment mode []

■ To restore to the automatic adjustment

Move the joystick left or right until the [AWB] indication appears. Or, set the [AUTO/MANUAL/FOCUS] switch to [AUTO].

- When the camera is turned on with the lens cap fitted, the automatic white balance adjustment may not function properly. Please turn the camera on after removing the lens cap.
- When setting both the white balance and the iris/gain, set the white balance first.
- Whenever recording conditions change, re-set the white balance for correct adjustment.

■ To set the white balance manually

Select [] in Step 3. Then, while viewing a white subject on the entire screen, move the joystick up to select the [] indication.

■ About flashing of the [] indication When the manual adjustment mode is selected

- Flashing indicates that the white balance previously adjusted is stored. This setting is stored until the white balance is adjusted again.

When white balance cannot be set in the manual adjustment mode

- White balance may not be adjusted properly in the manual adjustment mode in dark places. If so, use the auto white balance mode.

During setting in the manual adjustment mode

- When the setting is completed, it will keep lit.

■ About the white balance sensor

The white balance sensor detects the type of light source during recording.

- Do not cover the white balance sensor during recording, or it may not function properly.

Manual focus adjustment

If auto focusing is difficult due to the conditions, then manual focusing is available.

● Set to Tape Recording Mode.

- 1 Set the [AUTO/MANUAL/FOCUS] switch to [MANUAL].

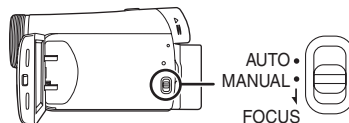

- 2 Set the [AUTO/MANUAL/FOCUS] switch to [FOCUS].

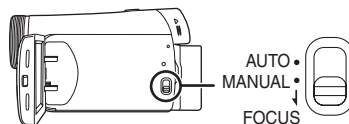

- The MNL and the manual focus indication [MF] will be displayed.

- 3 Move the joystick left or right in order to adjust the focus.



- When focused with a wide angle, the subject may not be in focus when zoomed in. First, zoom in on the subject, and then focus on it.

■ To restore to the automatic adjustment

Set the [AUTO/MANUAL/FOCUS] switch to [AUTO] or [FOCUS].

Manual shutter speed/aperture adjustment

Shutter Speed

Adjust it when recording fast-moving subjects.

Aperture

Adjust it when the screen is too bright or too dark.

● Set to Tape Recording Mode.

- 1 Set the [AUTO/MANUAL/FOCUS] switch to [MANUAL].



- 2 Move the joystick left or right to select the shutter aperture icon [IRIS] or shutter speed icon [SHTR].



- 3 Move the joystick left or right in order to adjust the shutter speed or aperture.

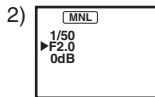

- 1) Shutter speed
- 2) (Aperture) Iris/gain value

■ To restore to automatic adjustment

Set the [AUTO/MANUAL/FOCUS] switch to [AUTO].

Manual shutter speed adjustment

- Avoid recording under fluorescent light, mercury light or sodium light because the colour and brightness of the playback image may change.
- If you increase the shutter speed manually, the sensitivity lowers and accordingly the gain value increases automatically, which may increase the noises on the screen.
- You may see vertical lines of light in the playback image of a brightly shining subject or highly reflective subject, but this is not a malfunction.
- During normal playback, image movement may not look smooth.
- When recording in the extremely bright place, the colour of the screen may change or flickers. If so, adjust the shutter speed manually to 1/50 or 1/100.

Manual iris/gain adjustment

- Set the shutter speed before setting the aperture (iris/gain) when manually adjusting both settings.
- If the value does not become "OPEN", you cannot adjust the gain value.
- If the gain value is increased, the noise on the screen increases.
- Depending on the zoom magnification, there are iris values that are not displayed.

■ Shutter speed range

1/50 to 1/8000 seconds: Tape Recording Mode
The shutter speed closer to 1/8000 is faster.

■ Iris/gain value range

CLOSE (Closed), F16, ..., F2.0,
OPEN (Opened: F1.8) 0dB, ..., 18dB
Value closer to [CLOSE] darken the image.
Value closer to [18dB] brighten the image.
Values with dB are gain values.

Playback mode

Playing back tape

- **Set to Tape Playback Mode.**
(An operation icon automatically appears on the LCD monitor.)

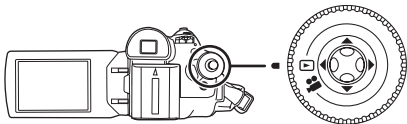

1 Operate with joystick.



- ▶/||: Playback/Pause
- ◀◀: Rewind/Review playback (Reverts to playback with the ▶/|| icon.)
- ▶▶: Fast forward/Cue playback (Reverts to playback with the ▶/|| icon.)
- : Stop

- The power will not turn off when the LCD monitor and the viewfinder are closed and retracted during Tape Playback Mode.
- During cue/review playback, fast-moving images may show noise as a mosaic.
- Before and after cue/review playback, the screen may become black for a moment or images may be disturbed.

■ To adjust volume

Adjust the speaker volume for playback.

- 1 Move the [–VOLUME+] lever to adjust the volume.

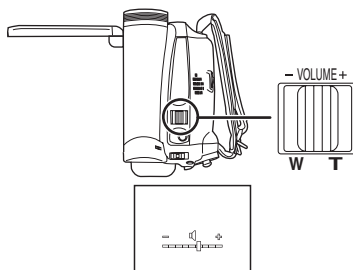

Towards [+]: increases the volume
Towards [–]: decreases the volume
(Nearer the bar to [+], larger the volume.)

- On the remote control, press the [T] button to increase the volume or the [W] button to decrease it. (NV-GS37 only)
-
- When the adjustment is completed, the volume indication will disappear.
 - If you do not hear the sound, check the settings of [SETUP] >> [12bit AUDIO].

■ Repeat playback

When the tape end is reached, the tape will be rewound and played back again.

- 1 Set [ADVANCED] >> [REPEAT PLAY] >> [ON].

- The [↺▶] indication appears. (In order to cancel the repeat playback mode, set [REPEAT PLAY] >> [OFF] or turn off the power.)
- When you set [USB FUNCTION] >> [WEBCAM] and then connect the USB connection cable, the repeat playback mode is cancelled. (NV-GS37 only)

■ Settings on the audio

- If you cannot listen to the desired audio when playing back a tape, check the settings in [SETUP] >> [12bit AUDIO].
- When you record or dub the audio in [12bit] and set [SETUP] >> [12bit AUDIO] >> [MIX], the audio will be played back in stereo sound regardless of the settings in [AUDIO OUT].

Slow-motion playback/ frame-by-frame playback

● Set to Tape Playback Mode.

(Slow-motion playback can only be performed by using the remote control.)

Slow-motion playback (NV-GS37 only)

If the image is recorded in the SP mode, then it will be played back at a speed approx. 1/5 the normal speed.

If the image is recorded in the LP mode, then it will be played back at a speed approx. 1/3 the normal speed.

1 Press the [◀] button or the [▶] button on the remote control.

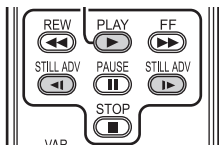

- If the slow-motion playback continues for approx. 10 minutes or more, then the playback will automatically stop. (10 minutes of slow-motion playback is equivalent to approx. 2 minutes in the SP mode or approx. 3 minutes in the LP mode.)

Frame-by-frame playback

1 During playback, press the [||] button on the remote control.

2 Press the [◀] button or the [▶] button on the remote control.

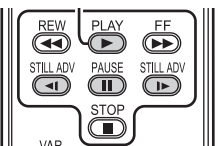

- Pushing the [-VOLUME+] lever towards [T] (normal direction) or towards [W] (reversed direction) of this camera during playback pause also turns into the frame-by-frame playback. If you keep pushing the lever, then the images will continuously be played back frame by frame.

■ To return to normal playback

Press the [PLAY ▶] button on the remote control or move the joystick up to the [▶] icon to start playback.

Slow-motion playback

- In the reversed slow-motion playback, the time code indication may be unstable.

Frame-by-frame playback

- Press and hold the [◀] or the [▶] button in the playback pause, and then the images will continuously be played back frame by frame.

Variable-speed search function (NV-GS37 only)

The speed of cue/review playback can be varied. (This operation is only available when using the remote control.)

- Set to Tape Playback Mode and play back a tape.

1 Press the [VAR SEARCH] button on the remote control.

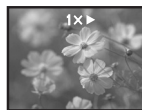

2 Press the [▲] or [▼] button to vary the speed.

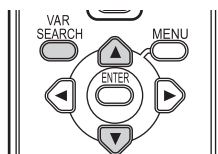

- The speeds for cue/review playback are 1/5× (SP mode slow-motion playback only), 1/3× (LP mode slow-motion playback only), 2×, 5×, 10×, 20×.

■ To return to normal playback

Press the [VAR SEARCH] button or [PLAY ▶] button on the remote control.

- Images may be shown in a mosaic-like pattern.
- The sound is muted during search.
- This function is cancelled when the operation icon is displayed.
- When you cue/review playback at 20×, the speed switches to 10× near the end of the tape. ([10×] flashes on the screen.)

Playback on TV

Images recorded by this camera can be played back on a TV.

- Insert a recorded tape into this camera.

1 Connect the movie camera and a TV.

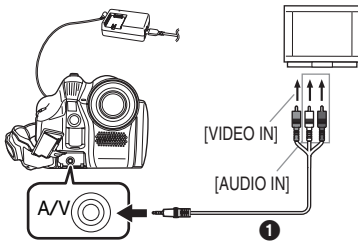

- Connect the movie camera and a TV by using the AV cable ①.
 - If your TV is not equipped with AV Input Sockets, the 21-pin Adaptor (purchase separately) is necessary. Consult your dealer.
- ### 2 Turn on this camera and set the mode dial to the Tape Playback Mode.
- ### 3 Select the input channel on the TV.
- ### 4 Move the joystick up to select the [▶/||] icon to start playback.
- The image and audio are output on the TV.
- ### 5 Move the joystick down to select the [■] icon to stop playback.

- Use the AC adaptor to free you from worrying about the battery running down.

■ If the image or audio from this camera is not output on the TV

- Check that the plugs are inserted as far as they go.
- Check the [12bit AUDIO] settings. (-35-)
- Check the connected terminal.
- Check the TV's input setting (input switch).
(For more information, please read the operating instructions for the TV.)

■ To display the on-screen information on the TV (NV-GS37 only)

The information displayed on the LCD monitor or the viewfinder (operation icon, time code and mode indication, etc.) can be displayed on the TV. (This operation is only available when using the remote control.)

- ### 1 Press the [EXT DISPLAY] button on the remote control.

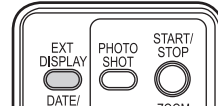

- Press the button again to erase the information.

Edit mode

Copying onto a DVD recorder or a VCR (Dubbing)

Pictures recorded by the movie camera can be stored on a DVD-RAM or other such media. Refer to the instructions for the recorder.

- Place a recorded cassette in the movie camera, and an unrecorded DVD-RAM or cassette in the DVD recorder or VCR.

1 Connect the movie camera and the recorder.

Connecting with the AV cable

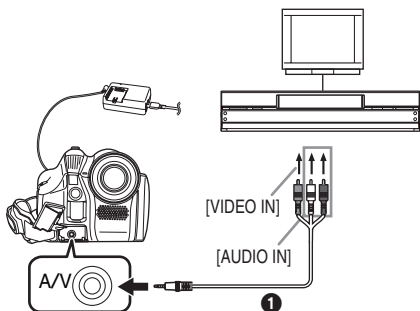

- Connect the movie camera and the recorder by using the AV cable ①.
- If your recorder is not equipped with AV Input Sockets, the 21-pin Adaptor (purchase separately) is necessary. Consult your dealer.

Connecting with the optional DV cable (Only for equipment with a DV terminal)

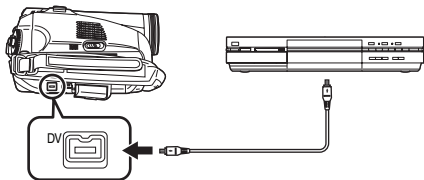

- 2 Turn on the movie camera and set to Tape Playback Mode.
- 3 Select the input channel on the TV set and recorder.
- 4 Move the joystick up to select the [▶/||] icon to start playback. (Player)
 - The image and sound are reproduced.
- 5 Start recording. (Recorder)
- 6 Stop recording. (Recorder)
- 7 Move the joystick down to select the [■] icon to stop playback. (Player)

- For more information, refer to the operating instructions for your TV set and recorder.
- When you do not need functional indications or date and time indication, set [BASIC] >> [DATE/TIME] >> [OFF] in the Tape Playback Mode and press the [EXT DISPLAY] button on the remote control for no indication. (When you connect the movie camera and a recorder with the DV cable, these indications may not appear.)

■ When neither image nor sound from the movie camera is output to the TV set

- Check that the plugs are inserted as far as they go.
- Check the [12bit AUDIO] settings. (-35-)
- Check the connected terminal.

Using the DV Cable for Recording (Digital Dubbing)

By connecting other digital video equipment with DV terminal and the movie camera by using the DV cable VW-CD1E (optional) ①, high-image-quality dubbing can be done in digital format.

This model cannot be used as a Recorder.

● **Set to Tape Playback Mode.**
(Player/recorder)

1 Connect the movie camera and digital video equipment with the DV cable.

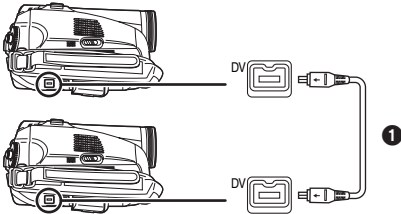

- 2 Start playback. (Player)**
- 3 Start recording. (Recorder)**
- 4 Stop playback. (Player)**

- Do not plug or unplug the DV cable during dubbing, or the dubbing may not be completed properly.
- Even if you use a device equipped with DV terminals such as IEEE1394, you may not be able to perform digital dubbing in some cases. For more information, see the instructions for equipment connected.
- Regardless of the menu settings on the recorder, digital dubbing is carried out in the same mode as the [AUDIO REC] mode of the playback tape.
- The images on the recorder monitor may be disturbed, but it does not affect the recorded images.

Audio dubbing (NV-GS37 only)

You can add music or narration to the recorded cassette.

(Audio dubbing can only be performed by using the remote control.)

● **Set to Tape Playback Mode.**

1 Find a scene that you want to add sound to, and press the [II] button on the remote control.

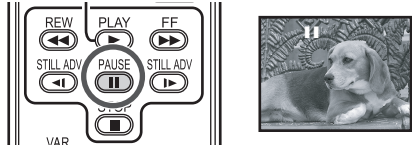

2 Press the [AUDIO DUB] button on the remote control to make audio dubbing ready.

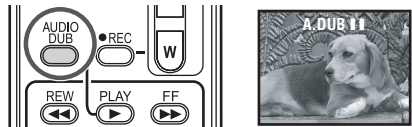

3 Press the [II] button on the remote control to start audio dubbing.

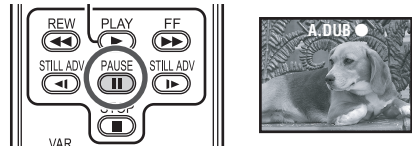

● Talk into the built-in microphone.

4 Press the [II] button on the remote control to stop audio dubbing.

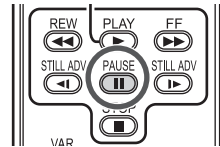

- If a tape has a non-recorded portion when the tape is dubbed, images and sounds may be disturbed when this portion of the tape is played back.

■ Before recording with audio dubbing**● Set to Tape Recording Mode.**

- When you want to preserve the original sound taken during recording, set [ADVANCED] >> [AUDIO REC] >> [12bit] to take pictures. (When set [16bit], the sounds taken during recording are erased after recording with audio dubbing.)
- Set [BASIC] >> [REC SPEED] >> [SP] to take pictures.

■ To play back the sound recorded with audio dubbing

You can switch between the sound recorded with audio dubbing and the original sound.

Set [SETUP] >> [12bit AUDIO] >> [ST2] or [MIX].

[ST1]: It only plays back the original sound.

[ST2]: It only plays back the sound added by audio dubbing.

[MIX]: It simultaneously plays back the original sound and the sound added with audio dubbing.

- During audio dubbing, it is automatically set to [ST2].

Menu

Menu list

Menu figures and illustrations are provided for easy-to-understand explanations, and so they are different from the actual menu indications.

■ [TAPE RECORDING MENU]

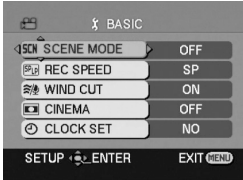

1) [BASIC]

[SCENE MODE] -27-

[REC SPEED] -21-

[WIND CUT] -26-

[CINEMA] -26-

[CLOCK SET] -10-

2) [ADVANCED]

[SIS] -27-

[FADE COLOUR] -26-

[AUDIO REC] -38-

[USB FUNCTION] (NV-GS37 only) (Refer to the operating instructions for PC connection.)

[D.ZOOM] -24-

[ZOOM MIC] -24-

[SHTR EFFECT] -23-

3) [SETUP]

[DISPLAY] -38-

[DATE/TIME] -38-

[POWER SAVE] -38-

[QUICK START] -12-

[REMOTE] (NV-GS37 only) -19-

[BEEP SOUND] -38-

[LCD SET] -17-

[EVF SET] -17-

[INITIAL SET] -38-

[DEMO MODE] -38-

4) [LANGUAGE] -16-

■ [TAPE PLAYBACK MENU]

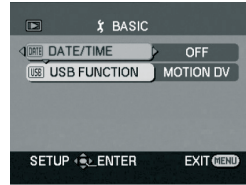

1) [BASIC]

[DATE/TIME] -38-

[USB FUNCTION] (NV-GS37 only) (Refer to the operating instructions for PC connection.)

2) [ADVANCED]

[REPEAT PLAY] -31-

3) [SETUP]

[12bit AUDIO] -36-

[AUDIO OUT] -38-

[DISPLAY] -38-

[REMOTE] (NV-GS37 only) -19-

[LCD SET] -17-

[EVF SET] -17-

[POWER SAVE] -38-

4) [LANGUAGE] -16-

Menus related to taking pictures

■ [DATE/TIME]

This switches between date and time indications.

- The movie camera automatically records the date and time of picture taking on the tape.
- You can also show or change the date/time indication by repeatedly pressing the [DATE/TIME] button on the remote control. (NV-GS37 only)

■ [AUDIO REC]

Switches the audio (PCM audio) recording systems.

- [12bit]: Records audio in "12 bit 32 kHz 4 tracks".
(The original audio signals can be kept after the other audio signals are dubbed.)
- [16bit]: Records audio in "16 bit 48 kHz 2 tracks".
Audio can be recorded in higher quality.
(If audio signals are dubbed, then the original audio signals will be erased.)

■ [DISPLAY]

Set to [ON] and the display mode can be switched to all functions. Set to [OFF] and it can be switched to minimum display.

■ [BEEP SOUND]

Set to [ON] and confirmation/alarm beeps are issued as follows.

1 Beep

- When you start recording
- When you turn on the power
- When the unit goes from quick start standby mode to recording pause

2 Beeps

- When you pause recording
- When you turn off the power
- When the unit goes into quick start standby mode

2 Beeps for 4 times

- When a cassette with its erasure prevention tab set to [SAVE] is inserted, condensation occurs (-45-), and at other times. Check the sentence displayed on the screen. (-40-)

■ [POWER SAVE]

[OFF]: When about 5 minutes passed without any operation, the standby mode automatically will be set. In the standby mode, [■] blinks and it takes time more than usual to start recording after you press the recording start/stop button.

[5 MINUTES]: When about 5 minutes passed without any operation, the movie camera automatically turns off to protect the tape or to prevent the battery from running down. When you use the movie camera, turn it on again.

- In the following cases, the power may not turn off even when set [POWER SAVE] >> [5 MINUTES].
 - When connecting to the AC outlet (When using the AC adapter)
 - When connecting the USB cable or the DV cable to a personal computer or other equipment

Menus related to playback

■ [AUDIO OUT]

This switches the sound to be played back.

[STEREO]: Stereo sound (main sound and sub sound)

[L]: Left channel sound (main sound)

[R]: Right channel sound (sub sound)

Other menus

■ [INITIAL SET]

When there is a menu that cannot be selected depending on a combination of functions, set to [YES] for changing the menu settings back to the initial shipping condition.

(Language setting cannot be back to the initial shipping condition.)

■ [DEMO MODE]

If you set to [DEMO MODE] >> [ON] without inserting a cassette, the movie camera is automatically set to the demonstration mode for introducing its functions. If any button is pressed or operated, the demonstration mode is cancelled. If no operations take place for approx. 10 minutes, the demonstration mode automatically starts. To terminate the demonstration mode, insert a cassette, or set to [DEMO MODE] >> [OFF]. For normal use, set this function to [OFF].

Others



















Indications





Various functions and the movie camera status are shown on the screen.

Basic indications



- : Remaining battery power
- 0h00m00s00f: Time code
- 15:30:45: Date/Time indication

Recording indications

- R0:45: Remaining tape time
- Remaining tape time is indicated in minutes. (When it reaches less than 3 minutes, the indication starts flashing.)
- SP: Standard Play mode (Recording speed mode) -21-
- LP: Long Play mode (Recording speed mode) -21-
- : Recording -22-
- || (Green): Recording pause -22-
- || (Green flash): Standby mode
- || (Red): Fade out
- : Recording check -22-
- : Automatic mode -21-
- : Manual mode -27-
- MF: Manual focus -29-
- 5×: Zoom magnification indication -24-
- : Back light mode -25-
- : Image stabilizer -27-
- 1/500: Shutter speed -30-
- F2.4: F number -30-
- 6dB: Gain value -30-
- : Soft skin mode -25-
- : Fade (White) -26-
- : Fade (Black) -26-
- : Colour night view function -25-
- : Blank search -23-
- : Video Light is on (NV-GS37 only) -20-
- +: Gain up -20-
- ZOOM : Zoom microphone -24-
- : Wind noise reduction -26-
- : Sports mode (Scene mode) -27-
- : Portrait mode (Scene mode) -27-
- : Low light mode (Scene mode) -27-
- : Spotlight mode (Scene mode) -27-
- : Surf & snow mode (Scene mode) -27-
- : Auto white balance -28-

- : Indoor mode (recording under incandescent lamp) -28-
- : Outdoor mode -28-
- : White balance adjustment mode -28-
- : WEB CAMERA mode (Recording)

Playback indications

- ▶▶: Playback -31-
- ||: Pause -31-
- ▶▶▶: Fast-forward/Cue playback -31-
- ◀◀: Rewind/Review playback -31-
- ▶/◀: Slow motion playback -32-
- |||/◀|||: Frame-by-frame playback -32-
- 2×▶▶▶: Variable-speed search -32-
- ▶▶: Repeat playback -31-
- A.DUB ●: Audio dubbing -35-
- A.DUB ||: Audio dubbing pause -35-
- 12bit, 16bit: Audio recording mode -38-
- : Volume adjustment -31-
- : WEB CAMERA mode (Playback)

Warning/alarm indications

If any one of the following indications lights up or flashes, please check the movie camera.

Confirmatory indications

: A cassette with the accidental erasure prevention slider placed in the [SAVE] position is inserted.
No cassette is inserted.

: The built-in battery is low. *-10-*



: The warning/alarm indication appears when you record yourself. Turn the LCD monitor towards the viewfinder and check the warning/alarm indication.

REMOTE :
An incorrect remote control mode has been selected. *-19-*

END:
The tape came to the end during recording.

: The video heads are dirty. *-45-*

Textual indications

 DEW DETECT/ EJECT TAPE:
Condensation has occurred. Take out the cassette and wait for a while. It takes some time until the cassette holder opens, but this is not a malfunction. *-45-*

LOW BATTERY:
The battery is low. Recharge it. *-8-*

NO TAPE :
No tape is inserted. *-13-*

TAPE END:
The tape came to the end during recording.

CHECK REC TAB:
You are attempting to record pictures on a tape with the accidental erasure prevention slider placed in the [SAVE] position.
You are attempting audio dubbing or digital dubbing on a tape with the accidental erasure prevention slider placed in the [SAVE] position.

CHECK REMOTE MODE:
An incorrect remote control mode has been selected. This is only displayed at the first operation of the remote control after powering-on. *-19-*

WRONG TAPE FORMAT:
You are attempting to play back a tape section that has been recorded with a different TV system. This cassette is incompatible.

CLOSE CASSETTE DOOR:
The cassette cover is open. Close the cassette cover. *-13-*

UNABLE TO A.DUB (LP RECORDED):
Audio dubbing cannot be performed because the original recording was in LP mode.

UNABLE TO A.DUB:
You are attempting to perform audio dubbing on a non-recorded tape.

COPY PROTECTED:
Images cannot be recorded correctly because the medium is protected by a copy guard.

NEED HEAD CLEANING:
The video heads are dirty. *-45-*

PUSH THE RESET SWITCH:
An irregularity in the equipment has been detected. Press the [RESET] button (*-6-*). This may solve the problem.

DISCONNECT USB CABLE:
You are attempting to record pictures on a tape with the USB cable connected to the movie camera.

PC DOES NOT SUPPORT USB2.0:
The movie camera is connected to a personal computer that does not support USB 2.0. (Refer to the operating instructions for PC connection.)

CAN NOT USE USB:
You are connecting the USB cable with the DV cable connected.

CHANGE TO MANUAL MODE:
You are attempting to select the item on the [SCENE MODE] when the [AUTO/MANUAL/FOCUS] switch is set to [AUTO].

CAN NOT OPERATE (MOTION DV MODE):
You are attempting to change [D.ZOOM] setting during MotionDV Mode.

REVERSE THE LCD MONITOR:
When the LCD monitor is rotated by 180° towards the lens, the brightness of the LCD monitor cannot be adjusted.

TURN OFF THE VIDEO LIGHT:
You are attempting to select an item in [SCENE MODE] when light is on.

CANCEL NIGHT VIEW MODE:
You are attempting to select an item other than [OFF] in [SCENE MODE] during night view mode.

Functions cannot be used simultaneously

Some functions in the movie camera are disabled or cannot be selected due to its specifications. The table below shows examples of functions restricted by conditions.

Functions	Conditions which disable the functions
<ul style="list-style-type: none"> ● Image stabilizer 	<ul style="list-style-type: none"> ● When the colour night view function is used ● When the built-in LED video light lights and the gain up mode is set to on (NV-GS37 only)
<ul style="list-style-type: none"> ● Backlight compensation 	<ul style="list-style-type: none"> ● When the iris/gain is set ● When the colour night view function is used ● When the built-in LED video light lights and the gain up mode is set to on (NV-GS37 only)
<ul style="list-style-type: none"> ● Help mode ● Blank search ● Soft skin ● Recording check 	<ul style="list-style-type: none"> ● While recording to a tape
<ul style="list-style-type: none"> ● Colour Night View 	<ul style="list-style-type: none"> ● While recording to a tape ● When the built-in LED video light lights and the gain up mode is set to on (NV-GS37 only)
<ul style="list-style-type: none"> ● Scene mode 	<ul style="list-style-type: none"> ● When setting the [AUTO/MANUAL/FOCUS] switch to [AUTO] ● When the colour night view function is used ● When the built-in LED video light lights (NV-GS37 only)
<ul style="list-style-type: none"> ● Change of white balance 	<ul style="list-style-type: none"> ● When digital zoom (30× or higher) is used ● When the colour night view function is used ● When the built-in LED video light lights and the gain up mode is set to on (NV-GS37 only)

<ul style="list-style-type: none"> ● Adjusting the shutter speed, iris/gain 	<ul style="list-style-type: none"> ● When the colour night view function is used ● When the scene mode is used ● When the built-in LED video light lights and the gain up mode is set to on (NV-GS37 only)
<ul style="list-style-type: none"> ● Variable-speed search (NV-GS37 only) 	<ul style="list-style-type: none"> ● During repeat playback
<ul style="list-style-type: none"> ● Audio dubbing (NV-GS37 only) 	<ul style="list-style-type: none"> ● The section of a tape recorded in LP mode ● The blank section of a tape

Before requesting repair (Problems and solutions)

Power/Body

1: The movie camera power cannot be turned on.

- Is the battery fully charged? Use a fully charged battery.
- The battery protection circuit may have operated. Attach the battery to the AC adaptor for 5 to 10 seconds. If the movie camera still cannot be used, the battery is faulty.
- Is the LCD monitor open or the viewfinder extend?

2: The movie camera power is turned off automatically.

- If you set [POWER SAVE] to [5 MINUTES] and do not operate the movie camera for about 5 continuous minutes, the power is automatically turned off for tape protection and power conservation. To resume recording, turn the [OFF/ON] switch to [OFF]. Then turn it to [ON] again. (-38-) Also, if you set [POWER SAVE] to [OFF], the power does not automatically turn off.

3: The movie camera power does not stay on long enough.

- Is the battery low? If the remaining battery power indication is flashing or the message "LOW BATTERY" is displayed, the battery has run down. Charge the battery or attach a fully charged battery. (-8-)
- Has condensation occurred? When you carry the movie camera from a cold place into a warm place, condensation may occur inside it. If so, the power is turned off automatically, disabling all operations except for taking cassettes out. Wait until the condensation indication disappears. (-45-)

4: Battery runs down quickly.

- Is the battery fully charged? Charge it with the AC adaptor. (-8-)
- Are you using the battery in an extremely cold place? The battery is affected by ambient temperature. In cold places, the operating time of the battery becomes shorter.
- Has the battery worn out? The battery has a limited life. If the operating time is still too short even after the battery is fully charged, depending on the usage, the battery has worn out and can no longer be used.

5: The movie camera cannot be operated though powered up.

The movie camera does not operate normally.

- The movie camera cannot be operated unless you open the LCD monitor or extend the viewfinder.
- Remove the cassette and then press the [RESET] button. (-44-) If normal conditions are not restored yet, turn off the power. Then, about 1 minute later, turn on the power again.

6: The cassette cannot be removed.

- Does the status indicator comes on when opening the cassette cover? (-13-) Make sure that the battery and the AC adaptor are properly connected. (-8-)
- Is the battery in use discharged? Charge the battery and remove the cassette.
- Close the cassette cover completely, and fully open it again. (-13-)

7: No operation other than cassette removal can be performed.

- Has condensation occurred? Wait until the condensation indication disappears. (-45-)

8: The remote control does not function. (NV-GS37 only)

- Has the button-type battery of the remote control run out? Replace it with a new button-type battery. (-18-)
- Is the setting on the remote control correct? If the setting on the remote control is not in agreement with the [REMOTE] setting on the movie camera, the remote control does not operate. (-19-)

Recording

1: Recording does not start although power is supplied to the movie camera and the cassette is correctly inserted.

- Is the accidental erasure prevention slider on the cassette open? If it is open (set to [SAVE]), recording cannot be performed. (-13-)
- Is the tape wound to the end? Insert a new cassette.
- Is the recording mode set? When in the playback mode, recording cannot be performed. (-21-)
- Has condensation occurred? No operation other than cassette removal can be performed when condensation occurs. Wait until the condensation indication disappears. (-45-)
- Is the cassette cover open? If the cover is open, the movie camera may not operate normally. Close the cassette cover. (-13-)

2: The screen has changed suddenly.

- Has the demonstration started? In the Tape Recording mode, if you set [DEMO MODE] >> [ON] without inserting a cassette, the demonstration starts. For normal use, set this function to [OFF]. (-38-)

3: A cassette cannot be inserted.

- Has condensation occurred? Wait until the condensation indication disappears.

4: Auto focus function does not work.

- Is manual focus mode selected? If auto focus mode is selected, focus is automatically adjusted.
- There are some recording subjects and surroundings for which the auto focus does not operate correctly. (-49-) If so, use the manual focus mode to adjust the focus. (-29-)
- Is the colour night view function set? When the colour night view function is working, focusing shifts into the manual mode.

Indications**1: A sentence is displayed in red in the screen centre.**

- Read the contents and respond to them. (-40-)

2: The time code becomes inaccurate.

- The time code indication counter may not be constant in the reversed slow-motion playback, but this is not a malfunction.

3: The remaining tape time indication disappears.

- The remaining tape time indication may disappear temporarily during frame-by-frame playback or other operation. If you continue ordinary recording or playback, the indication is restored.

4: The remaining tape time indication does not match the actual remaining tape time.

- If scenes of less than 15 seconds are continuously recorded, the remaining tape time cannot be correctly displayed.
- In some cases, the remaining tape time indication may show remaining tape time that is 2 to 3 minutes shorter than the actual remaining tape time.

5: A function indication such as mode indication, remaining tape time indication, or time code indication is not shown.

- If you set [SETUP] >> [DISPLAY] >> [OFF], indications other than the tape running condition, warning, and date indications disappear.

Playback (Sound)**1: Sound is not played back from the built-in speaker of the movie camera.**

- Is the volume too low? During playback, push the [-VOLUME+] lever to display the volume indication and adjust it. (-31-)

2: Different sounds are reproduced at the same time.

- Have you set [SETUP] >> [12bit AUDIO] >> [MIX]? If you set [AUDIO REC] >> [12bit] and dub audio to a recorded tape, you can hear the sound on recording and the sound dubbed at a later time. To hear the sounds separately, set to [ST1] or [ST2]. (-36-)
- Have you set [SETUP] >> [AUDIO OUT] >> [STEREO] and reproduced a picture containing the main sound and sub sound? Set to [L] to hear main sound, and set to [R] to hear the sub sound. (-38-)

3: Audio dubbing cannot be performed. (NV-GS37 only)

- Is the accidental erasure prevention slider on the cassette open? If it is open (set to [SAVE]), audio dubbing cannot be performed. (-13-)
- Are you attempting to edit a tape portion that was recorded in LP mode? LP mode does not allow audio dubbing. (-21-)

4: The original sound was erased when audio dubbing was performed. (NV-GS37 only)

- If you perform audio dubbing on a recording made in [16bit] mode, the original sound will be erased. If you wish to preserve the original sound, be sure to select [12bit] mode when recording.

5: Sounds cannot be played back.

- Although a cassette with no audio dubbing is being played, have you set [SETUP] >> [12bit AUDIO] >> [ST2]? To play back a cassette with no audio dubbing, set [12bit AUDIO] >> [ST1]. (-36-)
- Is the variable speed search function working? Press the [VAR SEARCH] button on the remote control to cancel the variable speed search function. (NV-GS37 only) (-32-)

Playback (Pictures)**1: Mosaic-pattern noise appears on images during cue or review playback.**

- This phenomenon is characteristic of digital video systems. It is not a malfunction.

2: Horizontal stripes appear on images during cue and review playback.

- Horizontal stripes may appear depending on the scene, but this is not a malfunction.

3: Although the movie camera is correctly connected to a TV, playback images cannot be seen.

- Have you selected video input on the TV? Please read the operating instructions of your TV and select the channel that matches the input terminals used for the connection.

4: Playback picture is not clear.

- Are the heads of the movie camera dirty? If the heads are dirty, playback image cannot be clear. Clean the heads by using the head cleaner for digital video (optional). (-45-)
- If the terminal for the AV cable is soiled, noises may appear on the screen. Wipe the soil off the terminal with a soft cloth, and then connect the cable to the AV terminal.
- Is a picture containing a copyright protection signal (copy guard) being recorded? When a protected picture is played back by the movie camera, mosaic-like patterns appear on the picture.

Others**1: The indication disappears, the screen is frozen, or no operation can be performed.**

- Turn off the power to the movie camera. If the power cannot be turned off, press the [RESET] button, or detach the battery or the AC adaptor and then reattach it. After that, turn on the power again. If normal operation is still not restored, detach the power connected, and consult the dealer who you purchased the movie camera from.

2: "PUSH THE RESET SWITCH" is displayed.

- An irregularity in the movie camera has been automatically detected. Remove the cassette for data protection and then press the [RESET] button. The movie camera will be activated.
- If you do not press the [RESET] button, the power to the movie camera is turned off automatically about 1 minute later.
- Even after you press the [RESET] button, the indication may still appear repeatedly. If so, the movie camera needs repair. Detach the power connected, and consult the dealer who you purchased the movie camera from. Do not attempt to repair the appliance by yourself.

3: Even if connected by the USB cable, the movie camera is not recognized by the PC.

- Is the USB driver installed? For information, refer to the operating instructions for PC connection (separate volume).

4: When the USB cable is disconnected, an error message will appear on PC.

- To disconnect the USB cable safely, double-click the  icon in the task tray and follow the instructions on the screen.

5: The movie camera malfunctions on editing, dubbing from digital video equipment, or using "MotionDV STUDIO 5.6E LE for DV" or "SweetMovieLife". (NV-GS37 only)

- If a tape is recorded in multiple modes such as SP and LP (recording mode), 12 bit and 16 bit (sound recording mode), normal and wide, recorded and unrecorded parts, the movie camera may malfunction at a point where the mode switches. When you edit, do not record in multiple modes.

6: The warning/alarm indication [] appears when the camera is operated in the WEB camera mode.

- Did you press the menu button or the recording start/stop button? You cannot use the menu or record onto the tape in the WEB camera mode.
- Is the setting for the remote control correct?
- Did you attempt to play a tape without inserting it? Insert a tape.
- Did you attempt to play a tape with copyright protection (copy guard)? Pictures of the tape with copyright protection (copy guard) cannot be displayed on the PC. (The audio of the tape can be played.)
- Is the USB driver installed? For details, refer to the operating instructions for PC connection.

Cautions for Use

■ About condensation

If you turn the movie camera on when condensation occurs on the head or the tape, condensation Indication [] is displayed on the viewfinder or the LCD monitor and the messages [] DEW DETECT] or [] EJECT TAPE] (only when the tape is inserted) appear. If so, follow the procedure below.

1 Remove the tape if it is inserted.

- It takes about 20 seconds to open the cassette holder. This is not a malfunction.

2 Leave the movie camera with the cassette cover closed to cool or warm it to the ambient temperature.

- The status indicator blinks for about 1 minute and then the movie camera automatically turns off. Leave it for about 1.5 to 2 hours.

3 Turn the movie camera on again, set it to the Tape Recording/Playback Mode and then check if the condensation indication disappears.

Especially in cold areas, moisture may be frozen. If so, it may take more time before the condensation indication disappears.

Watch for condensation even before the condensation indication is displayed.

- If the indicator of the condensation does not display on the LCD monitor and/or the viewfinder and you notice condensation on the lens or the main unit, do not open the cassette cover otherwise condensation may be formed on the heads or the cassette tape.

When the lens is fogged:

Set the [OFF/ON] switch to [OFF] and leave the movie camera in this condition for about 1 hour. When the lens temperature becomes close to the ambient temperature, the fogging disappears naturally.

■ About dirty heads

If video heads (the parts that closely contact with the tape) become dirty, normal recording and playback are not properly performed.

Clean the heads with the digital video head cleaner.

- Insert the head cleaner into the movie camera, set it to the Tape Playback Mode, and play it back for about 10 seconds. (If you do not stop the playback, it automatically stops about 15 seconds later.)
 - We recommend cleaning the heads periodically.
- If the heads become dirty, "NEED HEAD CLEANING" appears during recording. During playback, moreover, the following symptoms appear.**
- Mosaic-like noise appears partially or the sound is interrupted.
 - Black or blue mosaic-like horizontal stripes appear.
 - The whole screen becomes black and there is no picture and sound.

When normal playback cannot be performed even after the head cleaning.

One possible cause is that normal recording could not be performed because the heads were dirty at the time of recording. Clean the heads, and perform recording and playback again. If normal playback can be performed, the heads are clean. Before an important recording, be sure to conduct a test recording to make sure that normal recording can be performed.

- If the heads become dirty soon after cleaning, the problem may be attributable to the tape. If so, try another cassette.
- During playback, the picture or sound may be interrupted momentarily, but this is not a malfunction of the movie camera. (One possible cause is that the playback is interrupted by dirt or dust that momentarily adheres to the heads.)

■ About the movie camera

- When the movie camera is used for a long time, the camera body becomes warm, but this is not a malfunction.

Keep the movie camera away from magnetized equipment such as a cellular phones, microwave ovens, TVs, and video game equipment.

- If you use the movie camera on or near a TV, images or sounds may be disturbed due to electromagnetic wave radiation.
- Recordings on the tape may be damaged, or images may be distorted, by strong magnetic fields created by speakers or large motors.
- Electromagnetic wave radiation generated by digital circuits including microprocessor may adversely affect the movie camera, causing the disturbance of images and sounds.
- If the movie camera is affected by such equipment and does not function properly, turn off the movie camera power and detach the battery or the AC adaptor. Then, connect the battery or the AC adaptor again and turn on the movie camera power.

Do not use your movie camera near radio transmitters or high-voltage cables.

- If you record pictures near radio transmitters or high-voltage cables, recorded images or sounds may be adversely affected.

Do not spray insecticides or volatile chemicals onto the movie camera.

- If the movie camera is sprayed with such chemicals, the camera body may become deformed and the surface finish may peel off.
- Do not keep rubber or plastic products in contact with the movie camera for a long time.

When you use your movie camera in a sandy or dusty place such as on a beach, do not let sand or fine dust get into the body and terminals of the movie camera. Also, protect the movie camera from getting wet.

- Sand or dust may damage the movie camera or cassette. (Care should be taken when inserting and removing a cassette.)
- If sea water splashes onto the movie camera, wet a soft cloth with tap water, wring it well, and use it to wipe the camera body carefully. Then, wipe it again thoroughly with a soft dry cloth.

While carrying the movie camera, do not drop or bump it.

- A strong impact on the movie camera may break its housing, causing it to malfunction.

Do not use benzine, paint thinner or alcohol for cleaning the movie camera.

- Before cleaning, detach the battery or pull out the AC mains lead from the AC mains socket.
- The camera body may be discoloured and the surface finish may peel off.
- Wipe the movie camera with a soft dry cloth to remove dust and fingerprints. To remove stubborn stains, wring well a cloth that is soaked in a neutral detergent diluted with water and wipe the movie camera with it. Afterwards, wipe it with a dry cloth.
- When you use a chemical dust cloth, follow the instructions.

Do not use this movie camera for surveillance purposes or other business use.

- If you use the movie camera for a long time, the internal temperature increases and, consequently, this may cause malfunction.
- This movie camera is not intended for business use.

When you are not going to use the movie camera for an extended time.

- When storing the unit in a cupboard or a cabinet, it is recommended that you put a desiccant (silica gel) in with it.

■ About the battery

The battery used in the movie camera is a rechargeable lithium ion battery. This battery is susceptible to temperature and humidity, and the effect of temperature increases with increasing or decreasing temperature. In the low temperature range, the fully charged indication may not appear, or the low battery indication may appear about 5 minutes after the start of use. At high temperature, moreover, the protection function may work, disabling use of the movie camera.

Be sure to detach the battery after use.

- If the battery is left attached to the movie camera, a minute amount of current is consumed even when the movie camera power is [OFF]. If the battery is left attached to the movie camera for a long time, over-discharge takes place. The battery may become unusable after it is charged.
- The battery should be stored in a cool place free from humidity, with as constant temperature as possible. (Recommended temperature: 15 °C to 25 °C, Recommended humidity: 40% to 60%)
- Extremely high temperatures or low temperatures will shorten the life of the battery.
- If the battery is kept in a high-temperature, high-humidity, or oily-smoky places, the terminals may rust and cause malfunctions.

- To store the battery for a long period of time, we recommend you charge it once every year and store it again after you have completely used up the charged capacity.

- Dust and other matter attached to the battery terminals should be removed.

Prepare spare batteries when going out for recording.

- Prepare batteries appropriate to 3 to 4 times the period during you want to record pictures in. In cold places such as a ski resort, the period during which you can record pictures is shortened.

- When you travel, do not forget to bring an AC adaptor so that you can recharge the batteries at your destination.

If you drop the battery accidentally, check to see if the terminals are deformed.

- Attaching a deformed battery to the movie camera or the AC adaptor may damage the movie camera or the AC adaptor.

Do not throw old battery into fire.

- Heating a battery or throwing it into a fire may result in an explosion.
- If the operating time is very short even after the battery has been recharged, the battery has worn out. Please purchase a new battery.

■ About the AC adaptor

- If the battery is warm, charging requires more time than normal.
- If the temperature of the battery is extremely high or extremely low, the [CHARGE] lamp may continue flashing, and the battery may not be charged. After the battery temperature has decreased or increased sufficiently, recharging starts automatically. So, wait for a while. If the lamp still continues flashing even after the recharging, the battery or the AC adaptor may be faulty. If so, please contact a dealer.
- If you use the AC adaptor near a radio, radio reception may be disturbed. Keep the AC adaptor 1 metre or more away from radio.
- When using the AC adaptor, it may generate whirring sounds. However, this is normal.
- After use, be sure to pull out the AC mains lead from the AC mains socket. (If they are left connected, a minute amount of current is consumed.)
- Always keep the electrodes of the AC adaptor and the battery clean.

■ About the cassette

Never place the cassette in a high temperature place.

- The tape may be damaged, producing mosaic-like noise at the time of playback.

When storing the cassette after use, be sure to rewind the tape to the beginning and take it out.

- If the cassette is left for more than 6 months (depending on the storage condition) in the movie camera or stopped midway, the tape may sag and be damaged.

- Once every 6 months, wind the tape to the end and then rewind it to the beginning. If the cassette is left for 1 year or longer without winding or rewinding, the tape may be deformed by expansion or shrinkage attributable to temperature and humidity. The wound tape may stick to itself.

- Dust, direct sunlight (ultraviolet rays), and humidity may damage the tape. Such usage may cause damage to the movie camera and the heads.

- After use, be sure to rewind the tape to the beginning, put the cassette in the case to protect it from dust, and store it upright.

Keep the cassette away from strong magnetism.

- Apparatuses using magnets such as magnetic necklaces and toys have magnetic force that is stronger than expected, and they may erase the contents of a recording or may increase noise.

■ LCD monitor/viewfinder

LCD monitor

- When the LCD monitor gets dirty, wipe it with a dry soft cloth.
- In a place with drastic temperature changes, condensation may form on the LCD monitor. Wipe it with soft dry cloth.
- If your movie camera is extremely cold, the LCD monitor is slightly darker than usual immediately after you turn the power on. However, as the internal temperature increases, it goes back to normal brightness.

Extremely high precision technology is employed to produce the LCD monitor screen featuring a total of approximately 105,000 pixels. The result is more than 99.99% effective pixels with a mere 0.01% of the pixels inactive or always lit. However, this is not a malfunction and does not affect the recorded picture.

Viewfinder

Extremely high precision technology is employed to produce the viewfinder screen featuring a total of approximately 67,500 pixels for NV-GS27 and approximately 113,000 pixels for NV-GS37. The result is more than 99.99% effective pixels with a mere 0.01% of the pixels inactive or always lit. However, this is not a malfunction and does not affect the recorded picture.

■ Periodical check-ups

- To maintain the highest image quality, we recommend replacing worn parts such as heads after approx. 1000 hours of use. (This, however, depends on operating conditions including temperature, humidity and dust.)

Explanation of terms

■ Automatic white balance

White balance adjustment recognizes the colour of light and adjusts so the white colour will become a pure white. The movie camera determines the hue of light that comes through the lens and white balance sensor, thereby judging the recording condition, and selects the closest hue setting. This is called automatic white balance adjustment. However, since the movie camera only stores white colour information under several light sources, automatic white balance adjustment does not function normally under the other light sources.

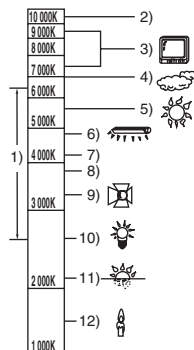

Outside of the effective range of automatic white balance adjustment, the image will become reddish or bluish. Even within the effective range of automatic white balance adjustment, the automatic white balance adjustment may not function properly if there is more than one light source. For light outside the functional auto white balance adjustment range, use the manual white balance adjustment mode.

- 1) The effective range of automatic white balance adjustment on this movie camera
- 2) Blue sky
- 3) TV screen
- 4) Cloudy sky (rain)
- 5) Sunlight
- 6) White fluorescent lamp
- 7) 2 hours after sunrise or before sunset
- 8) 1 hour after sunrise or before sunset
- 9) Halogen light bulb
- 10) Incandescent light bulb
- 11) Sunrise or sunset
- 12) Candlelight

■ White balance

The image recorded by the movie camera may become bluish or reddish under the influence of light sources. To avoid such phenomena, adjust the white balance.

White balance adjustment determines the white colour under different light sources. By recognizing which is the white colour under sunlight and which is the white colour under a fluorescent lamp, the movie camera can adjust the balance among the other colours.

Since white colour is the reference of all colours (light), the movie camera can record pictures in a natural hue if it can recognize the reference white colour.

■ Auto focus

Auto focus automatically moves the focusing lens forward and backward inside the movie camera to bring the subject into focus.

Auto focus has the following characteristics.

- Adjusts so that the vertical lines of a subject are seen more clearly.
- Attempts to bring an object with higher contrast into focus.
- Focuses on the screen centre only.

Due to these characteristics, auto focus does not work correctly in the following situations. Record pictures in the manual focus mode.

Recording a subject with one end located closer to the movie camera and the other end farther away from it

- As auto focus adjusts at the centre of an image, it may be impossible to focus on a subject that is located in both the foreground and background.

Recording a subject behind dirty or dusty glass

- The subject behind the glass will not be focused because the focus is on the dirty glass.

Recording a subject that is surrounded by objects with glossy surfaces or by highly reflective objects

- The recording subject may become blurry because the movie camera focuses on the objects with glossy surfaces or on highly reflective objects.

Recording a subject in dark surroundings

- The movie camera cannot focus correctly because the light information that comes through the lens decreases considerably.

Recording a fast-moving subject

- As the focus lens-inside moves mechanically, it cannot keep up with a fast-moving subject.

Recording a subject with little contrast

- A subject with little contrast, such as a white wall, may become blurry because the movie camera achieves focus based upon the vertical lines of an image.

Specifications

Specifications

Digital Video Camera

Information for your safety

Power source:

DC 7.9/7.2 V

Power consumption:

Recording
2.5 W (When using viewfinder)
3.1 W (When using LCD monitor)

Recording format:

Mini DV (Consumer-use digital video SD format)

Tape used:

6.35 mm digital video tape

Recording/playback time:

SP: 80 min; LP: 120 min (with DVM80)

Video
Recording system:

Digital component

Television system:

CCIR: 625 lines, 50 fields PAL colour signal

Audio
Recording system:

PCM digital recording
16 bit (48 kHz/2 ch), 12 bit (32 kHz/4 ch)

Image sensor:

1/6-inch CCD image sensor

Lens:

Auto Iris, F1.8 to F3.9,
Focal length; 1.9 mm to 57.0 mm
Macro (Full range AF)

Filter diameter:

30.5 mm

Zoom:

30:1 Power zoom

Monitor:

2.5-inch LCD

Viewfinder:

(NV-GS37) Colour electronic viewfinder
(NV-GS27) Electronic viewfinder

Microphone:

Stereo (with a zoom function)

Speaker:

1 round speaker \varnothing 20 mm

Standard illumination:

1,400 lx

Minimum required illumination:

2 lx (Colour Night View Mode)

Video output level:

1.0 Vp-p, 75 Ω

Audio output level (Line):

316 mV, 600 Ω

USB:

USB 2.0 compliant, (Hi-Speed) (NV-GS37)
(Full-Speed) (NV-GS27)
No copyright protection support

Digital interface:

DV output terminal (IEEE1394, 4-pin)

Dimensions:

Approx. 82 mm (W)×69 mm (H)×120 mm (D)
(excluding the projection part)

Mass:

Approx. 410 g
(without supplied battery, DV cassette and lens cap)
Approx. 480 g
(with supplied battery, DV cassette and lens cap)

Operating temperature:

0 °C to 40 °C

Operating humidity:

10% to 80%

WEB camera
Compression:

Motion JPEG

Image size:

320×240 pixels (QVGA)

Frame rate:

Approx. 6 fps

AC adaptor

VSK0651

Information for your safety

Power source:

AC 110 V to 240 V, 50/60 Hz

Power consumption:

19 W

DC output:

DC 7.9 V, 1.4 A (Movie camera operation)
DC 8.4 V, 0.65 A (Battery charging)

Dimensions:

Approx. 61 mm (W)×32 mm (H)×91 mm (D)

Mass:

Approx. 110 g

Mass and dimensions are approximate values.
Specifications may change without prior notice.

Index

■ A		
AC Adaptor	8, 47	
Aperture	30	
Audio Dubbing	35	
■ B		
Backlight Compensation	25	
Built-in LED Video Light	20	
■ C		
Charging the Battery	8	
Cinema Function	26	
Colour Night View Function	25	
Condensation	45	
■ D		
Digital Dubbing	35	
Digital Zoom	24	
Dubbing	34	
■ E		
Erasure Prevention Slider	13	
■ F		
Fade	26	
Frame-by-frame playback	32	
■ L		
LCD Monitor	48	
Low Light Mode	27	
■ M		
Manual Focus	29	
Mode Dial	14	
■ P		
Portrait Mode	27	
■ R		
Recording Speed	21	
Remaining Tape Time	39	
Remote Control	18	
Repeat Playback	31	
■ S		
Scene mode	27	
Self-Recording	24	
Shutter Speed	30	
Slow Motion Playback	32	
Soft Skin Mode	25	
Sound Volume	31	
SP/LP Mode	21	
Sports Mode	27	
Spotlight Mode	27	
Surf & Snow Mode	27	
■ V		
Video Head Clogging	45	
Viewfinder	48	
■ W		
White Balance	28	
■ Z		
Zoom	24	
Zoom Microphone	24	

B

LSQT1006 A DataSheet4U.com
F1205Nm0 (20000 (A))

C



Matsushita Electric Industrial Co., Ltd.
Web site: <http://www.panasonic.co.jp/global/>