

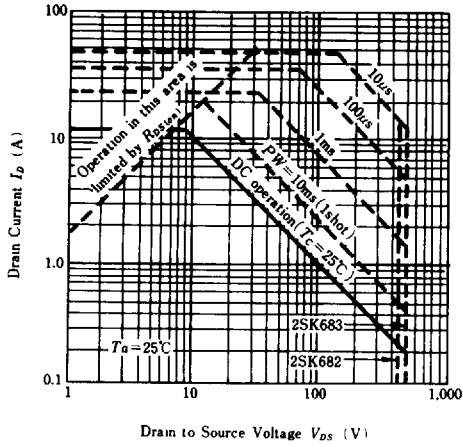

**MAXIMUM SAFE OPERATION AREA**

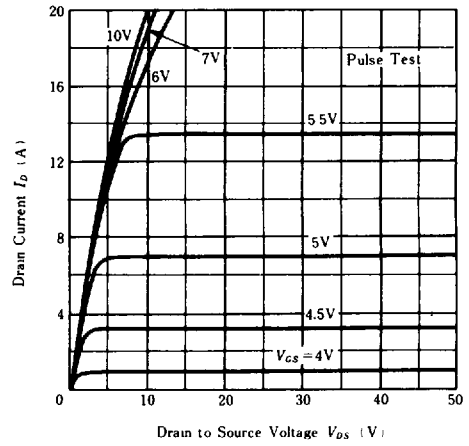

**TYPICAL OUTPUT CHARACTERISTICS**



**TYPICAL TRANSFER CHARACTERISTICS**

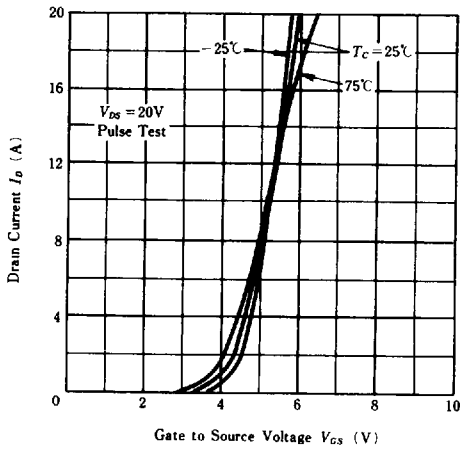

**DRAIN-SOURCE SATURATION VOLTAGE VS. GATE-SOURCE VOLTAGE**

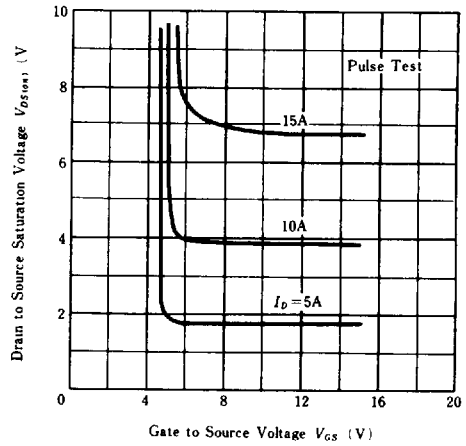

**STATIC DRAIN-SOURCE ON STATE RESISTANCE VS. DRAIN CURRENT**

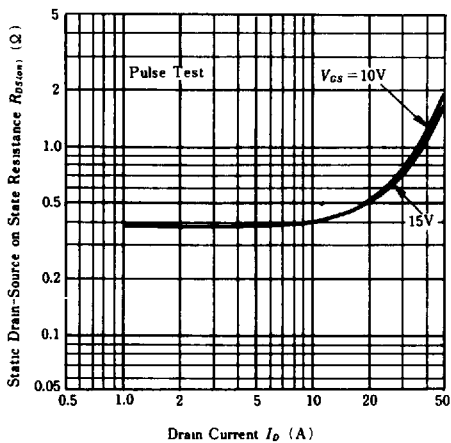

**STATIC DRAIN-SOURCE ON STATE RESISTANCE VS. TEMPERATURE**

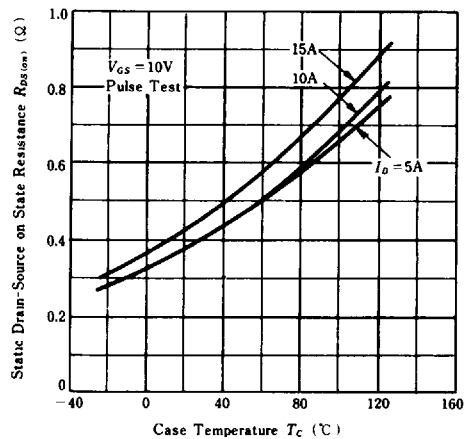

HITACHI/(OPTOELECTRONICS)

www.DataSheet4U.com

**FORWARD TRANSFER ADMITTANCE VS. DRAIN CURRENT**

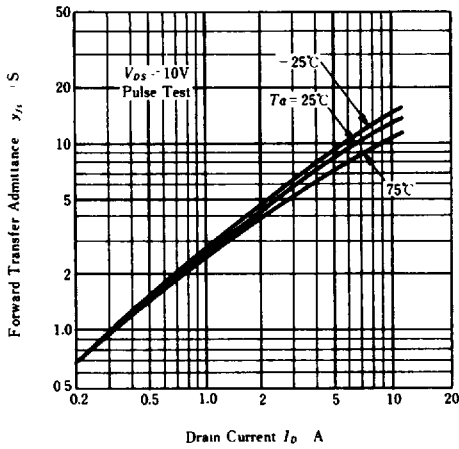

**BODY DRAIN DIODE REVERSE RECOVERY TIME**

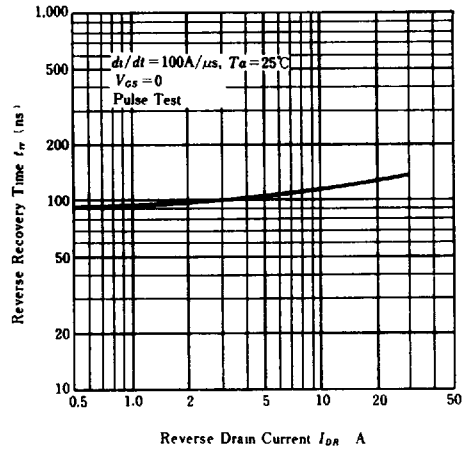

**TYPICAL CAPACITANCE VS. DRAIN-SOURCE VOLTAGE**

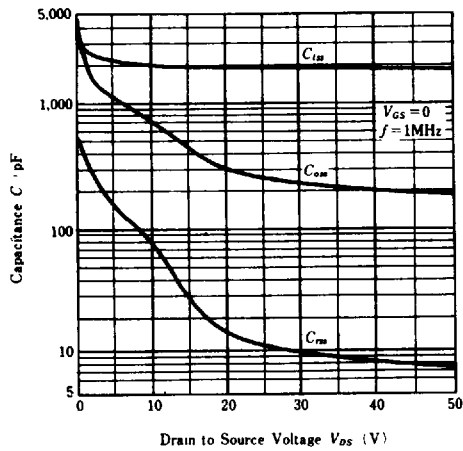

**DYNAMIC INPUT CHARACTERISTICS**

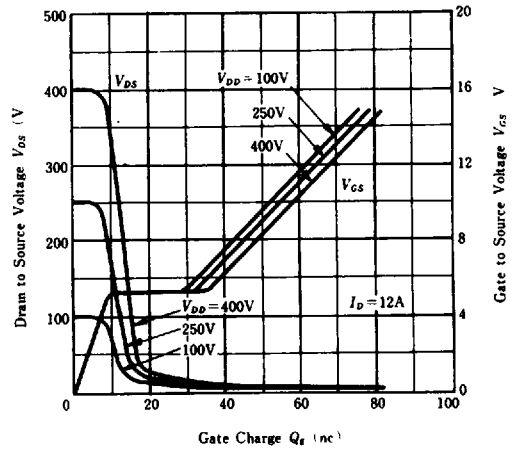

**SWITCHING CHARACTERISTICS**

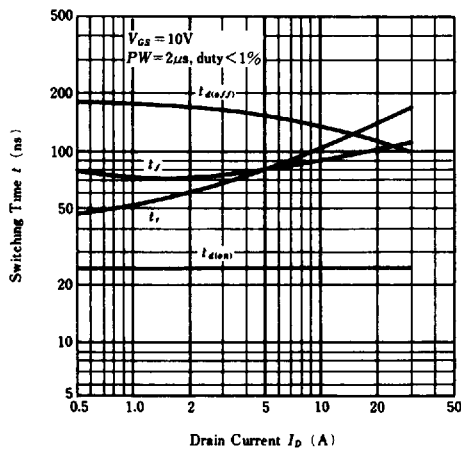

**REVERSE DRAIN CURRENT VS. SOURCE TO DRAIN VOLTAGE**

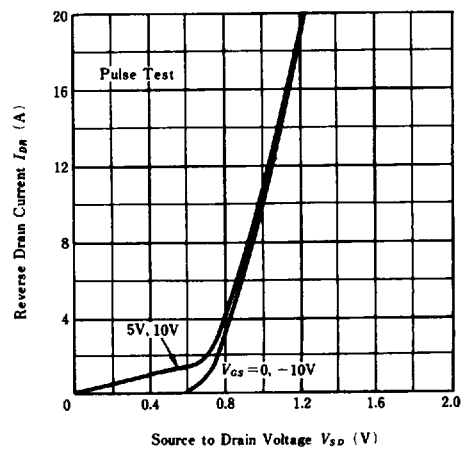

**NORMALIZED TRANSIENT THERMAL IMPEDANCE VS. PULSE WIDTH**

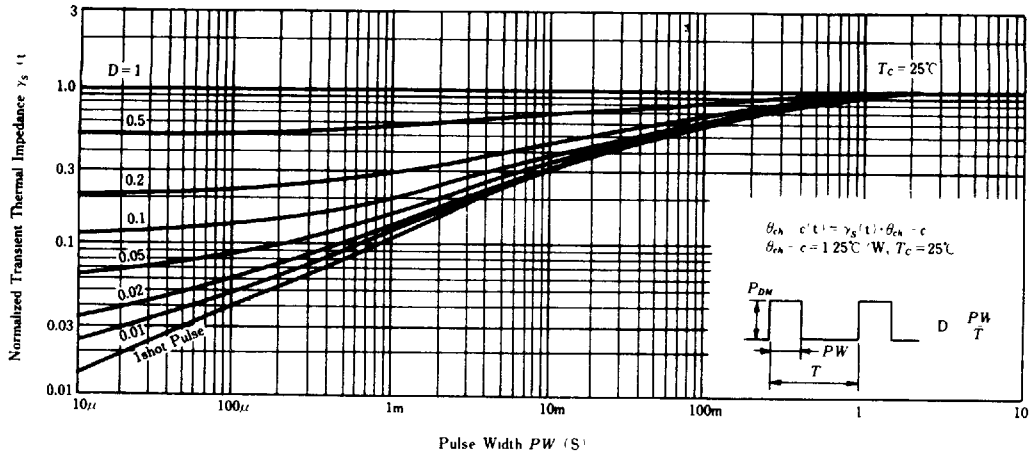

**SWITCHING TIME TEST CIRCUIT**

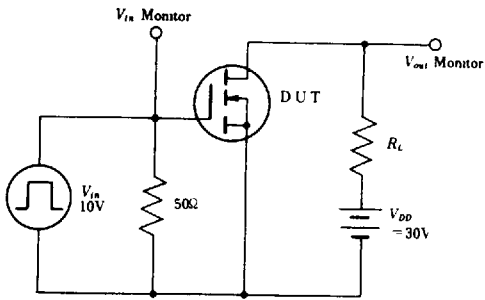

**WAVEFORMS**

