



TV22..F

Fast Recovery Diode

Replaces March 1998 version, DS4210-2.2

DS4210-3.0 January 2000

APPLICATIONS

- Induction Heating
- A.C. Motor Drives
- Snubber Diode
- Welding
- High Frequency Rectification
- UPS

FEATURES

- Thermal Fatigue Free Pressure Contact
- High Surge Capability
- Low Recovery Charge

VOLTAGE RATINGS

Type Number	Repetitive Peak Reverse Voltage V_{RRM} V	Conditions
TV22 16F M or K	1600	$V_{RSM} = V_{RRM} + 100V$
TV22 14F M or K	1400	
TV22 12F M or K	1200	
TV22 10F M or K	1000	
TV22 08F M or K	800	
TV22 06F M or K	600	

For 3/4" 16 UNF thread, add suffix K, e.g. TV22 16FK.

For M16 thread, add suffix M, e.g. TV22 16FM.

For stud anode add 'R' to type number, e.g. TV22 16FMR.

KEY PARAMETERS

V_{RRM}	1600V
$I_{F(AV)}$	305A
I_{FSM}	5000A
Q_r	70 μ C
t_{rr}	3.2 μ s

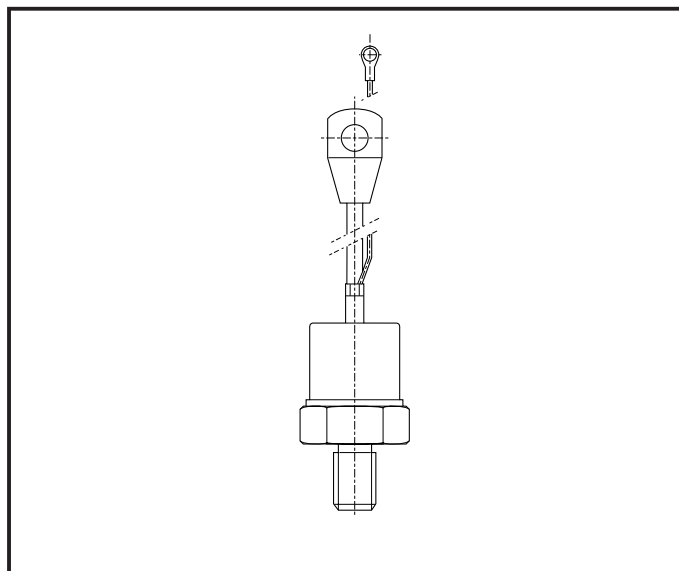

Outline type codes: DO9.

See Package Details for further information.

CURRENT RATINGS

Symbol	Parameter	Conditions	Max.	Units
$I_{F(AV)}$	Mean forward current	Half wave resistive load, $T_{case} = 65^{\circ}C$	305	A
$I_{F(RMS)}$	RMS value	$T_{case} = 65^{\circ}C$	346	A

TV22..F

SURGE RATINGS

Symbol	Parameter	Conditions	Max.	Units
I_{FSM}	Surge (non-repetitive) forward current	10ms half sine; with 0% V_{RRM} , $T_j = 150^\circ\text{C}$	5.0	kA
I^2t	I^2t for fusing		125×10^3	A^2s
I_{FSM}	Surge (non-repetitive) forward current	10ms half sine; with 50% V_{RRM} , $T_j = 150^\circ\text{C}$	-	kA
I^2t	I^2t for fusing		-	A^2s

THERMAL AND MECHANICAL DATA

Symbol	Parameter	Conditions	Min.	Max.	Units
$R_{th(j-c)}$	Thermal resistance - junction to case	dc	-	0.16	$^\circ\text{C}/\text{W}$
$R_{th(c-h)}$	Thermal resistance - case to heatsink	Mounting torque 35.0Nm with mounting compound	-	0.06	$^\circ\text{C}/\text{W}$
T_{vj}	Virtual junction temperature	On-state (conducting)	-	150	$^\circ\text{C}$
T_{stg}	Storage temperature range		-55	175	$^\circ\text{C}$
-	Mounting torque		30.0	35.0	Nm

CHARACTERISTICS

Symbol	Parameter	Conditions	Typ.	Max.	Units
V_{FM}	Forward voltage	At 750A peak, $T_{case} = 25^\circ\text{C}$	-	1.6	V
I_{RRM}	Peak reverse current	At V_{RRM} , $T_{case} = 150^\circ\text{C}$	-	40	mA
t_{rr}	Reverse recovery time	$I_F = 750\text{A}$, $di_{RR}/dt = 100\text{A}/\mu\text{s}$ $T_{case} = 125^\circ\text{C}$, $V_R = 100\text{V}$	-	3.2	μs
Q_{RA1}	Recovered charge (50% chord)		-	70	μC
I_{RM}	Reverse recovery current		-	43	A
K	Soft factor		1.8	-	-
V_{TO}	Threshold voltage	At $T_{vj} = 150^\circ\text{C}$	-	1.0	V
r_T	Slope resistance	At $T_{vj} = 150^\circ\text{C}$	-	0.8	$\text{m}\Omega$
V_{FRM}	Forward recovery voltage	$di/dt = 1000\text{A}/\mu\text{s}$, $T_j = 125^\circ\text{C}$	-	-	V

DEFINITION OF K FACTOR AND Q_{RA1}

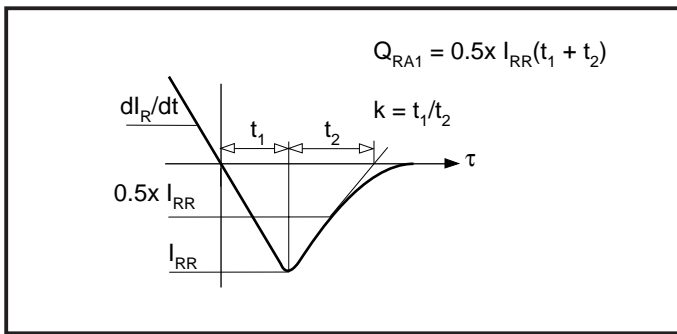

CURVES

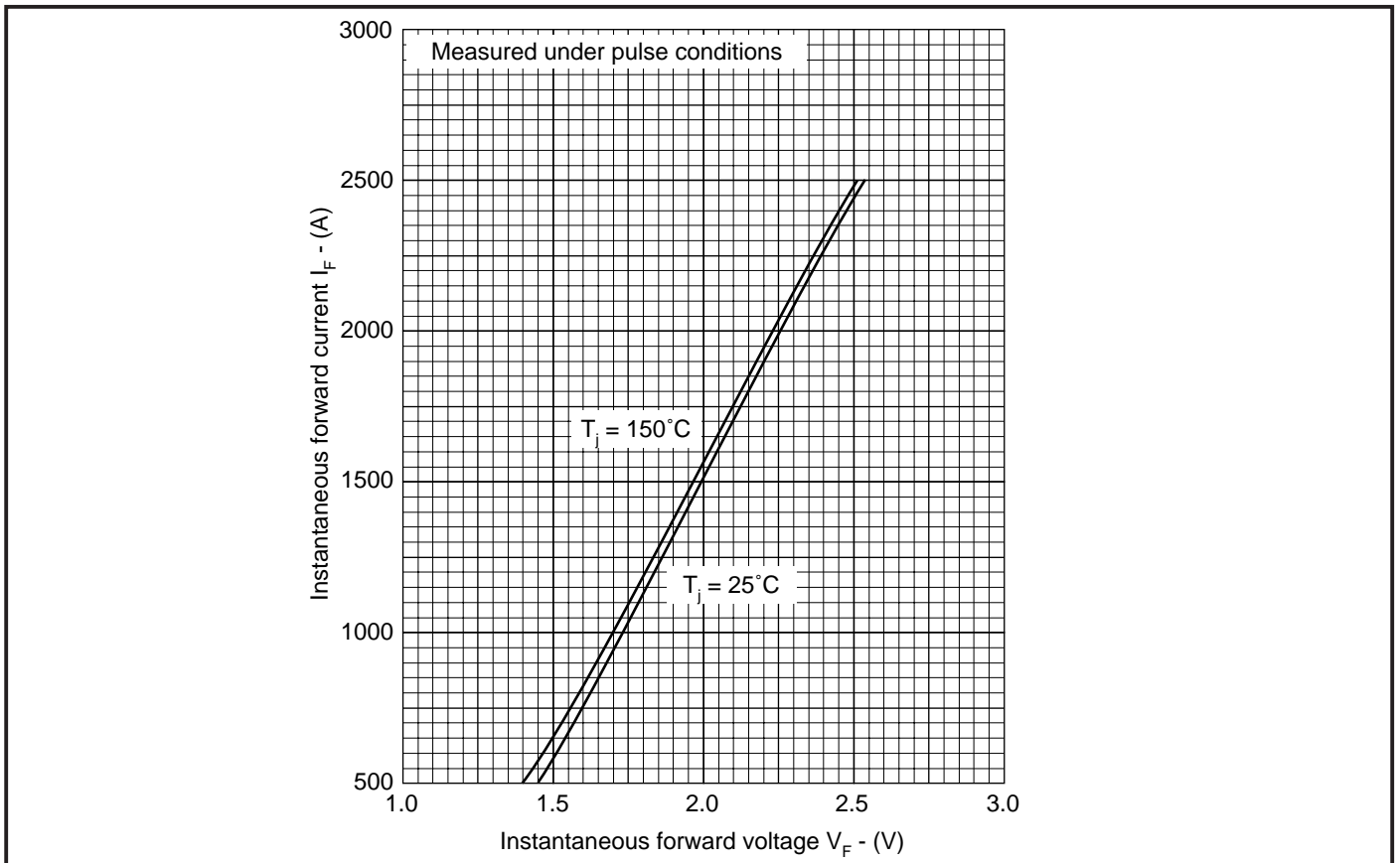

Fig.1 Maximum (limit) forward characteristics

TV22..F

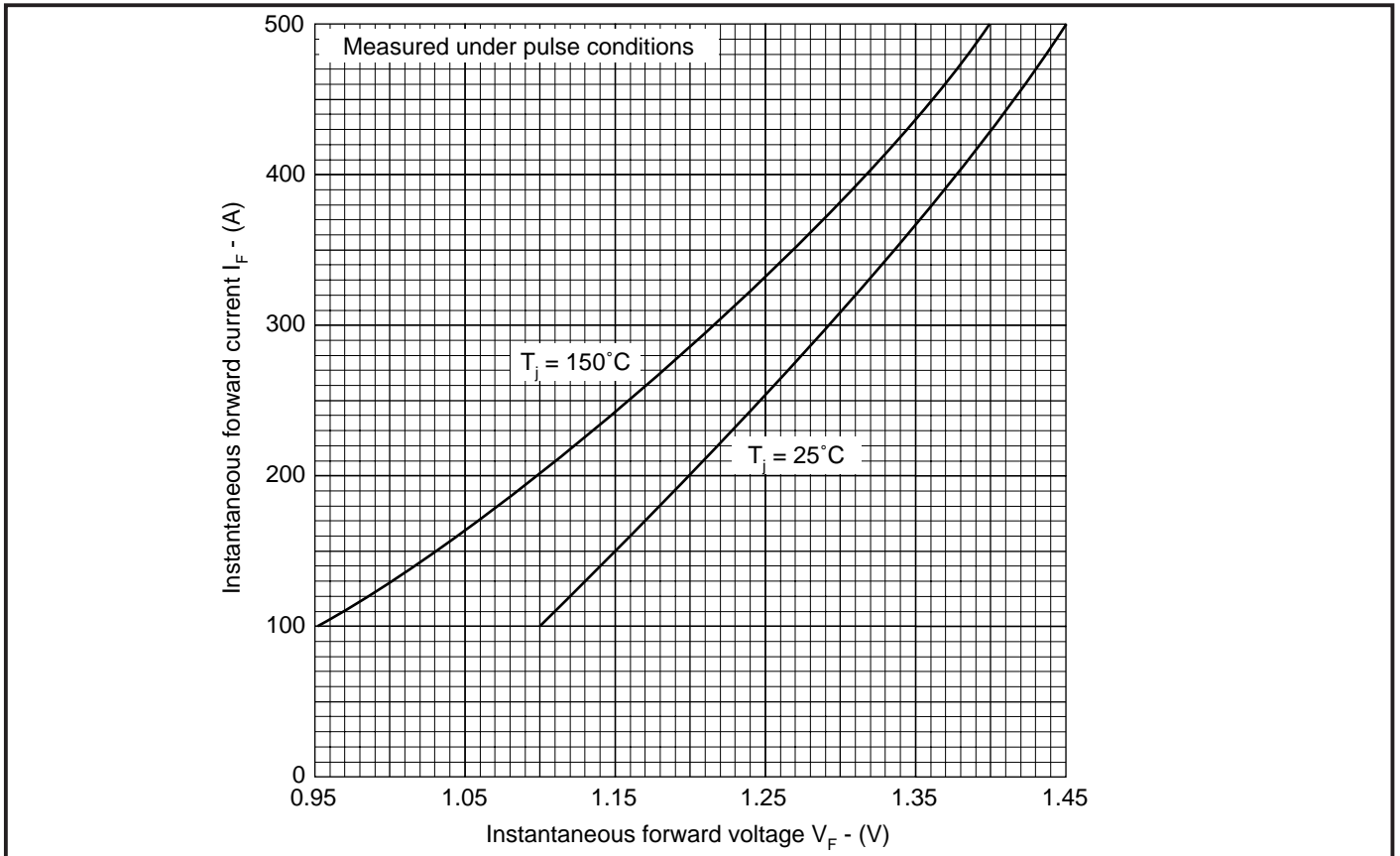

Fig.2 Maximum (limit) forward characteristics

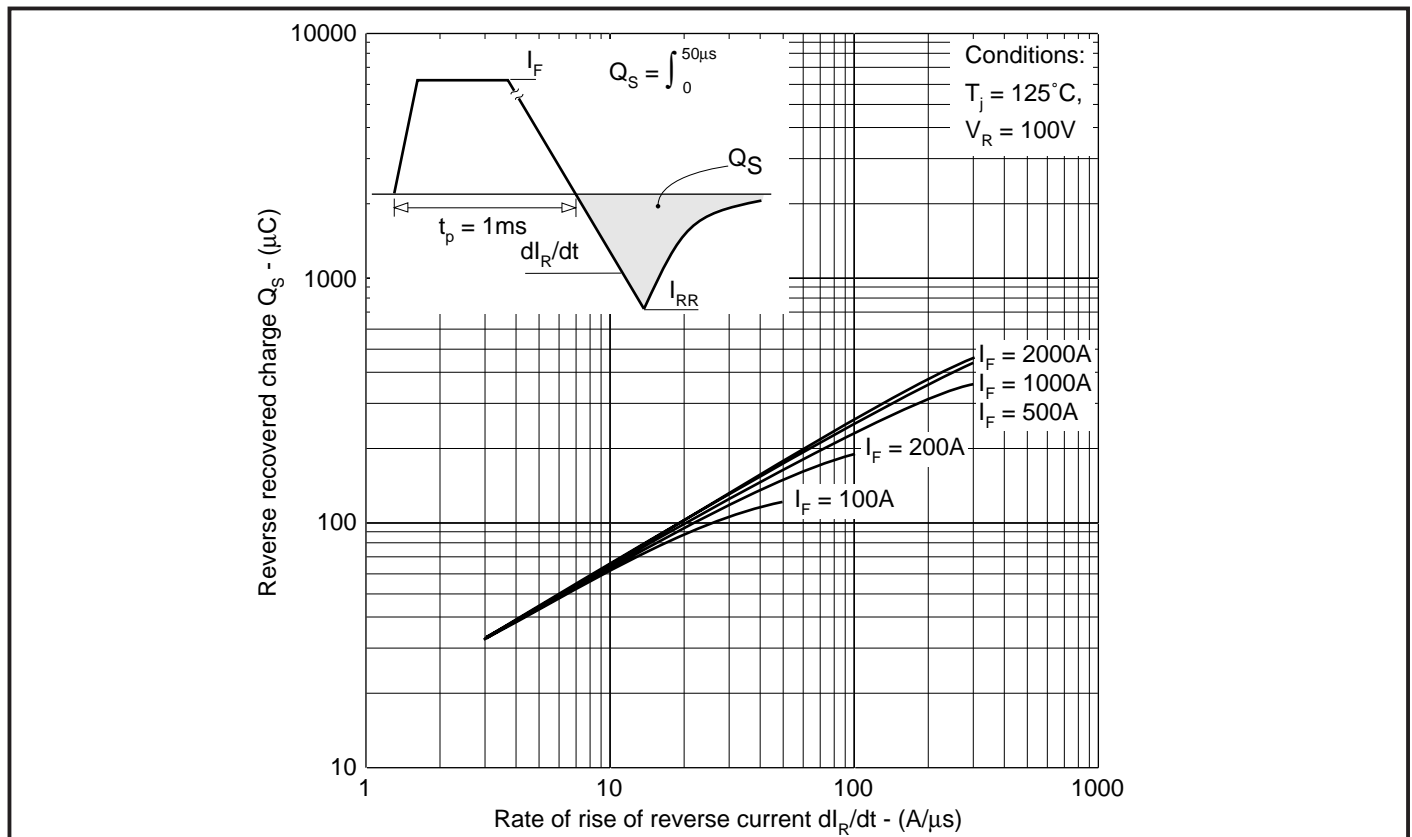

Fig.3 Recovered charge

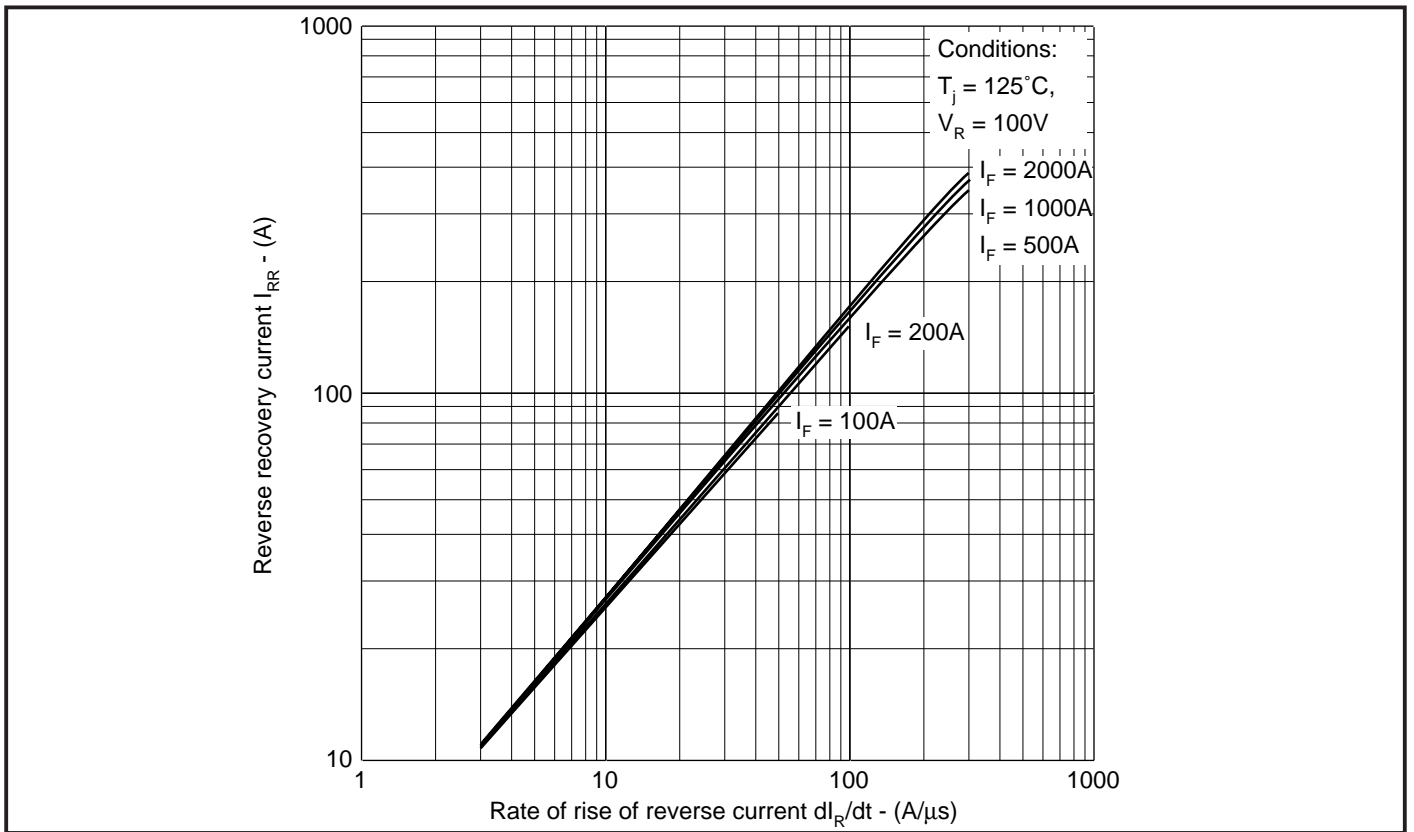

Fig.4 Typical reverse recovery current vs rate of rise of reverse current

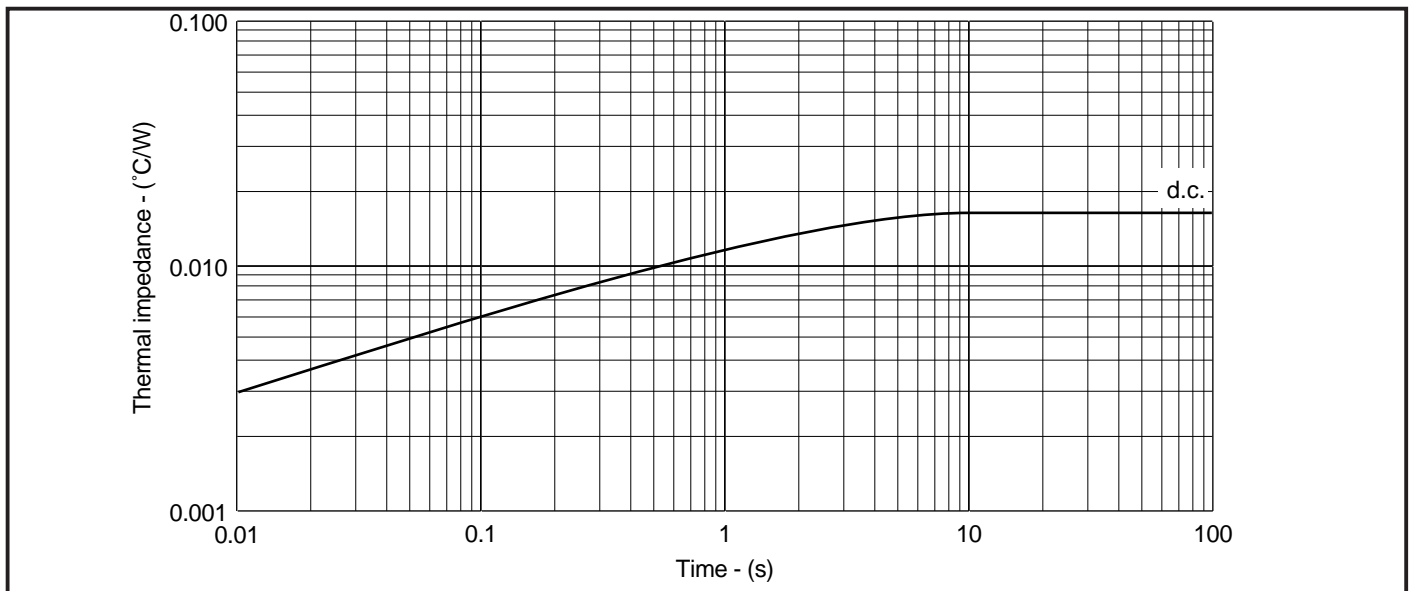
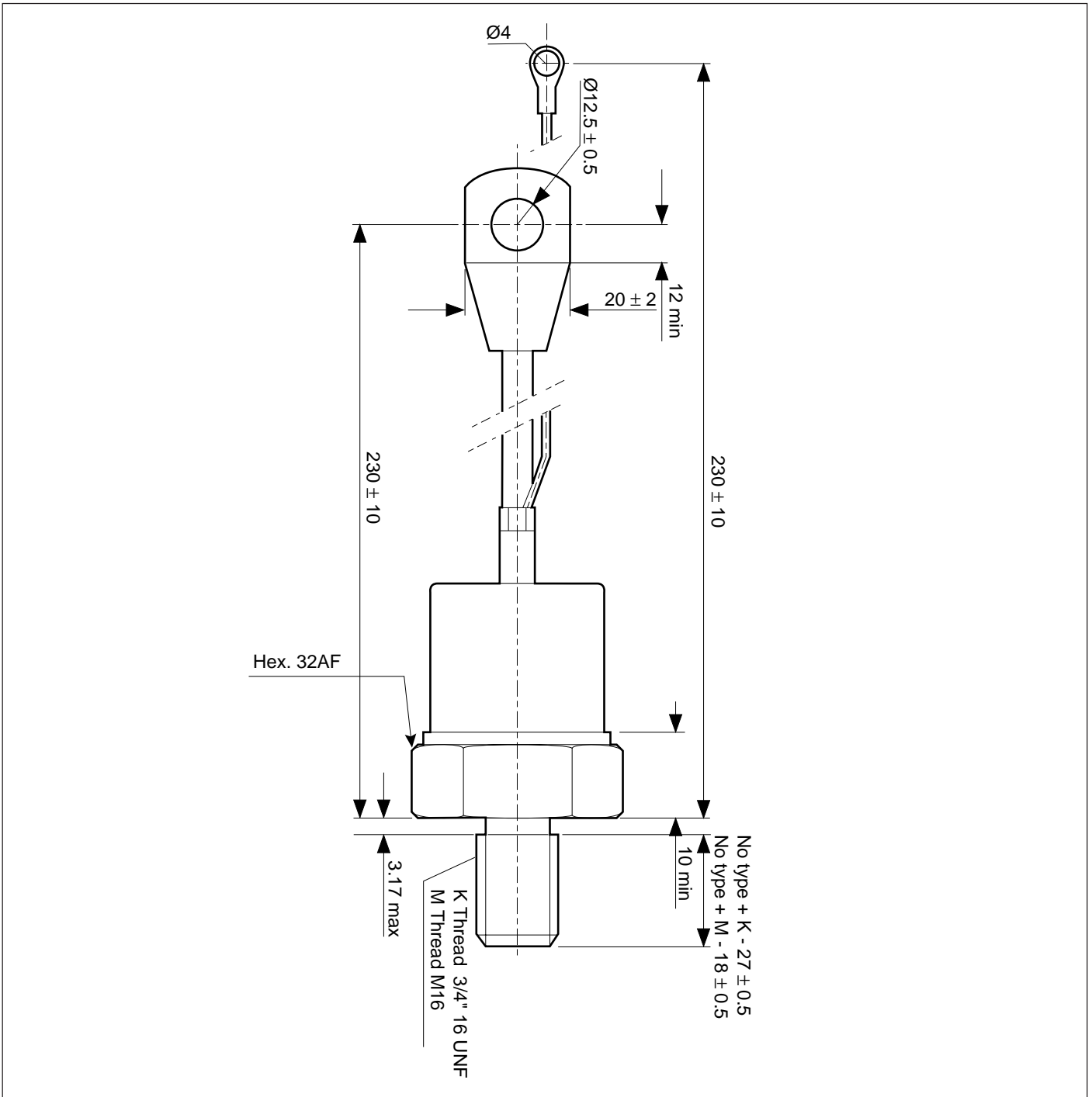

Fig.5 Maximum (limit) transient thermal impedance - junction to case - ($^\circ\text{C/W}$)

TV22..F

PACKAGE DETAILS

For further package information, please contact your local Customer Service Centre. All dimensions in mm, unless stated otherwise. DO NOT SCALE.



ASSOCIATED PUBLICATIONS

Title	Application Note Number
Calculating the junction temperature or power semiconductors	AN4506
Thyristor and diode measurement with a multi-meter	AN4853
Use of V_{TO} , r_T on-state characteristic	AN5001

POWER ASSEMBLY CAPABILITY

The Power Assembly group was set up to provide a support service for those customers requiring more than the basic semiconductor, and has developed a flexible range of heatsink / clamping systems in line with advances in device types and the voltage and current capability of our semiconductors.

We offer an extensive range of air and liquid cooled assemblies covering the full range of circuit designs in general use today. The Assembly group continues to offer high quality engineering support dedicated to designing new units to satisfy the growing needs of our customers.

Using the up to date CAD methods our team of design and applications engineers aim to provide the Power Assembly Complete solution (PACs).

HEATSINKS

Power Assembly has its own proprietary range of extruded aluminium heatsinks. They have been designed to optimise the performance of our semiconductors. Data with respect to air natural, forced air and liquid cooling (with flow rates) is available on request.

For further information on device clamps, heatsinks and assemblies, please contact your nearest Sales Representative or the factory.



<http://www.dynexsemi.com>

e-mail: power_solutions@dynexsemi.com

HEADQUARTERS OPERATIONS

DYNEX SEMICONDUCTOR LTD
Doddington Road, Lincoln.
Lincolnshire. LN6 3LF. United Kingdom.
Tel: 00-44-(0)1522-500500
Fax: 00-44-(0)1522-500550

DYNEX POWER INC.

Unit 7 - 58 Antares Drive,
Nepean, Ontario, Canada K2E 7W6.
Tel: 613.723.7035
Fax: 613.723.1518
Toll Free: 1.888.33.DYNEX (39639)

CUSTOMER SERVICE CENTRES

France, Benelux, Italy and Spain Tel: +33 (0)1 69 18 90 00. Fax: +33 (0)1 64 46 54 50
North America Tel: 011-800-5554-5554. Fax: 011-800-5444-5444
UK, Germany, Scandinavia & Rest Of World Tel: +44 (0)1522 500500. Fax: +44 (0)1522 500020

SALES OFFICES

France, Benelux, Italy and Spain Tel: +33 (0)1 69 18 90 00. Fax: +33 (0)1 64 46 54 50
Germany Tel: 07351 827723
North America Tel: (613) 723-7035. Fax: (613) 723-1518. Toll Free: 1.888.33.DYNEX (39639) /
Tel: (831) 440-1988. Fax: (831) 440-1989 / Tel: (949) 733-3005. Fax: (949) 733-2986.
UK, Germany, Scandinavia & Rest Of World Tel: +44 (0)1522 500500. Fax: +44 (0)1522 500020
These offices are supported by Representatives and Distributors in many countries world-wide.
© Dynex Semiconductor 2000 Publication No. DS4210-3 Issue No. 3.0 January 2000
TECHNICAL DOCUMENTATION – NOT FOR RESALE. PRINTED IN UNITED KINGDOM

Datasheet Annotations:

Dynex Semiconductor annotate datasheets in the top right hand corner of the front page, to indicate product status. The annotations are as follows:-

Target Information: This is the most tentative form of information and represents a very preliminary specification. No actual design work on the product has been started.

Preliminary Information: The product is in design and development. The datasheet represents the product as it is understood but details may change.

Advance Information: The product design is complete and final characterisation for volume production is well in hand.

No Annotation: The product parameters are fixed and the product is available to datasheet specification.

This publication is issued to provide information only which (unless agreed by the Company in writing) may not be used, applied or reproduced for any purpose nor form part of any order or contract nor to be regarded as a representation relating to the products or services concerned. No warranty or guarantee express or implied is made regarding the capability, performance or suitability of any product or service. The Company reserves the right to alter without prior notice the specification, design or price of any product or service. Information concerning possible methods of use is provided as a guide only and does not constitute any guarantee that such methods of use will be satisfactory in a specific piece of equipment. It is the user's responsibility to fully determine the performance and suitability of any equipment using such information and to ensure that any publication or data used is up to date and has not been superseded. These products are not suitable for use in any medical products whose failure to perform may result in significant injury or death to the user. All products and materials are sold and services provided subject to the Company's conditions of sale, which are available on request.

All brand names and product names used in this publication are trademarks, registered trademarks or trade names of their respective owners.