



RF Power Field Effect Transistors

N-Channel Enhancement-Mode Lateral MOSFETs

Designed for CDMA base station applications with frequencies from 2600 to 2700 MHz. Suitable for WiMAX, WiBro and multicarrier amplifier applications. To be used in Class AB and Class C for WLL applications.

- Typical Single-Carrier N-CDMA Performance: $V_{DD} = 28$ Volts, $I_{DQ} = 900$ mA, $P_{out} = 20$ Watts Avg., $f = 2660$ MHz, IS-95 CDMA (Pilot, Sync, Paging, Traffic Codes 8 Through 13), Channel Bandwidth = 1.2288 MHz, PAR = 9.8 dB @ 0.01% Probability on CCDF.
 Power Gain — 15.5 dB
 Drain Efficiency — 23.5%
 ACPR @ 885 kHz Offset — -48 dBc in 30 kHz Bandwidth
- Capable of Handling 10:1 VSWR, @ 28 Vdc, 2650 MHz, 85 Watts CW Output Power

Features

- Characterized with Series Equivalent Large-Signal Impedance Parameters
- Internally Matched for Ease of Use
- Qualified Up to a Maximum of 32 V_{DD} Operation
- Integrated ESD Protection
- Designed for Lower Memory Effects and Wide Instantaneous Bandwidth Applications
- RoHS Compliant
- In Tape and Reel. R3 Suffix = 250 Units per 56 mm, 13 inch Reel.

MRF6S27085HR3
MRF6S27085HSR3

2600-2700 MHz, 20 W AVG., 28 V
SINGLE N-CDMA
LATERAL N-CHANNEL
RF POWER MOSFETs

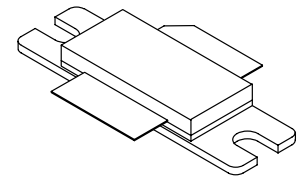

CASE 465-06, STYLE 1
NI-780
MRF6S27085HR3

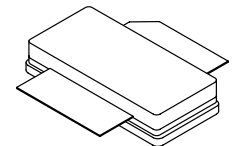

CASE 465A-06, STYLE 1
NI-780S
MRF6S27085HSR3

Table 1. Maximum Ratings

Rating	Symbol	Value	Unit
Drain-Source Voltage	V_{DSS}	-0.5, +68	Vdc
Gate-Source Voltage	V_{GS}	-0.5, +12	Vdc
Storage Temperature Range	T_{stg}	- 65 to +150	°C
Case Operating Temperature	T_C	150	°C
Operating Junction Temperature (1,2)	T_J	225	°C

Table 2. Thermal Characteristics

Characteristic	Symbol	Value (2,3)	Unit
Thermal Resistance, Junction to Case	$R_{\theta JC}$		°C/W
Case Temperature 80°C, 85 W CW		0.50	
Case Temperature 76°C, 20 W CW		0.56	

1. Continuous use at maximum temperature will affect MTTF.
2. MTTF calculator available at <http://www.freescale.com/rf>. Select Software & Tools/Development Tools/Calculators to access MTTF calculators by product.
3. Refer to AN1955, *Thermal Measurement Methodology of RF Power Amplifiers*. Go to <http://www.freescale.com/rf>. Select Documentation/Application Notes - AN1955.

Table 3. ESD Protection Characteristics

Test Methodology	Class
Human Body Model (per JESD22-A114)	3A (Minimum)
Machine Model (per EIA/JESD22-A115)	A (Minimum)
Charge Device Model (per JESD22-C101)	IV (Minimum)

Table 4. Electrical Characteristics ($T_C = 25^\circ\text{C}$ unless otherwise noted)

Characteristic	Symbol	Min	Typ	Max	Unit
----------------	--------	-----	-----	-----	------

Off Characteristics

Zero Gate Voltage Drain Leakage Current ($V_{DS} = 68\text{ Vdc}$, $V_{GS} = 0\text{ Vdc}$)	I_{DSS}	—	—	10	μAdc
Zero Gate Voltage Drain Leakage Current ($V_{DS} = 28\text{ Vdc}$, $V_{GS} = 0\text{ Vdc}$)	I_{DSS}	—	—	1	μAdc
Gate-Source Leakage Current ($V_{GS} = 5\text{ Vdc}$, $V_{DS} = 0\text{ Vdc}$)	I_{GSS}	—	—	1	μAdc

On Characteristics

Gate Threshold Voltage ($V_{DS} = 10\text{ Vdc}$, $I_D = 250\ \mu\text{Adc}$)	$V_{GS(th)}$	1	2	3	Vdc
Gate Quiescent Voltage ($V_{DD} = 28\text{ Vdc}$, $I_D = 900\ \text{mAdc}$, Measured in Functional Test)	$V_{GS(Q)}$	2	2.8	4	Vdc
Drain-Source On-Voltage ($V_{GS} = 10\text{ Vdc}$, $I_D = 2.2\ \text{Adc}$)	$V_{DS(on)}$	—	0.21	0.3	Vdc

Dynamic Characteristics ⁽¹⁾

Reverse Transfer Capacitance ($V_{DS} = 28\text{ Vdc} \pm 30\ \text{mV(rms)ac}$ @ 1 MHz, $V_{GS} = 0\text{ Vdc}$)	C_{rss}	—	2.8	—	pF
--	-----------	---	-----	---	----

Functional Tests (In Freescale Test Fixture, 50 ohm system) $V_{DD} = 28\text{ Vdc}$, $I_{DQ} = 900\ \text{mA}$, $P_{out} = 20\ \text{W Avg. N-CDMA}$, $f = 2660\ \text{MHz}$, Single-Carrier N-CDMA, 1.2288 MHz Channel Bandwidth Carrier. ACPR measured in 30 kHz Channel Bandwidth @ $\pm 885\ \text{kHz}$ Offset. PAR = 9.8 dB @ 0.01% Probability on CCDF.

Power Gain	G_{ps}	14	15.5	17	dB
Drain Efficiency	η_D	21	23.5	—	%
Adjacent Channel Power Ratio	ACPR	—	-48	-45	dBc
Input Return Loss	IRL	—	-13	-9	dB

1. Part is internally matched both on input and output.

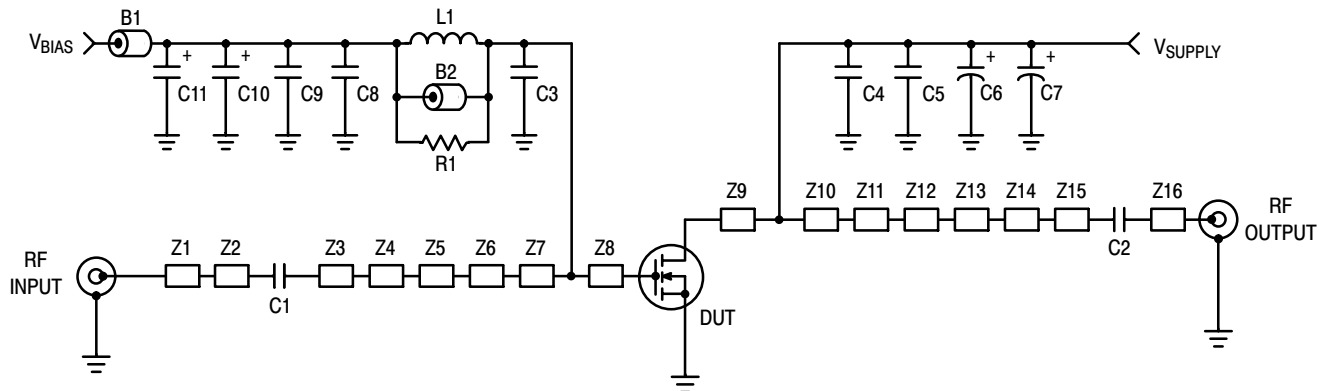

Z1	0.672" x 0.081" Microstrip	Z10	0.287" x 0.753" Microstrip
Z2	0.050" x 0.250" Microstrip	Z11	0.220" x 0.384" Microstrip
Z3	0.288" x 0.081" Microstrip	Z12	0.122" x 0.580" Microstrip
Z4	0.200" x 0.480" Microstrip	Z13	0.266" x 0.148" Microstrip
Z5	0.270" x 0.172" Microstrip	Z14	0.130" x 0.425" Microstrip
Z6	0.260" x 0.810" Microstrip	Z15	0.380" x 0.081" Microstrip
Z7	0.366" x 0.490" Microstrip	Z16	0.703" x 0.081" Microstrip
Z8	0.083" x 0.490" Microstrip	PCB	Arlon GX-0300-5022, 0.030", $\epsilon_r = 2.5$
Z9	0.091" x 0.753" Microstrip		

Figure 1. MRF6S27085HR3(SR3) Test Circuit Schematic

Table 5. MRF6S27085HR3(SR3) Test Circuit Component Designations and Values

Part	Description	Part Number	Manufacturer
B1	Ferrite Bead, Surface Mount	2508051107Y0	Fair-Rite
B2	Ferrite Bead, Surface Mount	2743019447	Fair-Rite
C1, C2	4.7 pF Chip Capacitors	ATC100B4R7CT500XT	ATC
C3	3.6 pF Chip Capacitor	ATC100B3R6CT500XT	ATC
C4	10 μ F, 50 V Chip Capacitor	GRM55DR61H106KA88B	Murata
C5, C8	2.2 μ F, 50 V Chip Capacitors	C1825C225J5RAC	Kemet
C6	47 μ F, 50 V Electrolytic Capacitor	EMVK500ADA470MF80G	United Chemi-Con
C7	330 μ F, 63 V Electrolytic Capacitor	EKMG630ELL331MJ20S	United Chemi-Con
C9	0.01 μ F Chip Capacitor	C1825C103J1RAC	Kemet
C10	22 μ F, 25 V Tantalum Capacitor	T491D226K025AT	Kemet
C11	47 μ F, 16 V Tantalum Capacitor	T491D476K016AT	Kemet
L1	15 nH, Chip Inductor	L0603150GGW	AVX
R1	3.3 Ω , 1/3 W Chip Resistor	CRCW12103R30FKEA	Vishay

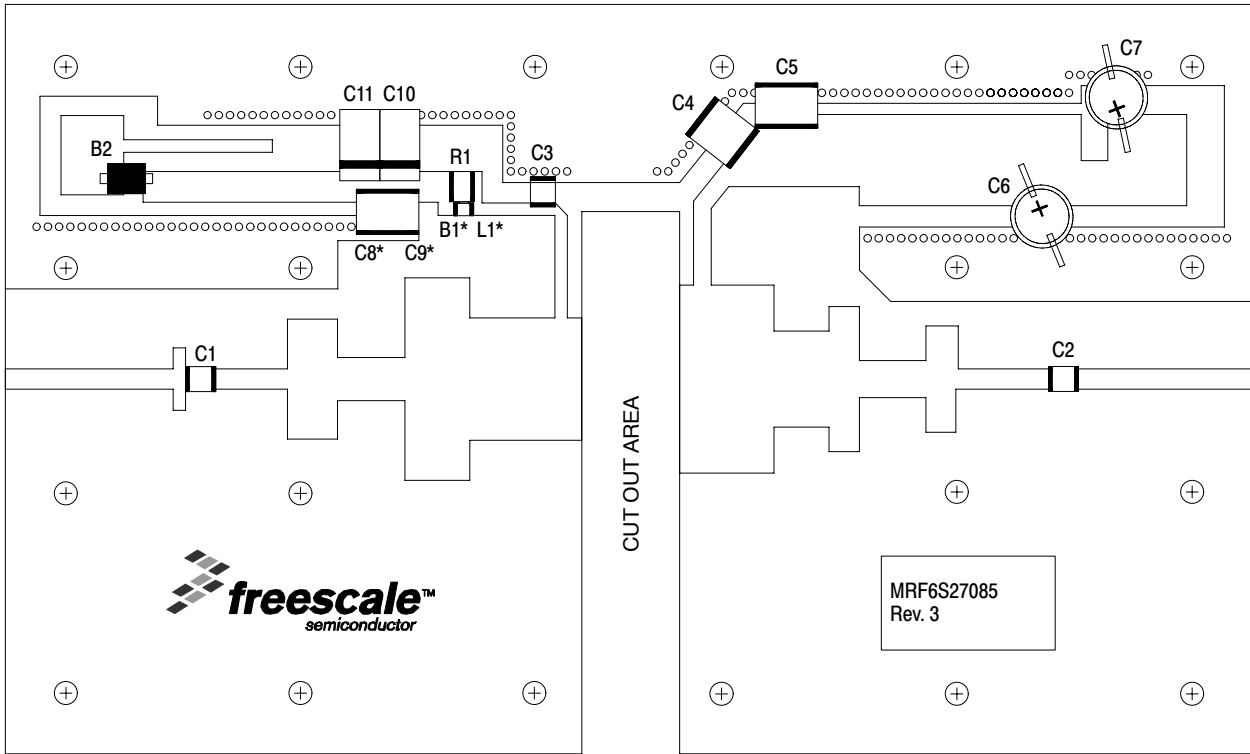

* Components stacked

Figure 2. MRF6S27085HR3(SR3) Test Circuit Component Layout

TYPICAL CHARACTERISTICS

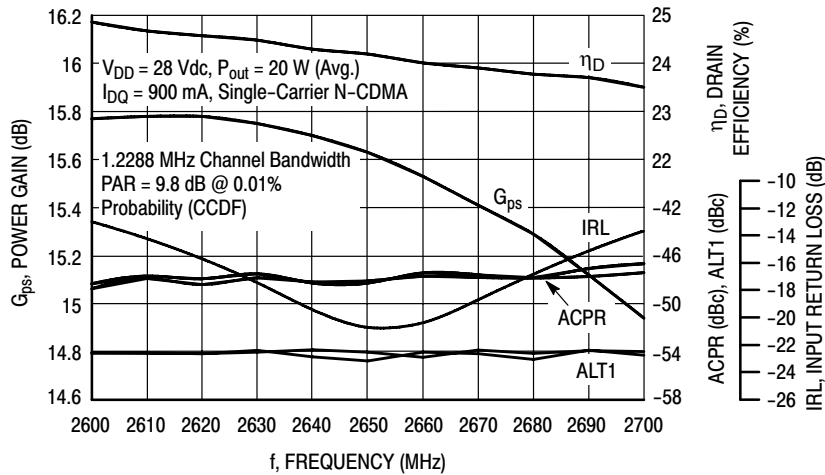

Figure 3. Single-Carrier N-CDMA Broadband Performance @ 20 Watts Avg.

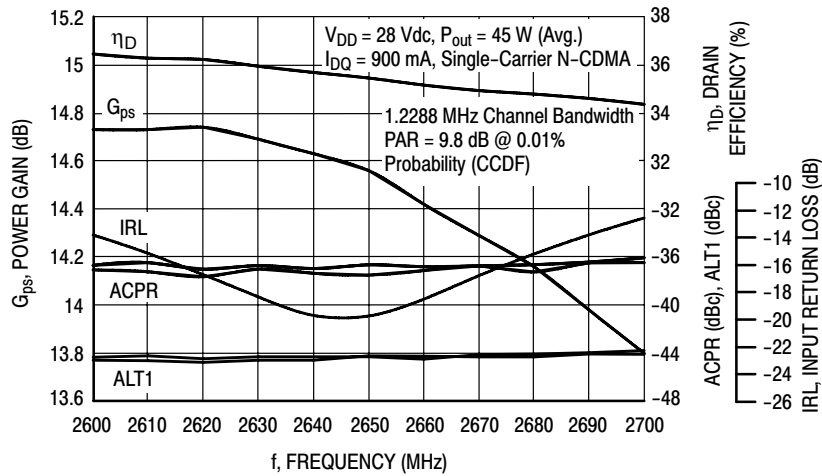

Figure 4. Single-Carrier N-CDMA Broadband Performance @ 45 Watts Avg.

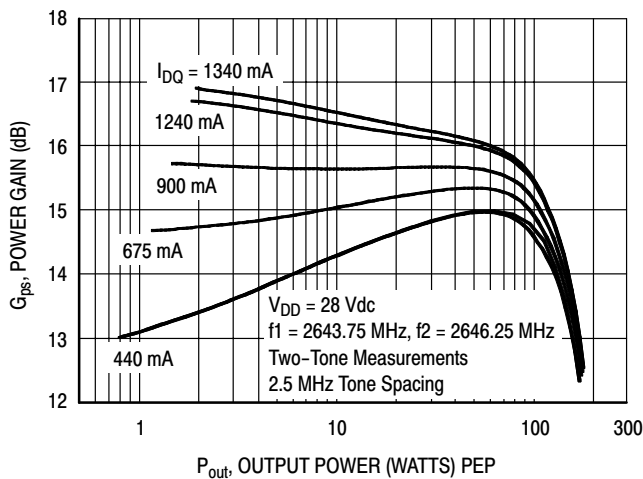

Figure 5. Two-Tone Power Gain versus Output Power

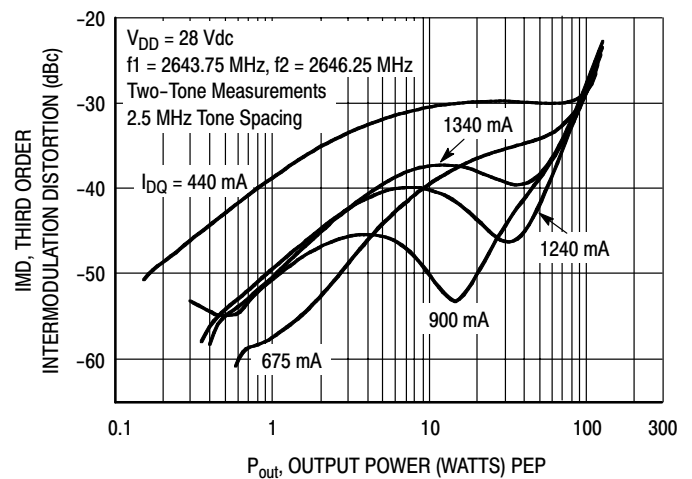

Figure 6. Third Order Intermodulation Distortion versus Output Power

TYPICAL CHARACTERISTICS

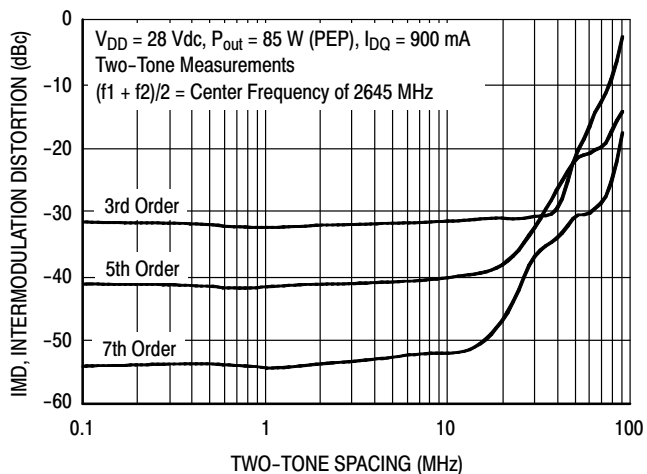

Figure 7. Intermodulation Distortion Products versus Tone Spacing

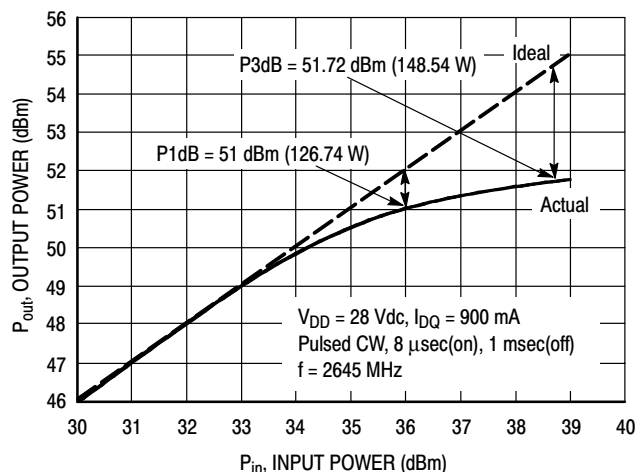

Figure 8. Pulsed CW Output Power versus Input Power

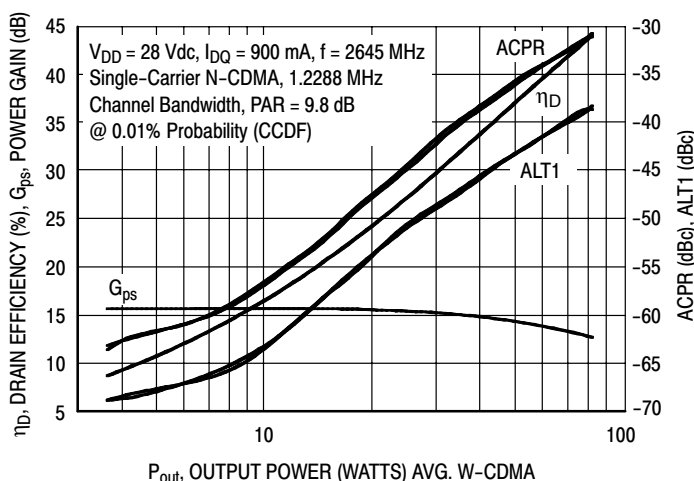

Figure 9. Single-Carrier N-CDMA ACPR, ALT1, Power Gain and Drain Efficiency versus Output Power

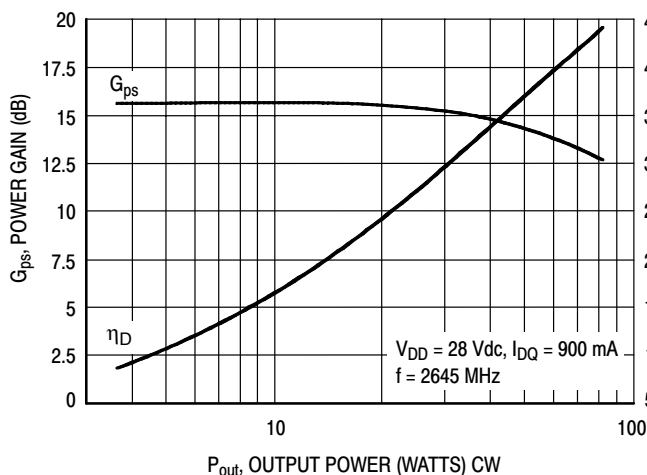

Figure 10. Power Gain and Drain Efficiency versus CW Output Power

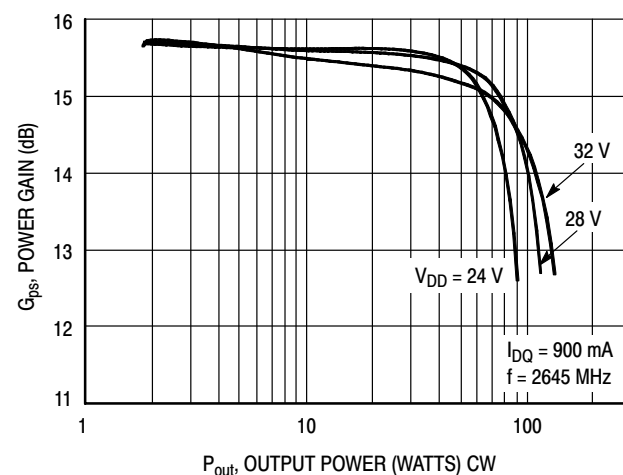
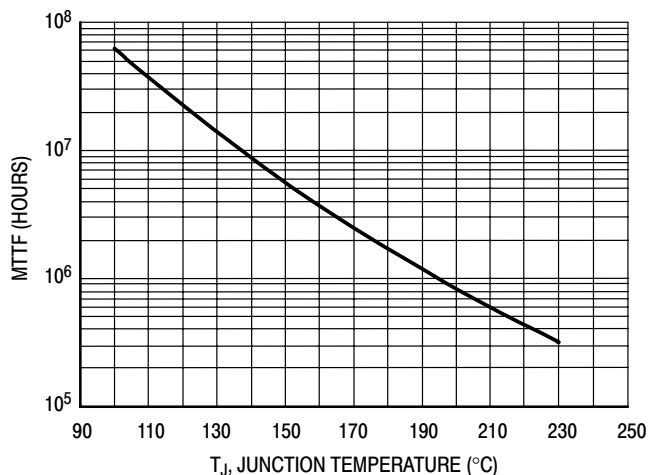

Figure 11. Power Gain versus Output Power

TYPICAL CHARACTERISTICS



This above graph displays calculated MTTF in hours when the device is operated at $V_{DD} = 28$ Vdc, $P_{out} = 20$ W Avg., and $\eta_D = 23.5\%$.

MTTF calculator available at <http://www.freescale.com/rf>. Select Software & Tools/Development Tools/Calculators to access MTTF calculators by product.

Figure 12. MTTF versus Junction Temperature

N-CDMA TEST SIGNAL

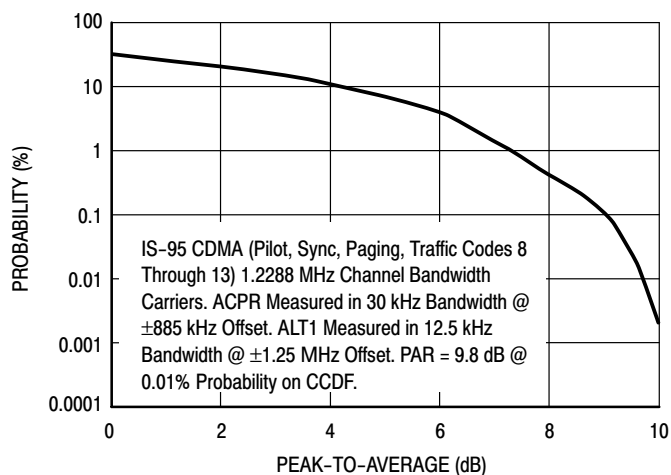

Figure 13. Single-Carrier CCDF N-CDMA

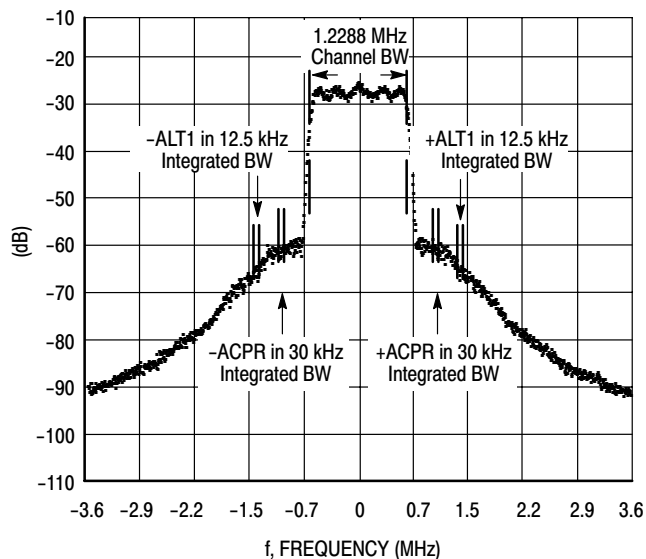
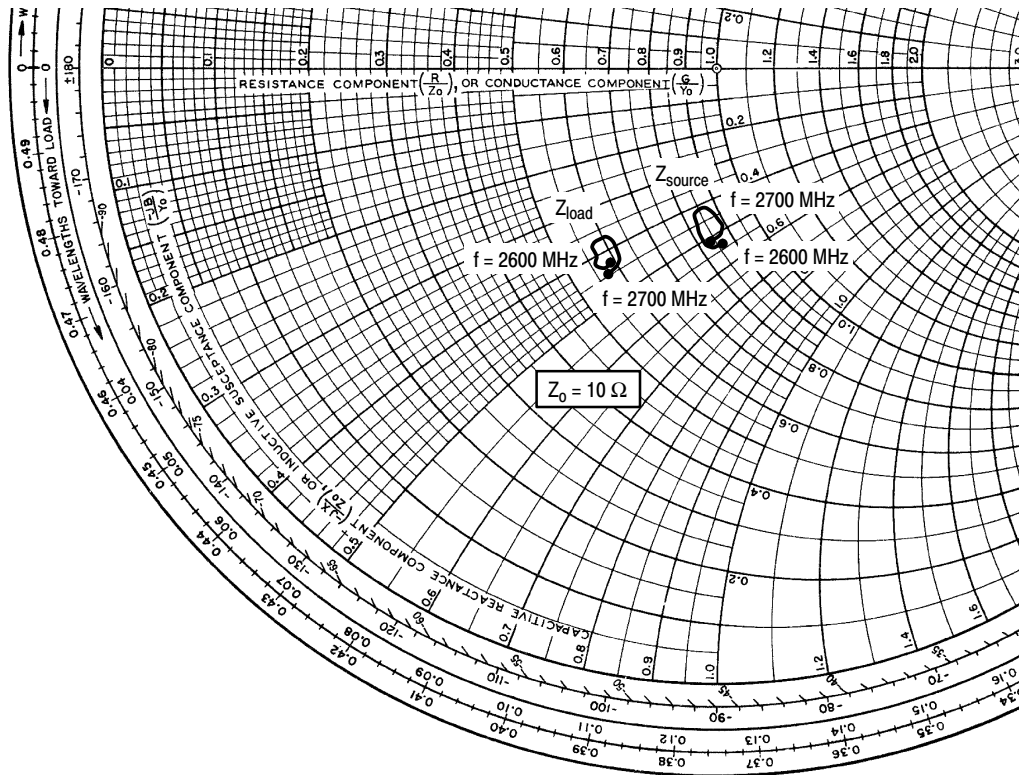

Figure 14. Single-Carrier N-CDMA Spectrum



$V_{DD} = 28 \text{ Vdc}$, $I_{DQ} = 900 \text{ mA}$, $P_{out} = 20 \text{ W Avg.}$

f MHz	Z_{source} Ω	Z_{load} Ω
2600	8.55 - j5.42	5.86 - j4.34
2610	8.31 - j5.30	5.69 - j4.26
2620	8.21 - j5.10	5.64 - j4.15
2630	8.21 - j4.85	5.67 - j4.00
2640	8.26 - j4.57	5.72 - j3.83
2645	8.40 - j4.43	5.80 - j3.75
2650	8.44 - j4.32	5.86 - j3.70
2660	8.78 - j4.29	6.10 - j3.72
2670	8.94 - j4.59	6.19 - j4.00
2680	8.88 - j5.01	6.07 - j4.36
2690	8.57 - j5.18	5.80 - j4.48
2700	8.36 - j5.10	5.71 - j4.47

Z_{source} = Test circuit impedance as measured from gate to ground.

Z_{load} = Test circuit impedance as measured from drain to ground.

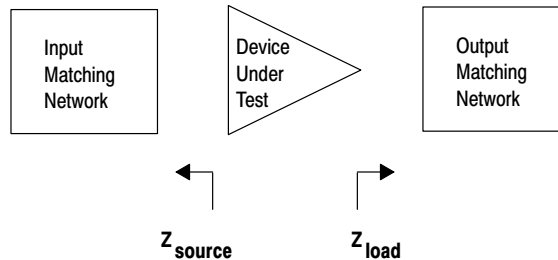
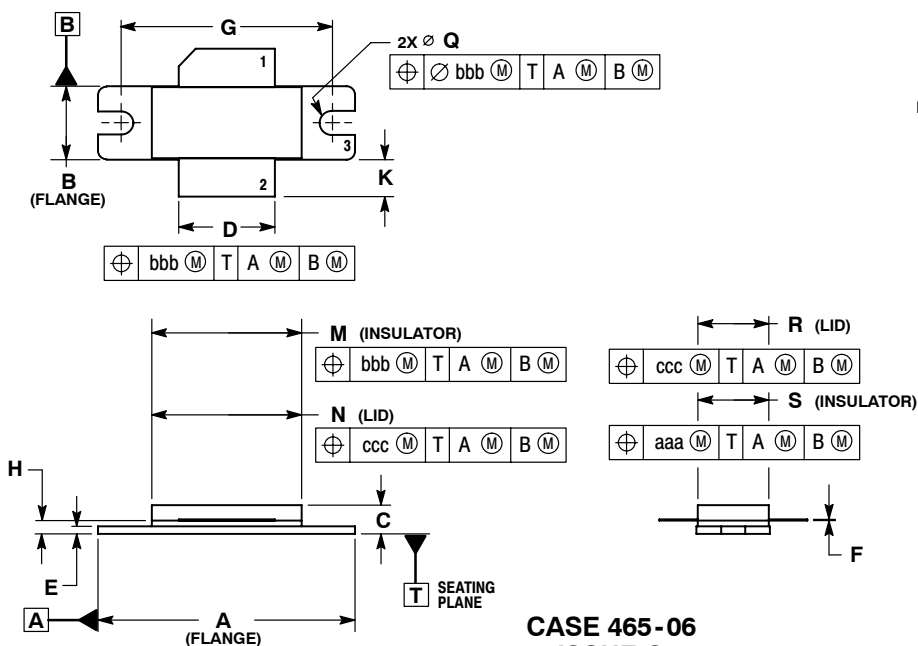

Figure 15. Series Equivalent Source and Load Impedance

PACKAGE DIMENSIONS



**CASE 465-06
ISSUE G
NI-780
MRF6S27085HR3**

- NOTES:
1. DIMENSIONING AND TOLERANCING PER ANSI Y14.5M-1994.
 2. CONTROLLING DIMENSION: INCH.
 3. DELETED
 4. DIMENSION H IS MEASURED 0.030 (0.762) AWAY FROM PACKAGE BODY.

DIM	INCHES		MILLIMETERS	
	MIN	MAX	MIN	MAX
A	1.335	1.345	33.91	34.16
B	0.380	0.390	9.65	9.91
C	0.125	0.170	3.18	4.32
D	0.495	0.505	12.57	12.83
E	0.035	0.045	0.89	1.14
F	0.003	0.006	0.08	0.15
G	1.100 BSC		27.94 BSC	
H	0.057	0.067	1.45	1.70
K	0.170	0.210	4.32	5.33
M	0.774	0.786	19.66	19.96
N	0.772	0.788	19.60	20.00
Q	Ø.118	Ø.138	Ø3.00	Ø3.51
R	0.365	0.375	9.27	9.53
S	0.365	0.375	9.27	9.52
aaa	0.005 REF		0.127 REF	
bbb	0.010 REF		0.254 REF	
ccc	0.015 REF		0.381 REF	

- STYLE 1:
PIN 1. DRAIN
2. GATE
3. SOURCE

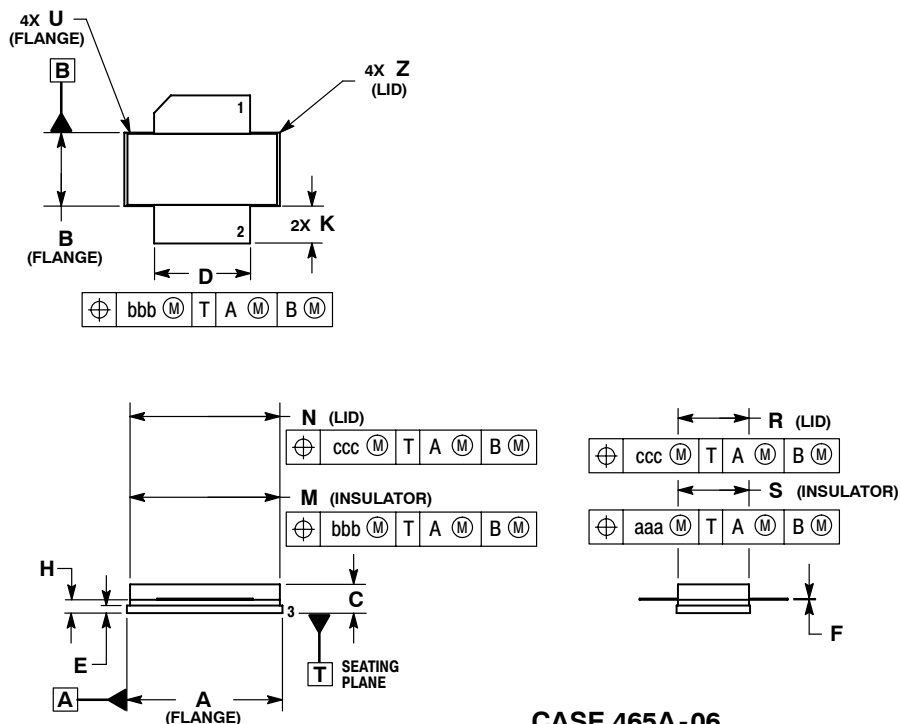

**CASE 465A-06
ISSUE H
NI-780S
MRF6S27085HSR3**

- NOTES:
1. DIMENSIONING AND TOLERANCING PER ANSI Y14.5M-1994.
 2. CONTROLLING DIMENSION: INCH.
 3. DELETED
 4. DIMENSION H IS MEASURED 0.030 (0.762) AWAY FROM PACKAGE BODY.

DIM	INCHES		MILLIMETERS	
	MIN	MAX	MIN	MAX
A	0.805	0.815	20.45	20.70
B	0.380	0.390	9.65	9.91
C	0.125	0.170	3.18	4.32
D	0.495	0.505	12.57	12.83
E	0.035	0.045	0.89	1.14
F	0.003	0.006	0.08	0.15
H	0.057	0.067	1.45	1.70
K	0.170	0.210	4.32	5.33
M	0.774	0.786	19.61	20.02
N	0.772	0.788	19.61	20.02
R	0.365	0.375	9.27	9.53
S	0.365	0.375	9.27	9.52
U	---	0.040	---	1.02
Z	---	0.030	---	0.76
aaa	0.005 REF		0.127 REF	
bbb	0.010 REF		0.254 REF	
ccc	0.015 REF		0.381 REF	

- STYLE 1:
PIN 1. DRAIN
2. GATE
5. SOURCE

PRODUCT DOCUMENTATION

Refer to the following documents to aid your design process.

Application Notes

- AN1955: Thermal Measurement Methodology of RF Power Amplifiers

Engineering Bulletins

- EB212: Using Data Sheet Impedances for RF LDMOS Devices

REVISION HISTORY

The following table summarizes revisions to this document.

Revision	Date	Description
3	Dec. 2008	<ul style="list-style-type: none">• Modified data sheet to reflect RF Test Reduction described in Product and Process Change Notification number, PCN13232, p. 1, 2• Removed Lower Thermal Resistance and Low Gold Plating bullets from Features section as functionality is standard, p. 1• Removed Total Device Dissipation from Max Ratings table as data was redundant (information already provided in Thermal Characteristics table), p. 1• Operating Junction Temperature increased from 200°C to 225°C in Maximum Ratings table and related "Continuous use at maximum temperature will affect MTTF" footnote added, p. 1• Corrected V_{DS} to V_{DD} in the RF test condition voltage callout for $V_{GS(Q)}$, and added "Measured in Functional Test", On Characteristics table, p. 2• Removed Forward Transconductance from On Characteristics table as it no longer provided usable information, p. 2• Changed minimum drain efficiency specification from 22% to 21% to match production test limits, Table 4, Functional Tests, p. 2• Updated Part Numbers in Table 5, Component Designations and Values, to RoHS compliant part numbers, p. 3• Removed lower voltage tests from Fig. 11, Power Gain versus Output Power, due to fixed tuned fixture limitations, p. 6• Replaced Fig. 12, MTTF versus Junction Temperature, with updated graph. Removed Amps² and listed operating characteristics and location of MTTF calculator for device, p. 7• Added Product Documentation and Revision History, p. 10

How to Reach Us:

Home Page:

www.freescale.com

Web Support:

<http://www.freescale.com/support>

USA/Europe or Locations Not Listed:

Freescale Semiconductor, Inc.
Technical Information Center, EL516
2100 East Elliot Road
Tempe, Arizona 85284
1-800-521-6274 or +1-480-768-2130
www.freescale.com/support

Europe, Middle East, and Africa:

Freescale Halbleiter Deutschland GmbH
Technical Information Center
Schatzbogen 7
81829 Muenchen, Germany
+44 1296 380 456 (English)
+46 8 52200080 (English)
+49 89 92103 559 (German)
+33 1 69 35 48 48 (French)
www.freescale.com/support

Japan:

Freescale Semiconductor Japan Ltd.
Headquarters
ARCO Tower 15F
1-8-1, Shimo-Meguro, Meguro-ku,
Tokyo 153-0064
Japan
0120 191014 or +81 3 5437 9125
support.japan@freescale.com

Asia/Pacific:

Freescale Semiconductor China Ltd.
Exchange Building 23F
No. 118 Jianguo Road
Chaoyang District
Beijing 100022
China
+86 10 5879 8000
support.asia@freescale.com

For Literature Requests Only:

Freescale Semiconductor Literature Distribution Center
P.O. Box 5405
Denver, Colorado 80217
1-800-441-2447 or +1-303-675-2140
Fax: +1-303-675-2150
LDCForFreescaleSemiconductor@hibbertgroup.com

Information in this document is provided solely to enable system and software implementers to use Freescale Semiconductor products. There are no express or implied copyright licenses granted hereunder to design or fabricate any integrated circuits or integrated circuits based on the information in this document.

Freescale Semiconductor reserves the right to make changes without further notice to any products herein. Freescale Semiconductor makes no warranty, representation or guarantee regarding the suitability of its products for any particular purpose, nor does Freescale Semiconductor assume any liability arising out of the application or use of any product or circuit, and specifically disclaims any and all liability, including without limitation consequential or incidental damages. "Typical" parameters that may be provided in Freescale Semiconductor data sheets and/or specifications can and do vary in different applications and actual performance may vary over time. All operating parameters, including "Typicals", must be validated for each customer application by customer's technical experts. Freescale Semiconductor does not convey any license under its patent rights nor the rights of others. Freescale Semiconductor products are not designed, intended, or authorized for use as components in systems intended for surgical implant into the body, or other applications intended to support or sustain life, or for any other application in which the failure of the Freescale Semiconductor product could create a situation where personal injury or death may occur. Should Buyer purchase or use Freescale Semiconductor products for any such unintended or unauthorized application, Buyer shall indemnify and hold Freescale Semiconductor and its officers, employees, subsidiaries, affiliates, and distributors harmless against all claims, costs, damages, and expenses, and reasonable attorney fees arising out of, directly or indirectly, any claim of personal injury or death associated with such unintended or unauthorized use, even if such claim alleges that Freescale Semiconductor was negligent regarding the design or manufacture of the part.

Freescale™ and the Freescale logo are trademarks of Freescale Semiconductor, Inc. All other product or service names are the property of their respective owners.

© Freescale Semiconductor, Inc. 2005-2006, 2008. All rights reserved.

