

SURFACE MOUNT ALUMINUM ELECTROLYTIC CAPACITORS

67	CA Series	2,000 hrs. at 85°C
74	CB Series	1,000 hrs. at 105°C
81	CE Series	2,000 hrs. at 105°C



REEL DIMENSIONS

Unit : mm

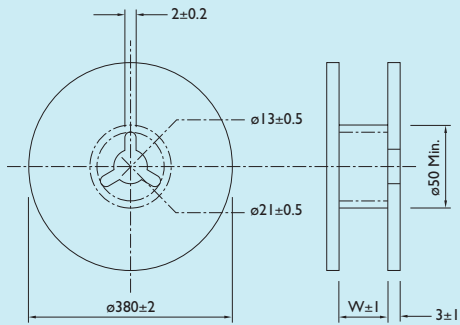

SIZE CODE	A	B	C	D	E	F	G
W	14	14	14	18	18	26	26

TAPING DIMENSIONS

Unit : mm

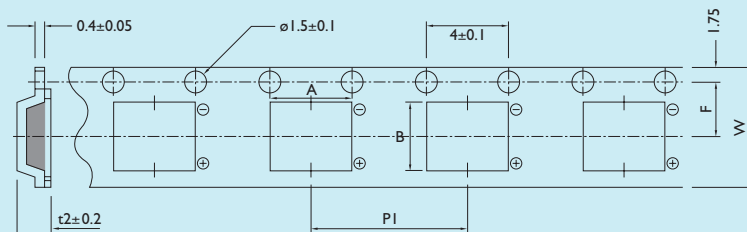

CASE SIZE	(ØD mm)	W	A	B	P1	F	t2
A	Ø3	12.0	3.4	3.5	8.0	5.5	5.8
B	Ø4	12.0	4.7	4.6	8.0	5.5	5.8
C	Ø5	12.0	5.7	5.7	12.0	5.5	5.8
D	Ø6.3	16.0	7.0	7.0	12.0	7.5	5.8
E	Ø8 x 6.2	16.0	8.7	8.7	12.0	7.5	6.8
F	Ø8 x 10.2	24.0	8.7	8.7	16.0	11.5	11.0
G	Ø10 x 10.2	24.0	10.7	10.7	16.0	11.5	11.0

PACKAGING QUANTITY

CASE SIZE	ØD	INNER PACKAGING (PCS/REEL)	OUTER PACKAGING (PCS/BOX)
A	Ø3	2000	20000
B	Ø4	2000	20000
C	Ø5	1000	10000
D	Ø6.3	1000	10000
E	Ø8 x 6.2	1000	10000
F	Ø8 x 10.2	500	3000
G	Ø10 x 10.2	500	3000

REEL DIMENSIONS

Unit : mm

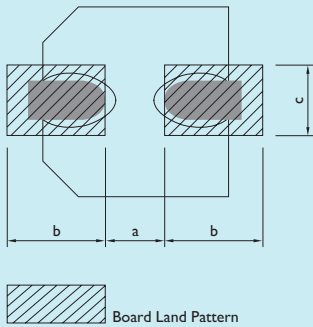

SIZE CODE	a	b	c
A (Ø3)	0.6	2.2	1.5
B (Ø4)	1.0	2.5	1.6
C (Ø5)	1.5	2.8	1.6
D (Ø6.3)	1.8	3.2	1.6
E (Ø8 x 6.2)	2.2	4.0	1.6
F (Ø8 x 10.2)	3.1	4.0	2.0
G (Ø10 x 10.2)	4.6	4.1	2.0

REFLOW SOLDERING TEMPERATURE PROFILE

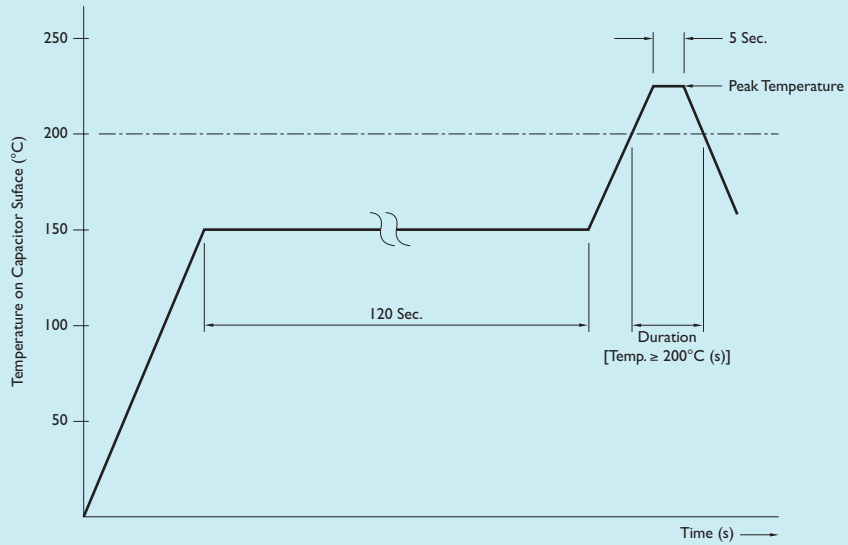

Peak Temperature / Duration [Temp. ≥ 200°C (s)]

Peak Temperature / Duration [Temp. ≥ 200°C (s)]

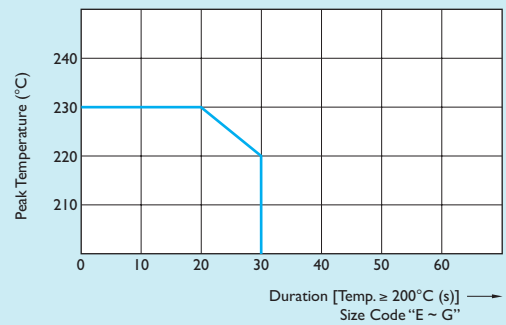
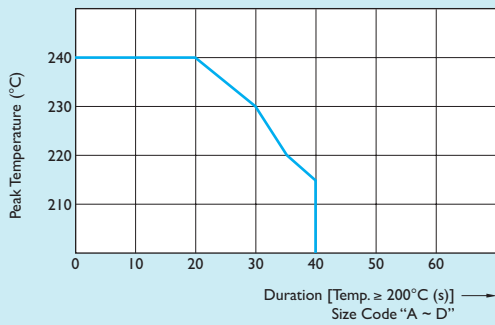

Surface Mount Aluminum Electrolytic

CA Series



FEATURE

For General Purposes Series with 85°C 2000 Hours

Suitable for AV (TV, Video, Audio), Personal Computer, Home Appliance

MARKING

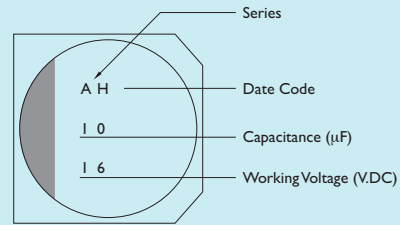

DIMENSIONS

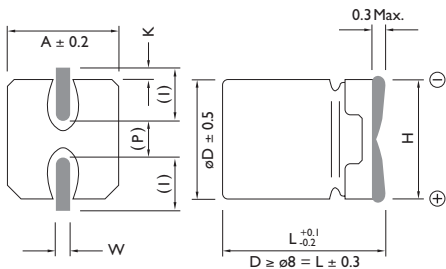

() Reference Size

Unit : mm

SIZE CODE	DØ	L	A	H	I	W	P	K
A	3.0	5.4	3.3	4.5 Max.	1.5	0.55 ± 0.1	0.6	0.35 ^{+0.15} _{-0.20}
B	4.0	5.4	4.3	5.5 Max.	1.8	0.65 ± 0.1	1.0	0.35 ^{+0.15} _{-0.20}
C	5.0	5.4	5.3	6.5 Max.	2.2	0.65 ± 0.1	1.5	0.35 ^{+0.15} _{-0.20}
D	6.3	5.4	6.6	7.8 Max.	2.6	0.65 ± 0.1	2.2	0.35 ^{+0.15} _{-0.20}
E	8.0	6.2	8.3	9.4 Max.	3.4	0.65 ± 0.1	2.2	0.35 ^{+0.15} _{-0.20}
F	8.0	10.2	8.3	10.0 Max.	3.4	0.90 ± 0.2	3.1	0.70 ± 0.20
G	10.0	10.2	10.3	12.0 Max.	3.5	0.90 ± 0.2	4.6	0.70 ± 0.20



PARTS NUMBER SYSTEM

Example : 10 μ F, 16V

CA	016	M	0010	R	E	B	-	0405
Series Name	Voltage Code	Tolerance	Capacitance Code	Package Code	Life Code	Size Code		Case Code

CAPACITANCE TOLERANCE

M	$\pm 20\%$
K	$\pm 10\%$
W	-5% ~ +20%

LIFE CODE

E	2000 Hours
S	1000 Hours
R	Special

SIZE CODE

Size Code	A	B	C	D	E	F	G
D \varnothing (mm)	3.0 x 5.4	4.0 x 5.4	5.0 x 5.4	6.3 x 5.4	8.0 x 6.2	8.0 x 10.2	10.0 x 10.2

CAPACITANCE CODE

Capacitance	0.1	0.22	0.33	0.47	1.0	2.2	3.3	4.7	6.8	10	22	33	47	100	220	330	470	1000
Code	0R10	0R22	0R33	0R47	1R00	2R20	3R30	4R70	6R80	0010	0022	0033	0047	0100	0220	0330	0470	1000

VOLTAGE CODE

Voltage	4	6.3	10	16	25	35	50	63	100
Code	004	006	010	016	025	035	050	063	100

PACKAGE CODE

R Embossed Plastic Tape Reel

CASE CODE

0305	3.0 x 5.4	0405	4.0 x 5.4	05.5	5.0 x 5.4	0605	6.3 x 5.4
0806	8.0 x 6.2	0810	8.0 x 10.2	1010	10.0 x 10.2		

Unit : mm

STANDARD PRODUCTS

WV (VD.C)	CAP. (μ F)	SIZE (mm)		PART NO.	D.F Max. 120 Hz	LEAKAGE CURRENT (μ A/2 Min.) Max.	RIPPLE CURRENT (mA) r.m.s. 120 Hz / 85°C
		DØ	L				
4	22	3	5.4	CA004M0022REA-0305	0.37	3.0	19
	33	4	5.4	CA004M0033REB-0405	0.35	3.0	26
	47	4	5.4	CA004M0047REB-0405	0.35	3.0	34
	100	5	5.4	CA004M0100REC-0505	0.35	4.0	61
	220	6.3	5.4	CA004M0220RED-0605	0.35	8.8	82
6.3	22	3	5.4	CA006M0022REA-0305	0.37	3.0	20
	22	4	5.4	CA006M0022REB-0405	0.26	3.0	29
	33	4	5.4	CA006M0033REB-0405	0.35	3.0	22
	33	5	5.4	CA006M0033REC-0505	0.26	3.0	29
	47	5	5.4	CA006M0047REC-0505	0.26	3.0	46
	100	6.3	5.4	CA006M0100RED-0605	0.26	6.3	71
	330	8	6.2	CA006M0330REE-0806	0.35	20.8	300
	470	8	10.0	CA006M0470REF-0810	0.35	29.6	380
	1000	10	10.0	CA006M1000REG-1010	0.35	63.0	700
10	22	4	5.4	CA010M0022REB-0405	0.20	3.0	28
	33	4	5.4	CA010M0033REB-0405	0.30	3.3	29
	33	5	5.4	CA010M0033REC-0505	0.20	3.3	43
	47	5	5.4	CA010M0047REC-0505	0.30	4.7	43
	47	6.3	5.4	CA010M0047RED-0605	0.20	4.7	43
	100	6.3	5.4	CA010M0100RED-0605	0.20	10.0	70
	220	8	6.2	CA010M0220REE-0806	0.26	22.0	250
	330	8	10.0	CA010M0330REF-0810	0.26	33.0	330
	470	8	10.0	CA010M0470REF-0810	0.26	47.0	330
	470	10	10.0	CA010M0470REG-1010	0.26	47.0	400
	1000	10	10.0	CA010M1000REG-1010	0.26	100.0	580
16	6.8	4	5.4	CA016M6R80REB-0405	0.16	3.0	25
	10	3	5.4	CA016M0010REA-0305	0.18	3.0	20
	10	4	5.4	CA016M0010REB-0405	0.16	3.0	28
	22	4	5.4	CA016M0022REB-0405	0.26	3.5	28
	22	5	5.4	CA016M0022REC-0505	0.16	3.5	39
	33	5	5.4	CA016M0033REC-0505	0.16	5.3	35
	47	5	5.4	CA016M0047REC-0505	0.26	7.5	39
	47	6.3	5.4	CA016M0047RED-0605	0.16	7.5	70
	100	6.3	5.4	CA016M0100RED-0605	0.26	16.0	70
	100	8	6.2	CA016M0100REE-0806	0.20	16.0	200
	220	8	10.2	CA016M0220REF-0810	0.20	35.2	280
	330	8	10.2	CA016M0330REF-0810	0.20	52.8	320
	330	10	10.2	CA016M0330REG-1010	0.20	52.8	380
	470	10	10.2	CA016M0470REG-1010	0.20	75.2	420
25	4.7	3	5.4	CA025M4R70REA-0305	0.16	3.0	12
	4.7	4	5.4	CA025M4R70REB-0405	0.14	3.0	22
	10	4	5.4	CA025M0010REB-0405	0.14	3.0	21
	10	5	5.4	CA025M0010REC-0505	0.14	3.0	28
	22	6.3	5.4	CA025M0022RED-0605	0.14	5.5	55
	33	6.3	5.4	CA025M0033RED-0605	0.14	8.3	65
	47	6.3	5.4	CA025M0047RED-0605	0.16	11.8	80



STANDARD PRODUCTS

WV (VD.C)	CAP. (μ F)	SIZE (mm)		PART NO.	D.F Max. 120 Hz	LEAKAGE CURRENT (μ A/2 Min.) Max.	RIPPLE CURRENT (mA) r.m.s. 120 Hz / 85°C
		DØ	L				
25	100	8	6.2	CA025M0100REE-0806	0.16	25.0	91
	100	8	10.0	CA025M0100REF-0810	0.16	25.0	180
	220	8	10.0	CA025M0220REF-0810	0.16	55.0	140
	220	10	10.0	CA025M0220REG-1010	0.16	55.0	310
	330	10	10.0	CA025M0330REG-1010	0.16	82.5	340
35	2.2	3	5.4	CA035M2R20REA-0305	0.14	3.0	8
	3.3	3	5.4	CA035M3R30REA-0305	0.14	3.0	10
	4.7	4	5.4	CA035M4R70REB-0405	0.12	3.0	22
	10	5	5.4	CA035M0010REC-0505	0.12	3.5	30
	22	6.3	5.4	CA035M0022RED-0605	0.12	7.7	60
	33	6.3	5.4	CA035M0033RED-0605	0.14	11.6	70
	33	8	6.2	CA035M0033REE-0806	0.14	11.6	130
	47	8	6.2	CA035M0047REE-0806	0.14	16.5	165
	100	8	10.0	CA035M0100REF-0810	0.14	35.0	140
	100	10	10.0	CA035M0100REG-1010	0.14	35.0	210
	220	10	10.0	CA035M0220REG-1010	0.14	77.0	310
50	0.1	3	5.4	CA050M0R10REA-0305	0.14	3.0	1
	0.1	4	5.4	CA050M0R10REB-0405	0.12	3.0	1
	0.22	3	5.4	CA050M0R22REA-0305	0.14	3.0	2
	0.22	4	5.4	CA050M0R22REB-0405	0.12	3.0	2
	0.33	3	5.4	CA050M0R33REA-0305	0.14	3.0	3
	0.33	4	5.4	CA050M0R33REB-0405	0.12	3.0	3
	0.47	3	5.4	CA050M0R47REA-0305	0.14	3.0	5
	0.47	4	5.4	CA050M0R47REB-0405	0.12	3.0	5
	1	3	5.4	CA050M1R00REA-0305	0.14	3.0	8
	1	4	5.4	CA050M1R00REB-0405	0.12	3.0	10
	2.2	4	5.4	CA050M2R20REB-0405	0.12	3.0	16
	3.3	4	5.4	CA050M3R30REB-0405	0.12	3.0	16
	4.7	4	5.4	CA050M4R70REC-0505	0.12	3.0	23
	10	6.3	5.4	CA050M0010RED-0605	0.12	5.0	35
	22	6.3	5.4	CA050M0022RED-0605	0.12	11.0	70
	22	8	6.2	CA050M0022REE-0806	0.12	11.0	120
	33	8	6.2	CA050M0033REE-0806	0.12	16.5	65
	33	8	10.0	CA050M0033REF-0810	0.12	16.5	110
	47	8	10.0	CA050M0047REF-0810	0.12	23.5	110
	47	10	10.0	CA050M0047REG-1010	0.12	23.5	130
100	10	10.0	CA050M0100REG-1010	0.12	50.0	250	
63	10	8	6.2	CA063M0010REE-0806	0.18	6.3	35
	22	8	10.0	CA063M0022REF-0810	0.18	13.9	40
	33	8	10.0	CA063M0033REF-0810	0.18	20.8	45
	100	10	10.0	CA063M0100REG-1010	0.18	63.0	60
100	3.3	8	6.2	CA100M3R30REE-0806	0.18	3.3	50
	4.7	8	10.2	CA100M4R70REF-0810	0.18	4.7	80
	10	8	10.2	CA100M0010REF-0810	0.18	10.0	85
	22	10	10.2	CA100M0022REG-1010	0.18	22.0	85
	33	10	10.2	CA100M0033REG-1010	0.18	33.0	90

Note : Extended capacitance and voltage values as well as miniaturized products are available on request.

TEMPERATURE CHARACTERISTICS DATA

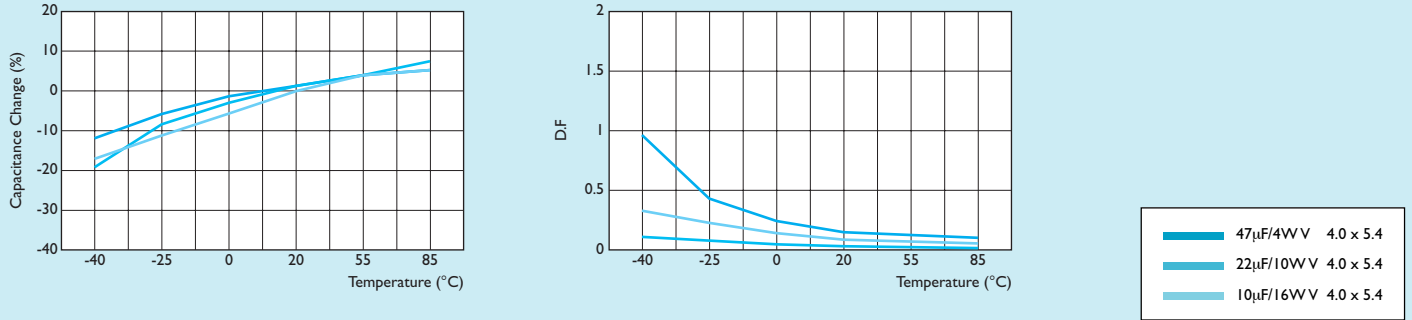

LOAD LIFE DATA

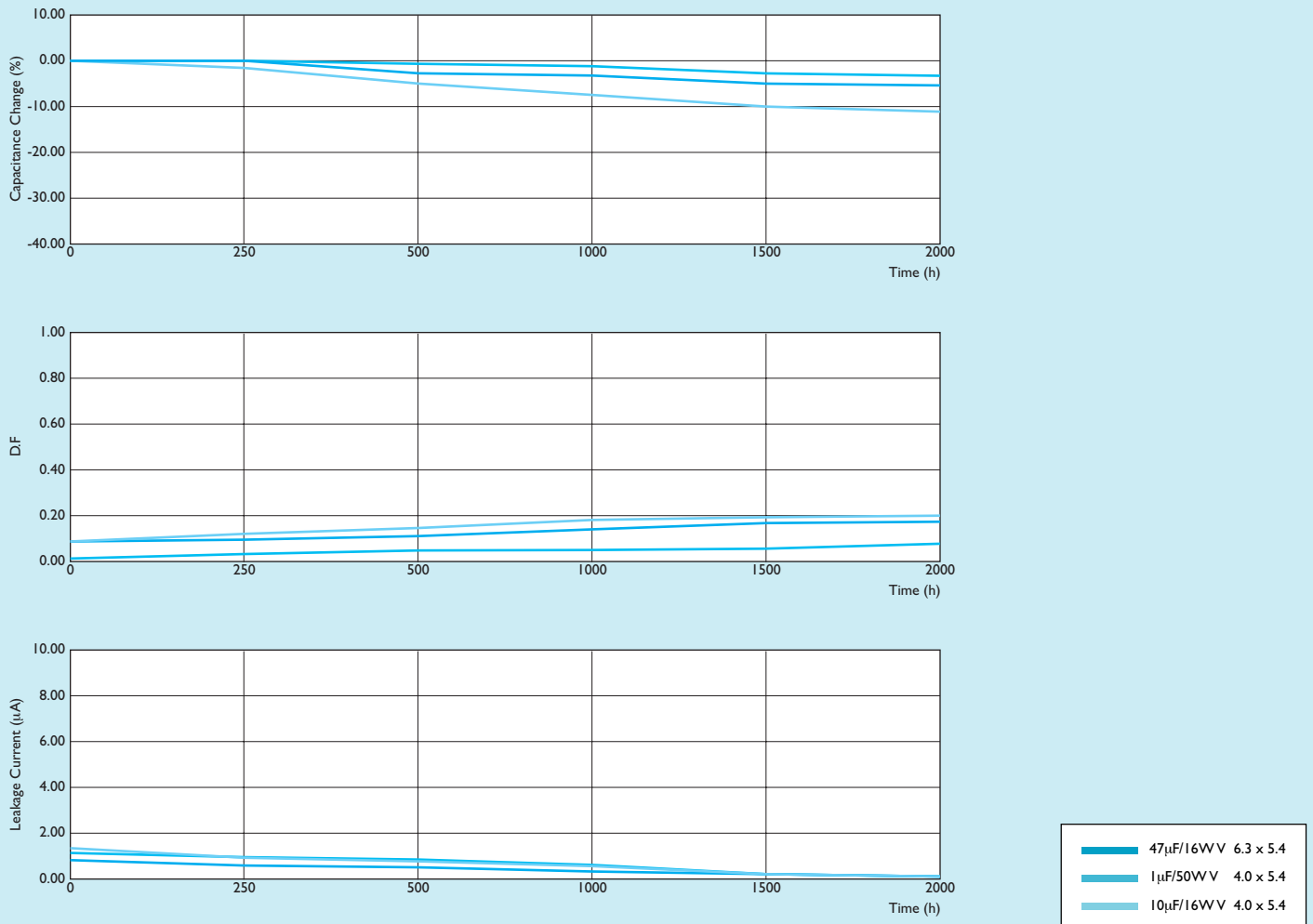



FREQUENCY CHARACTERISTICS DATA

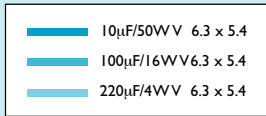
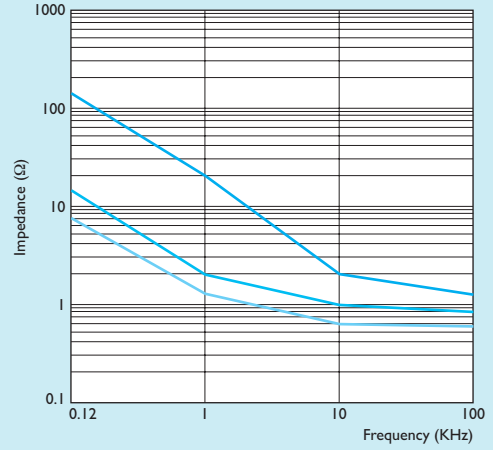
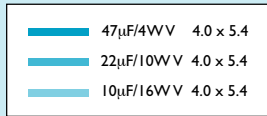
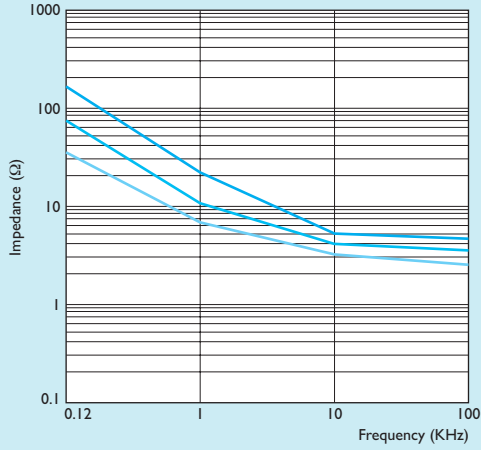

TEMPERATURE CHARACTERISTICS DATA

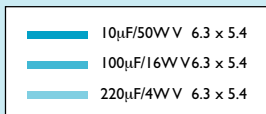
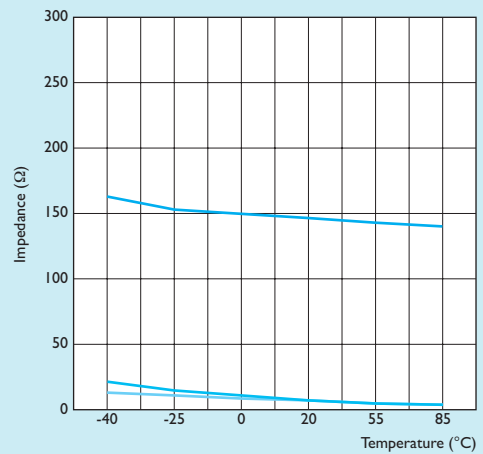
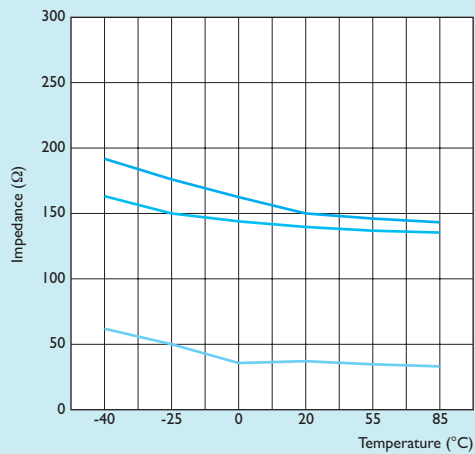

CB Series

Surface Mount
Aluminum Electrolytic

FEATURE

For General Purposes Series with 105°C 1000 Hours

Suitable for AV (TV, Video, Audio), Personal Computer, Home Appliance

MARKING

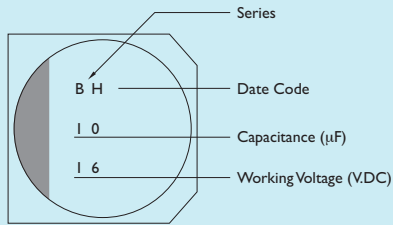

DIMENSIONS

SIZE CODE	DØ	L	A	H	I	W	P	K
B	4.0	5.4	4.3	5.5 Max.	1.8	0.65 ± 0.1	1.0	0.35 $^{+0.15}_{-0.20}$
C	5.0	5.4	5.3	6.5 Max.	2.2	0.65 ± 0.1	1.5	0.35 $^{+0.15}_{-0.20}$
D	6.3	5.4	6.6	7.8 Max.	2.6	0.65 ± 0.1	2.2	0.35 $^{+0.15}_{-0.20}$
E	8.0	6.2	8.3	9.5 Max.	3.4	0.65 ± 0.1	2.2	0.35 $^{+0.15}_{-0.20}$
F	8.0	10.2	8.3	10.0 Max.	3.4	0.90 ± 0.2	3.1	0.70 ± 0.20
G	10.0	10.2	10.3	12.0 Max.	3.5	0.90 ± 0.2	4.6	0.70 ± 0.20

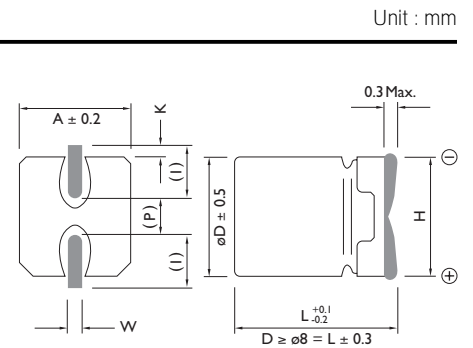



SPECIFICATION

ITEM	CHARACTERISTIC																											
Operation Temperature Range	-40 to +105°C																											
Rated Working Voltage Range	6.3 to 100V. DC																											
Capacitance Tolerance	±20% (120Hz / +25°C)																											
Leakage Current (25°C)	Polarized : $I \leq 0.01CV$ or 3 (μA) Whichever is greater after 2 minutes application of DC rated working voltage at 25°C. I : Leakage Current (μA) C : Rated Capacitance (μF) V : Working Voltage (V)																											
Dissipation Factor (tan δ) (120Hz / +25°C)	Polarized () : D.F of Downsized <table border="1"> <thead> <tr> <th>WV (V)</th> <th>6.3</th> <th>10</th> <th>16</th> <th>25</th> <th>35</th> <th>50</th> <th>63</th> <th>100</th> </tr> </thead> <tbody> <tr> <td>D.F $\varnothing 4 \sim \varnothing 6.3$</td> <td>0.30 (0.35)</td> <td>0.22 (0.30)</td> <td>0.16 (0.26)</td> <td>0.14 (0.18)</td> <td>0.12 (0.14)</td> <td>0.12</td> <td>0.12</td> <td>0.12</td> </tr> <tr> <td> $\varnothing 8 \sim \varnothing 10$</td> <td>0.35</td> <td>0.26</td> <td>0.20</td> <td>0.16</td> <td>0.14</td> <td>0.12</td> <td>0.18</td> <td>0.18</td> </tr> </tbody> </table>	WV (V)	6.3	10	16	25	35	50	63	100	D.F $\varnothing 4 \sim \varnothing 6.3$	0.30 (0.35)	0.22 (0.30)	0.16 (0.26)	0.14 (0.18)	0.12 (0.14)	0.12	0.12	0.12	$\varnothing 8 \sim \varnothing 10$	0.35	0.26	0.20	0.16	0.14	0.12	0.18	0.18
WV (V)	6.3	10	16	25	35	50	63	100																				
D.F $\varnothing 4 \sim \varnothing 6.3$	0.30 (0.35)	0.22 (0.30)	0.16 (0.26)	0.14 (0.18)	0.12 (0.14)	0.12	0.12	0.12																				
$\varnothing 8 \sim \varnothing 10$	0.35	0.26	0.20	0.16	0.14	0.12	0.18	0.18																				
Low Temperature Stability	Impedance Ratio at 120Hz <table border="1"> <thead> <tr> <th>WV (V)</th> <th>6.3</th> <th>10</th> <th>16</th> <th>25</th> <th>35</th> <th>50</th> <th>63</th> <th>100</th> </tr> </thead> <tbody> <tr> <td>-25 / +20°C</td> <td>4</td> <td>3</td> <td>2</td> <td>2</td> <td>2</td> <td>2</td> <td>3</td> <td>3</td> </tr> <tr> <td>-40 / +20°C</td> <td>8</td> <td>6</td> <td>4</td> <td>4</td> <td>3</td> <td>3</td> <td>4</td> <td>4</td> </tr> </tbody> </table>	WV (V)	6.3	10	16	25	35	50	63	100	-25 / +20°C	4	3	2	2	2	2	3	3	-40 / +20°C	8	6	4	4	3	3	4	4
WV (V)	6.3	10	16	25	35	50	63	100																				
-25 / +20°C	4	3	2	2	2	2	3	3																				
-40 / +20°C	8	6	4	4	3	3	4	4																				
Load Life	After 1000 hours application of WV at 105°C, the capacitor shall meet following limits. Capacitance Change $\leq \pm 20\%$ of Initial Value Dissipation Factor $\leq 200\%$ of Initial Specified Value Leakage Current \leq Initial Specified Value																											
Shelf Life	At +105°C no voltage application after 1000 hours and then through the aging treatment, the capacitor shall meet limits for load life characteristics.																											

CASE SIZE & MAX RIPPLE CURRENT

Max. Ripple Current (mA) r.m.s. (120Hz / +105°C)

POLARIZED																
μF	CODE	V (CODE)														
		6.3 (006)	10 (010)	16 (016)	25 (025)	35 (035)	50 (050)	63 (063)	100 (100)							
0.1	0R10								4.0 x 5.4	1						
0.22	0R22								4.0 x 5.4	2						
0.33	0R33								4.0 x 5.4	3						
0.47	0R47								4.0 x 5.4	5						
1.0	1R00								4.0 x 5.4	10						
2.2	2R20								4.0 x 5.4	16						
3.3	3R30								4.0 x 5.4	16					8.0 x 6.2	30
4.7	4R70				4.0 x 5.4	22	4.0 x 5.4	22	5.0 x 5.4	23				8.0 x 10.2	50	
10	0010			4.0 x 5.4	28	4.0 x 5.4	25	5.0 x 5.4	30	6.3 x 5.4	35	8.0 x 6.2	25	8.0 x 10.2	55	
					5.0 x 5.4	28										
22	0022	4.0 x 5.4	29		5.0 x 5.4	39	6.3 x 5.4	55	6.3 x 5.4	60	8.0 x 6.2	70	8.0 x 10.2	30	10 x 10.2	60
33	0033			5.0 x 5.4	43		6.3 x 5.4	65	8.0 x 6.2	84	8.0 x 10.2	91	10 x 10.2	45	10 x 10.2	65
47	0047	5.0 x 5.4	46		6.3 x 5.4	70	6.3 x 5.4	80	8.0 x 10.2	98	10 x 10.2	100	10 x 10.2	50		
					8.0 x 6.2	91										
100	0100	6.3 x 5.4	71	6.3 x 5.4	70	6.3 x 5.4	100	8.0 x 10.2	130	10 x 10.2	160	10 x 10.2	120			
				8.0 x 6.2	110											
220	0220			8.0 x 10.2	160	10 x 10.2	210	10 x 10.2	190	10 x 10.2	210					
330	0330	8.0 x 10.2	230		10 x 10.2	230	10 x 10.2	340								
470	0470			8.0 x 10.2	270	10 x 10.2	340									
															Size	R.C

PARTS NUMBER SYSTEM

Example : 10 μ F, 16V

CB	016	M	0010	R	S	B	-	0405
Series Name	Voltage Code	Tolerance	Capacitance Code	Package Code	Life Code	Size Code		Case Code

CAPACITANCE TOLERANCE

M	$\pm 20\%$
K	$\pm 10\%$
W	-5% ~ +20%

LIFE CODE

E	2000 Hours
S	1000 Hours
R	Special

SIZE CODE

Size Code	A	B	C	D	E	F	G
D \varnothing (mm)	3.0 x 5.4	4.0 x 5.4	5.0 x 5.4	6.3 x 5.4	8.0 x 6.2	8.0 x 10.2	10.0 x 10.2

CAPACITANCE CODE

Capacitance	0.1	0.22	0.33	0.47	1.0	2.2	3.3	4.7	10	22	33	47	100	220	330	470
Code	0R10	0R22	0R33	0R47	1R00	2R20	3R30	4R70	0010	0022	0033	0047	0100	0220	0330	0470

VOLTAGE CODE

Voltage	6.3	10	16	25	35	50	63	100
Code	006	010	016	025	035	050	063	100

PACKAGE CODE

R	Embossed Plastic Tape Reel
---	----------------------------

CASE CODE

0305	3.0 x 5.4	0405	4.0 x 5.4	05.5	5.0 x 5.4	0605	6.3 x 5.4
0806	8.0 x 6.2	0810	8.0 x 10.2	1010	10.0 x 10.2		

Unit : mm



STANDARD PRODUCTS

WV (VD.C)	CAP. (μ F)	SIZE (mm)		PART NO.	D.F Max. 120 Hz	LEAKAGE CURRENT (μ A/2 Min.) Max.	RIPPLE CURRENT (mA) r.m.s. 120 Hz / 85°C
		D \varnothing	L				
6.3	22	4	5.4	CB006M0022RSB-0405	0.30	3.0	29
	47	5	5.4	CB006M0047RSC-0505	0.30	3.0	46
	100	6.3	5.4	CB006M0100RSD-0605	0.30	6.3	71
	330	8	10.2	CB006M0330RSF-0810	0.35	20.8	230
10	33	5	5.4	CB010M0033RSC-0505	0.22	3.3	43
	100	6.3	5.4	CB010M0100RSD-0605	0.30	10.0	70
	100	8	6.2	CB010M0100RSE-0806	0.26	10.0	110
	220	8	10.2	CB101M0220RSF-0810	0.26	22.0	160
	470	10	10.2	CB010M0470RSG-1010	0.26	47.0	270
16	10	4	5.4	CB016M0010RSB-0405	0.16	3.0	28
	22	5	5.4	CB016M0022RSC-0505	0.16	3.5	39
	47	6.3	5.4	CB016M0047RSD-0605	0.16	7.5	70
	100	6.3	5.4	CB016M0100RSD-0605	0.26	16.0	100
	220	10	10.2	CB016M0220RSG-1010	0.20	35.2	210
	330	10	10.2	CB016M0330RSG-1010	0.20	52.8	230
	470	10	10.2	CB016M0470RSG-1010	0.20	75.2	340
25	4.7	4	5.4	CB025M4R70RSB-0405	0.14	3.0	22
	10	4	5.4	CB025M0010RSB-0405	0.16	3.0	25
	10	5	5.4	CB025M0010RSC-0505	0.14	3.0	28
	22	6.3	5.4	CB025M0022RSD-0605	0.14	5.5	55
	33	6.3	5.4	CB025M0033RSD-0605	0.14	8.3	65
	47	6.3	5.4	CB025M0047RSD-0605	0.18	11.8	80
	47	8	6.2	CB025M0047RSE-0806	0.16	11.8	91
	100	8	10.2	CB025M0100RSF-0810	0.16	25.0	130
	220	10	10.2	CB025M0220RSG-1010	0.16	55.0	190
	330	10	10.2	CB025M0330RSG-1010	0.16	82.5	340
35	4.7	4	5.4	CB035M4R70RSB-0405	0.12	3.0	22
	10	5	5.4	CB035M0010RSC-0505	0.12	3.5	30
	22	6.3	5.4	CB035M0022RSD-0605	0.12	7.7	60
	33	8	6.2	CB035M0033RSE-0806	0.14	11.6	84
	47	8	10.2	CB035M0047RSF-0810	0.14	16.5	98
	100	10	10.2	CB035M0100RSG-1010	0.14	35.0	160
	220	10	10.2	CB035M0220RSG-1010	0.14	77.0	210

STANDARD PRODUCTS

WV (V.D.C)	CAP. (μ F)	SIZE (mm)		PART NO.	D.F Max. 120 Hz	LEAKAGE CURRENT (μ A/2 Min.) Max.	RIPPLE CURRENT (mA) r.m.s. 120 Hz / 85°C
		DØ	L				
50	0.1	4	5.4	CB050M0R10RSB-0405	0.12	3.0	1
	0.22	4	5.4	CB050M0R22RSB-0405	0.12	3.0	2
	0.33	4	5.4	CB050M0R33RSB-0405	0.12	3.0	3
	0.47	4	5.4	CB050M0R47RSB-0405	0.12	3.0	5
	1	4	5.4	CB050M1R00RSB-0405	0.12	3.0	10
	2.2	4	5.4	CB050M2R20RSB-0405	0.12	3.0	16
	3.3	4	5.4	CB050M3R30RSB-0405	0.12	3.0	16
	4.7	5	5.4	CB050M4R70RSB-0405	0.12	3.0	23
	10	6.3	5.4	CB050M0010RSD-0605	0.12	5.0	35
	22	8	6.2	CB050M0022RSE-0806	0.12	11.0	70
	33	8	10.2	CB050M0033RSF-0810	0.12	16.5	91
	47	10	10.2	CB050M0047RSG-1010	0.12	23.5	100
	100	10	10.2	CB050M0100RSG-1010	0.12	50.0	120
63	10	8	6.2	CB063M0010RSE-0806	0.18	6.3	25
	22	8	10.2	CB063M0022RSF-0810	0.18	13.9	30
	33	10	10.2	CB063M0033RSG-1010	0.18	20.8	45
	47	10	10.2	CB063M0047RSG-1010	0.18	29.6	50
100	3.3	8	6.2	CB100M3R30RSE-0806	0.18	3.3	30
	4.7	8	10.2	CB100M4R70RSF-0810	0.18	4.7	50
	10	8	10.2	CB100M0010RSF-0810	0.18	10	55
	22	10	10.2	CB100M0022RSG-1010	0.18	22	60
	33	10	10.2	CB100M0033RSG-1010	0.18	33	65

Note : Extended capacitance and voltage values as well as miniaturized products are available on request.



TEMPERATURE CHARACTERISTICS DATA

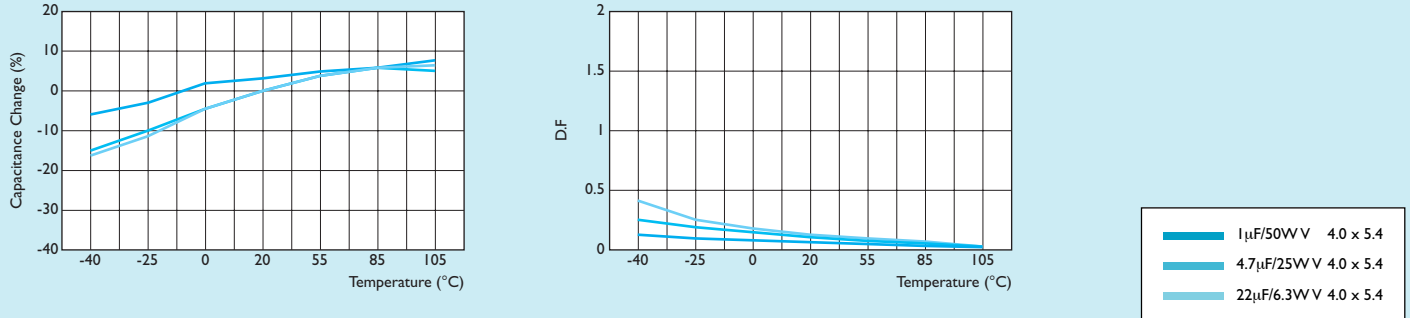

LOAD LIFE DATA

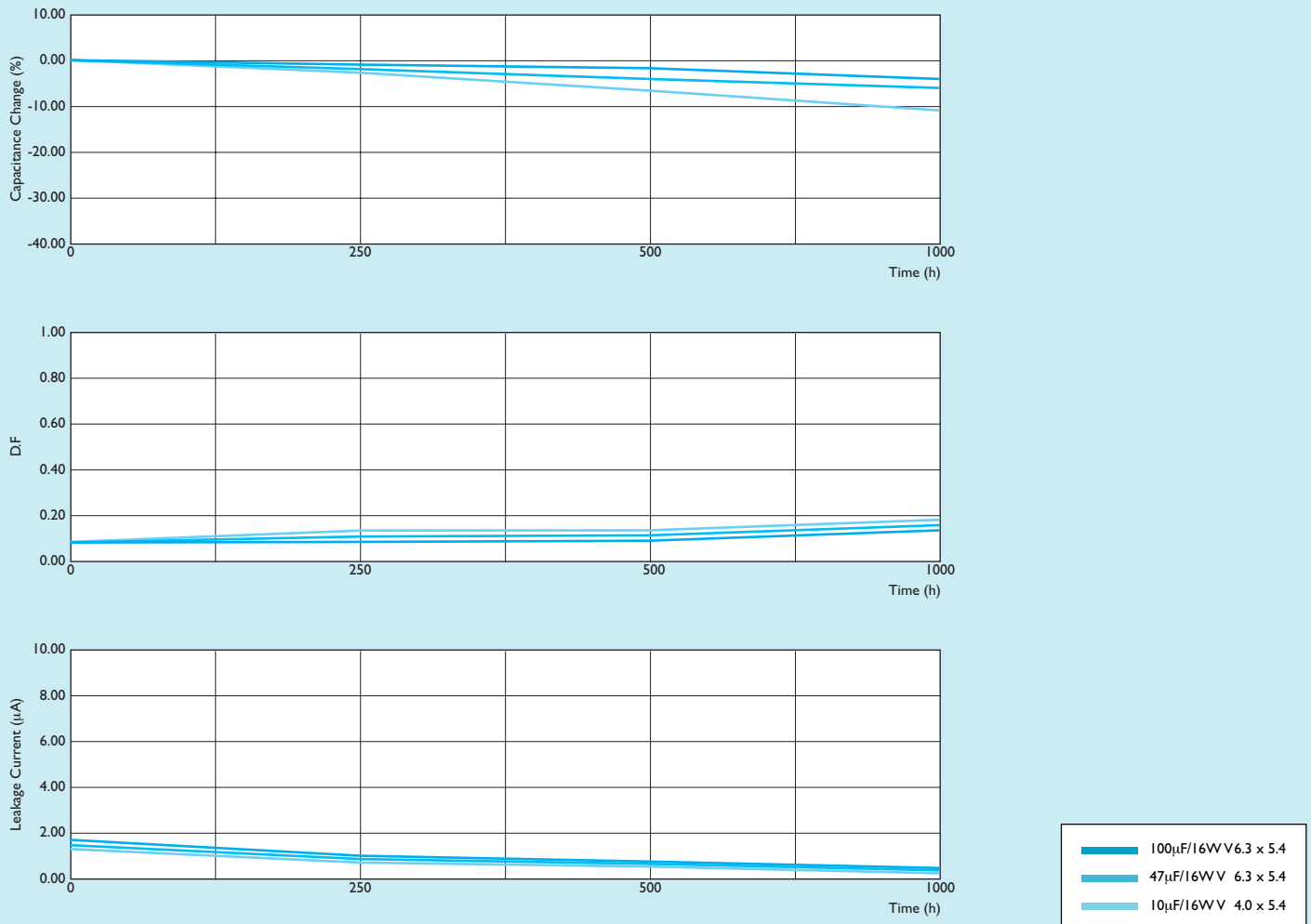

FREQUENCY CHARACTERISTICS DATA

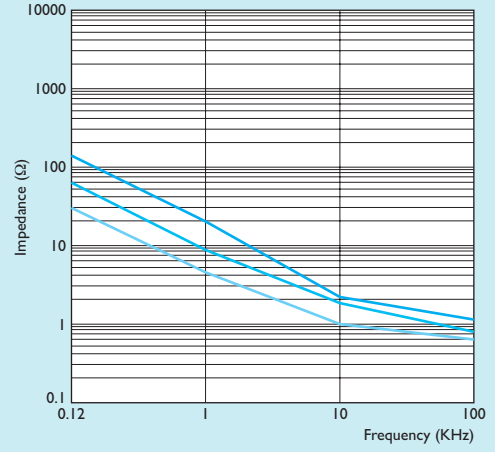
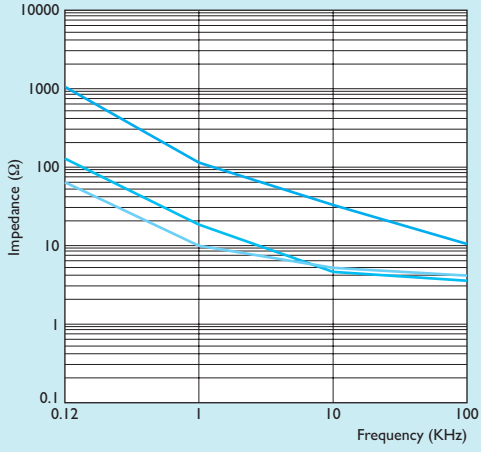

TEMPERATURE CHARACTERISTICS DATA

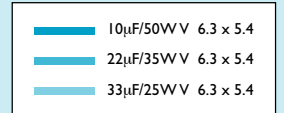
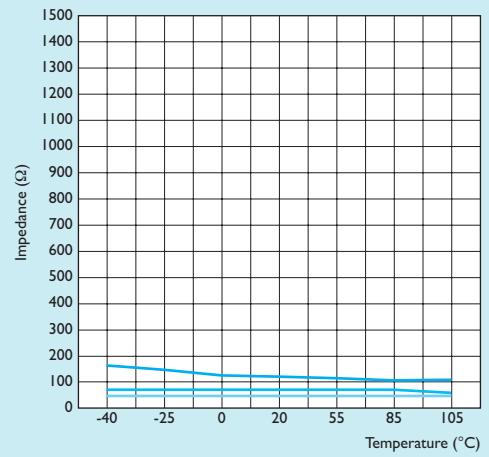
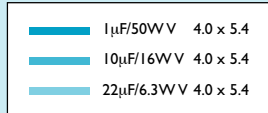
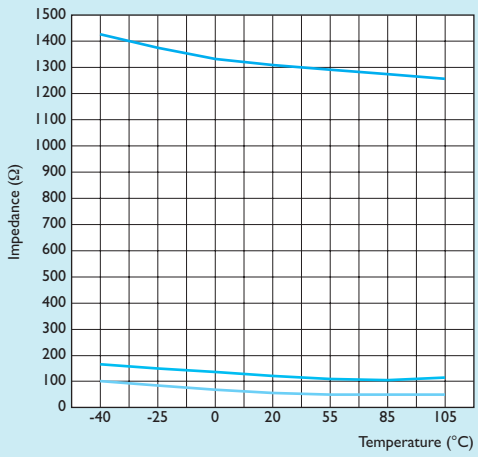

Surface Mount Aluminum Electrolytic

CE Series



FEATURE

For General Purposes Series with 105°C 2000 Hours

Suitable for AV (TV, Video, Audio), Personal Computer, Home Appliance

MARKING

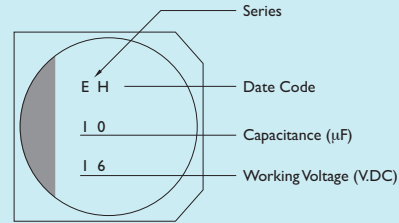

DIMENSIONS

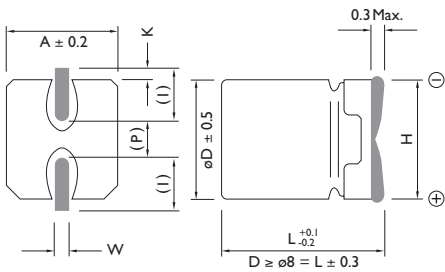

() Reference Size

Unit : mm

SIZE CODE	DØ	L	A	H	I	W	P	K
B	4.0	5.4	4.3	5.5 Max.	1.8	0.65 ± 0.1	1.0	0.35 ^{+0.15} / _{-0.20}
C	5.0	5.4	5.3	6.5 Max.	2.2	0.65 ± 0.1	1.5	0.35 ^{+0.15} / _{-0.20}
D	6.3	5.4	6.6	7.8 Max.	2.6	0.65 ± 0.1	2.2	0.35 ^{+0.15} / _{-0.20}
E	8.0	6.2	8.3	9.5 Max.	3.4	0.65 ± 0.1	2.2	0.35 ^{+0.15} / _{-0.20}
F	8.0	10.2	8.3	10.0 Max.	3.4	0.90 ± 0.2	3.1	0.70 ± 0.20
G	10.0	10.2	10.3	12.0 Max.	3.5	0.90 ± 0.2	4.6	0.70 ± 0.20

SPECIFICATION

ITEM	CHARACTERISTIC																								
Operation Temperature Range	-40 to +105°C																								
Rated Working Voltage Range	4 to 50V. DC																								
Capacitance Tolerance	±20% (120Hz / +25°C)																								
Leakage Current (25°C)	Polarized : $I \leq 0.01CV$ or 3 (µA) Whichever is greater after 2 minutes application of DC rated working voltage at 25°C. I : Leakage Current (µA) C : Rated Capacitance (µF) V : Working Voltage (V)																								
Dissipation Factor (tanδ) (120Hz / +25°C)	Polarized () : D.F. of Downsized <table border="1"> <thead> <tr> <th>WV (V)</th> <th>4</th> <th>6.3</th> <th>10</th> <th>16</th> <th>25</th> <th>35</th> <th>50</th> </tr> </thead> <tbody> <tr> <td>D.F. Ø4 ~ Ø6.3</td> <td>0.50</td> <td>0.30 (0.35)</td> <td>0.22 (0.26)</td> <td>0.16 (0.20)</td> <td>0.14 (0.18)</td> <td>0.12 (0.14)</td> <td>0.12</td> </tr> <tr> <td>Ø8 ~ Ø10</td> <td>0.40</td> <td>0.35</td> <td>0.26</td> <td>0.20</td> <td>0.16</td> <td>0.14</td> <td>0.12</td> </tr> </tbody> </table>	WV (V)	4	6.3	10	16	25	35	50	D.F. Ø4 ~ Ø6.3	0.50	0.30 (0.35)	0.22 (0.26)	0.16 (0.20)	0.14 (0.18)	0.12 (0.14)	0.12	Ø8 ~ Ø10	0.40	0.35	0.26	0.20	0.16	0.14	0.12
WV (V)	4	6.3	10	16	25	35	50																		
D.F. Ø4 ~ Ø6.3	0.50	0.30 (0.35)	0.22 (0.26)	0.16 (0.20)	0.14 (0.18)	0.12 (0.14)	0.12																		
Ø8 ~ Ø10	0.40	0.35	0.26	0.20	0.16	0.14	0.12																		
Low Temperature Stability	Impedance Ratio at 120Hz <table border="1"> <thead> <tr> <th>WV (V)</th> <th>4</th> <th>6.3</th> <th>10</th> <th>16</th> <th>25</th> <th>35</th> <th>50</th> </tr> </thead> <tbody> <tr> <td>-25 / +20°C</td> <td>7</td> <td>4</td> <td>3</td> <td>2</td> <td>2</td> <td>2</td> <td>2</td> </tr> <tr> <td>-40 / +20°C</td> <td>15</td> <td>8</td> <td>6</td> <td>4</td> <td>4</td> <td>3</td> <td>3</td> </tr> </tbody> </table>	WV (V)	4	6.3	10	16	25	35	50	-25 / +20°C	7	4	3	2	2	2	2	-40 / +20°C	15	8	6	4	4	3	3
WV (V)	4	6.3	10	16	25	35	50																		
-25 / +20°C	7	4	3	2	2	2	2																		
-40 / +20°C	15	8	6	4	4	3	3																		
Load Life	After 2000 hours application of WV at 105°C, the capacitor shall meet following limits. Capacitance Change ≤ ±20% of Initial Value Dissipation Factor ≤ 200% of Initial Specified Value Leakage Current ≤ Initial Specified Value																								
Shelf Life	At +105°C no voltage application after 1000 hours and then through the aging treatment, the capacitor shall meet limits for load life characteristics.																								

CASE SIZE & MAX RIPPLE CURRENT

Max. Ripple Current (mA) r.m.s. (120Hz / +105°C)

POLARIZED															
µF	CODE	V (CODE)													
		4 (004)		6.3 (006)		10 (010)		16 (016)		25 (025)		35 (035)		50 (050)	
0.1	0R10												4.0 x 5.4	1	
0.22	0R22												4.0 x 5.4	2	
0.33	0R33												4.0 x 5.4	3	
0.47	0R47												4.0 x 5.4	5	
1.0	1R00												4.0 x 5.4	10	
2.2	2R20												4.0 x 5.4	16	
3.3	3R30												4.0 x 5.4	16	
4.7	4R70								4.0 x 5.4	22			5.0 x 5.4	23	
6.8	0068								4.0 x 5.4	25			5.0 x 5.4	23	
10	0010						4.0 x 5.4	28	4.0 x 5.4	28	5.0 x 5.4	28	6.3 x 5.4	35	
22	0022			4.0 x 5.4	26		5.0 x 5.4	39			6.3 x 5.4	55	8.0 x 6.2	70	
33	0033			4.0 x 5.4	29	5.0 x 5.4	43			6.3 x 5.4	65	8.0 x 6.2	84	8.0 x 10.2	91
47	0047	4.0 x 5.4	34	5.0 x 5.4	46			6.3 x 5.4	70	6.3 x 5.4 8.0 x 6.2	80 91	8.0 x 10.2	98	10 x 10.2	100
100	0100	5.0 x 5.4	61	6.3 x 5.4	71	6.3 x 5.4 8.0 x 6.2	70 110	8.0 x 10.2	120	8.0 x 10.2	130	10 x 10.2	160		
150	0150	6.3 x 5.4	82												
220	0220	6.3 x 5.4	82	8.0 x 10.2	150	8.0 x 10.2	160	10 x 10.2	210	10 x 10.2	190				
330	0330			8.0 x 10.2	230			10 x 10.2	230						
470	0470					10 x 10.2	270							Size	R.C



PARTS NUMBER SYSTEM

Example : 10 μ F, 16V

CE	016	M	0010	R	E	B	-	0405
Series Name	Voltage Code	Tolerance	Capacitance Code	Package Code	Life Code	Size Code		Case Code

CAPACITANCE TOLERANCE

M	$\pm 20\%$
K	$\pm 10\%$
W	-5% ~ +20%

LIFE CODE

E	2000 Hours
S	1000 Hours
R	Special

SIZE CODE

Size Code	A	B	C	D	E	F	G
D \emptyset (mm)	3.0 x 5.4	4.0 x 5.4	5.0 x 5.4	6.3 x 5.4	8.0 x 6.2	8.0 x 10.2	10.0 x 10.2

CAPACITANCE CODE

Capacitance	0.1	0.22	0.33	0.47	1.0	2.2	3.3	4.7	6.8	10	22	33	47	100	220	330	470	1000
Code	0R10	0R22	0R33	0R47	1R00	2R20	3R30	4R70	6R80	0010	0022	0033	0047	0100	0220	0330	0470	1000

VOLTAGE CODE

Voltage	4	6.3	10	16	25	35	50	63	100
Code	004	006	010	016	025	035	050	063	100

PACKAGE CODE

R Embossed Plastic Tape Reel

CASE CODE

0305	3.0 x 5.4	0405	4.0 x 5.4	05.5	5.0 x 5.4	0605	6.3 x 5.4
0806	8.0 x 6.2	0810	8.0 x 10.2	1010	10.0 x 10.2		

Unit : mm

STANDARD PRODUCTS

WV (VD.C)	CAP. (μ F)	SIZE (mm)		PART NO.	D.F Max. 120 Hz	LEAKAGE CURRENT (μ A/2 Min.) Max.	RIPPLE CURRENT (mA) r.m.s. 120 Hz / 85°C
		DØ	L				
4	47	4	5.4	CE004M0047REB-0405	0.50	34	34
	100	5	5.4	CE004M0100REC-0505	0.50	4.0	61
	150	6.3	5.4	CE004M0150RED-0605	0.50	6.0	82
	220	6.3	5.4	CE004M0220RED-0605	0.50	8.8	82
6	22	4	5.4	CE006M0022REB-0405	0.30	3.0	26
	33	4	5.4	CE006M0033REB-0405	0.30	3.0	29
	47	5	5.4	CE006M0047REC-0505	0.30	3.0	46
	100	6.3	5.4	CE006M0100RED-0605	0.35	6.3	71
	220	8	10.2	CE006M0220REF-0810	0.35	13.8	150
	330	8	10.2	CE006M0330REF-0810	0.35	20.8	230
10	33	5	5.4	CE010M0033REC-0505	0.22	3.3	43
	100	6.3	5.4	CE010M0100RED-0605	0.26	10.0	70
	100	8	6.2	CE010M0100REE-0806	0.22	10.0	110
	220	8	10.2	CE010M0220REF-0810	0.26	22.0	160
	470	10	10.2	CE010M0470REG-1010	0.26	47.0	270
16	10	4	5.4	CE016M0010REB-0405	0.16	3.0	28
	22	5	5.4	CE016M0022REC-0505	0.16	3.5	39
	47	6.3	5.4	CE016M0047RED-0605	0.16	7.5	70
	100	6.3	5.4	CE016M0100RED-0605	0.20	16.0	120
	220	10	10.2	CE016M0220REG-1010	0.20	35.2	210
	330	10	10.2	CE016M0330REG-1010	0.20	52.8	230
25	4.7	4	5.4	CE025M4R70REB-0405	0.14	3.0	22
	6.8	4	5.4	CE025M6R80REB-0405	0.14	3.0	25
	10	4	5.4	CE025M0010REB-0405	0.14	3.0	28
	33	6.3	5.4	CE025M0033RED-0605	0.14	8.2	65
	47	6.3	5.4	CE025M0047RED-0605	0.18	11.7	80
	47	8	6.2	CE025M0047REE-0806	0.16	11.7	91
	100	8	10.2	CE025M0100REF-0810	0.16	25.0	130
	220	10	10.2	CE025M0220REG-1010	0.16	55.0	190
35	10	5	5.4	CE035M0010REC-0505	0.12	3.5	28
	22	6.3	5.4	CE035M0022RED-0605	0.12	7.7	55
	33	8	6.2	CE035M0033REE-0806	0.14	11.6	84
	47	8	10.2	CE035M0047REF-0810	0.14	16.5	98
	100	10	10.2	CE035M0100REG-1010	0.14	35.0	160
50	0.1	4	5.4	CE050M0R10REB-0405	0.12	3.0	1
	0.22	4	5.4	CE050M0R22REB-0405	0.12	3.0	2
	0.33	4	5.4	CE050M0R33REB-0405	0.12	3.0	3
	0.47	4	5.4	CE050M0R47REB-0405	0.12	3.0	5
	1	4	5.4	CE050M1R00REB-0405	0.12	3.0	10
	2.2	4	5.4	CE050M2R20REB-0405	0.12	3.0	16
	3.3	4	5.4	CE050M3R30REB-0405	0.12	3.0	16
	4.7	5	5.4	CE050M4R70REC-0505	0.12	3.0	23
	6.8	5	5.4	CE050M6R80REC-0505	0.12	3.4	23
	10	6.3	5.4	CE050M0010RED-0605	0.12	5.0	35
	22	8	6.2	CE050M0022REE-0806	0.12	11.0	70
	33	8	10.2	CE050M0033REF-0810	0.12	16.5	91
	47	10	10.2	CE050M0047REG-1010	0.12	23.5	100

Note : Extended capacitance and voltage values as well as miniaturized products are available on request.



TEMPERATURE CHARACTERISTICS DATA

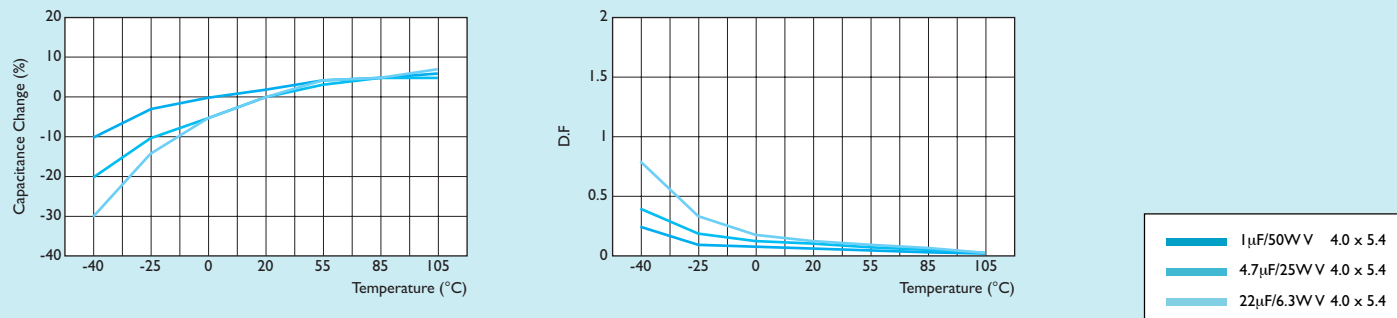

LOAD LIFE DATA

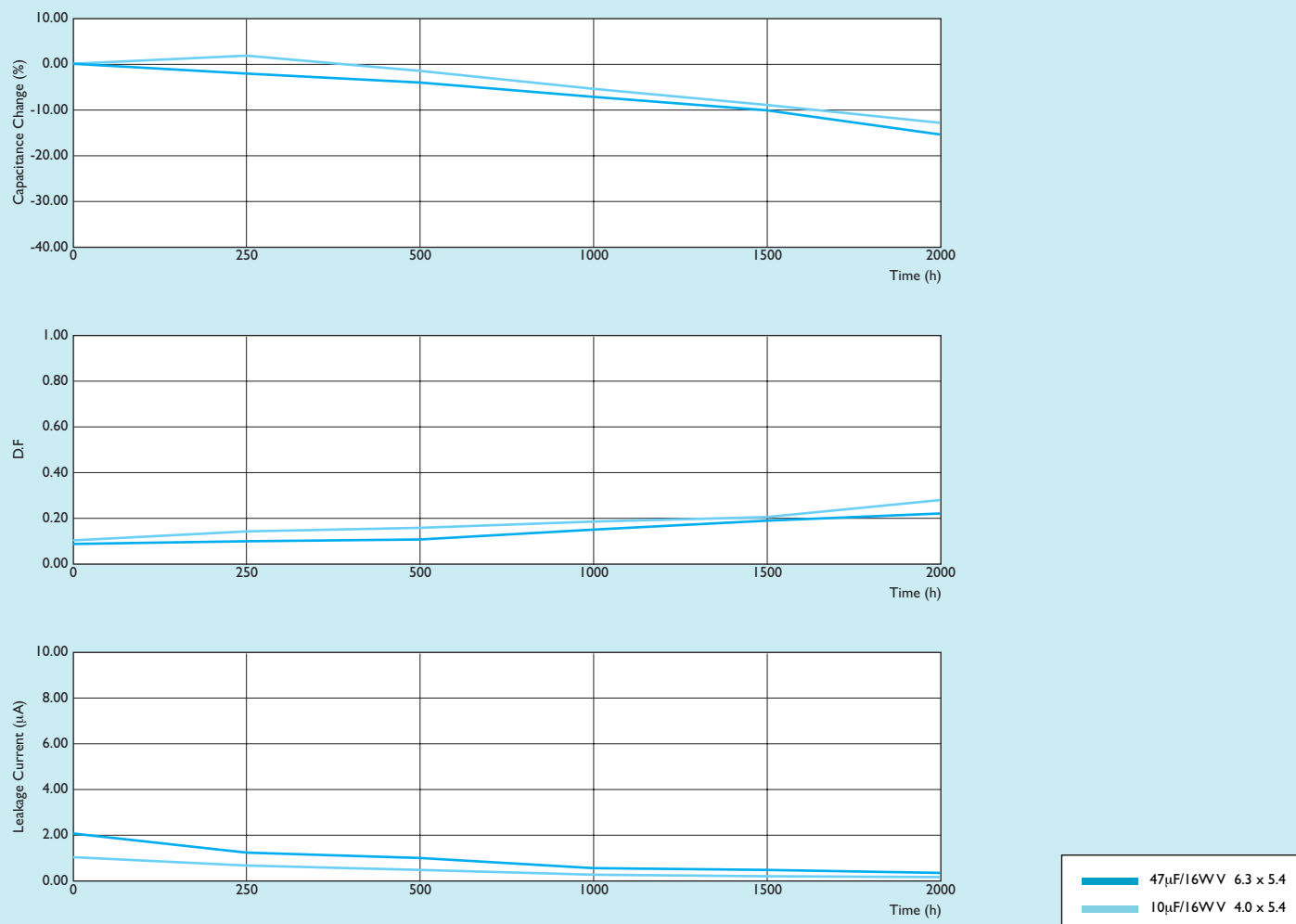

FREQUENCY CHARACTERISTICS DATA

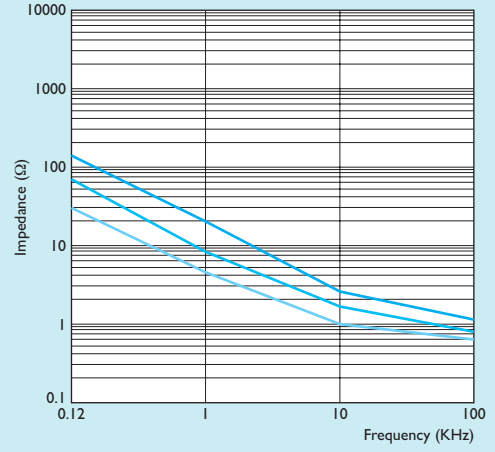
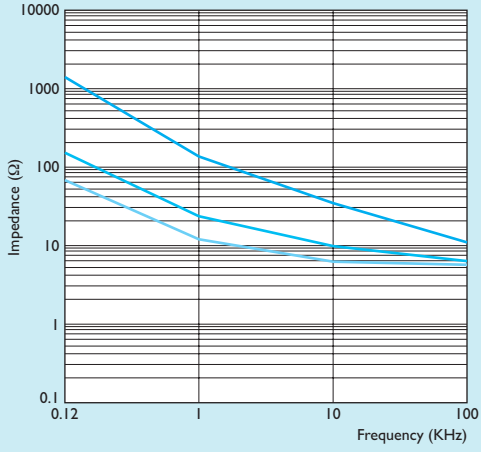

TEMPERATURE CHARACTERISTICS DATA

