

PLEASE CHECK WWW.MOLEX.COM FOR LATEST PART INFORMATION

Part Number: [0003091027](#)
Status: **Active**
Overview: [standard_093](#)
Description: 2.36mm (.093") Diameter Standard .093" Pin and Socket Receptacle Housing, 2 Circuits, With Pre-bent Mounting Ears, With Ramps

Documents:

3D Model	Product Specification PS-02-09 (PDF)
Packaging Specification (PDF)	Product Specification PS-43660-9999 (PDF)
Drawing (PDF)	RoHS Certificate of Compliance (PDF)

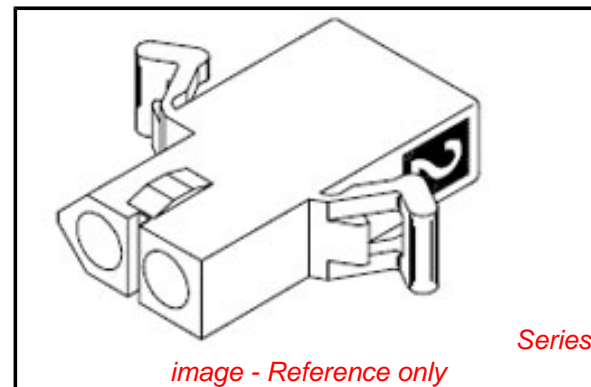

Agency Certification

CSA	LR19980
UL	E29179

General

Product Family	Crimp Housings
Series	1545
Comments	Polarized to Mating Part, 17.0A max. can be achieved when housing is used with 42477 or 42478 terminals
MolexKits	Yes
Overview	standard_093
Product Name	Standard .093"

Physical

Breakaway	No
Circuits (maximum)	2
Circuits Detail	1x2
Color - Resin	Natural
Flammability	94V-2
Gender	Dual
Glow-Wire Compliant	No
Keying to Mating Part	None
Lock to Mating Part	Yes
Material - Resin	Nylon
Number of Rows	1
Packaging Type	Bag
Panel Mount	Yes
Pitch - Mating Interface (in)	0.248 In
Pitch - Mating Interface (mm)	6.30 mm
Stackable	No
Temperature Range - Operating	-40°C to +105°C

Electrical

Current - Maximum per Contact	14A
-------------------------------	-----

Material Info

Old Part Number	1545-R3
-----------------	---------

Reference - Drawing Numbers

Packaging Specification	PK-1545-001
Product Specification	PS-02-09, PS-43660-9999
Sales Drawing	SD-1545-*

EU RoHS

ELV and RoHS Compliant
REACH SVHC
Contains SVHC: No
Halogen-Free
Status
Not Reviewed

China RoHS



Need more information on product environmental compliance?

Email productcompliance@molex.com
 For a multiple part number RoHS Certificate of Compliance, [click here](#)

Please visit the [Contact Us](#) section for any non-product compliance questions.

Search Parts in this Series

[1545Series](#)

Mates With

[1625 Plug](#)

Use With

[1189](#) Crimp Terminals, [1190](#) Crimp Terminals, [1376](#) Male PC Tail Terminals, [1377](#) Female PC Tail Terminals, [1380](#) Male Crimp Terminals, [1381](#) Female Crimp Terminals, [1433](#) Crimp Terminals, [1434](#) Male Crimp Terminals, [1973](#) Male Crimp Terminals

PLEASE CHECK WWW.MOLEX.COM FOR LATEST PART INFORMATION

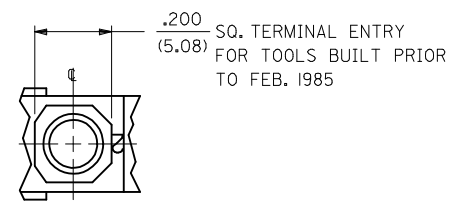
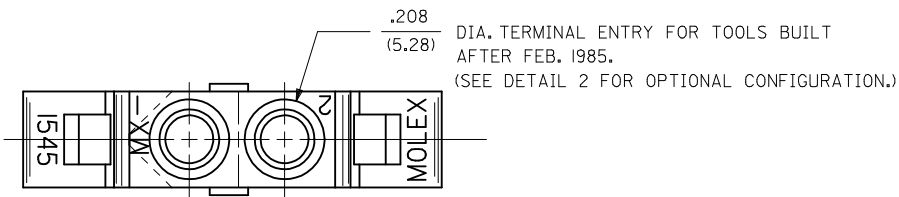

DETAIL "2"

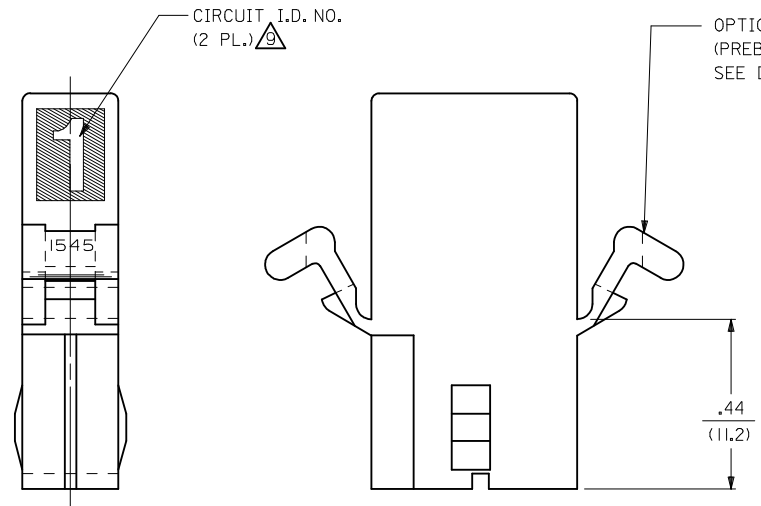

OPTIONAL MOUNTING EARS
(PREBENT SHOWN)
SEE DETAIL 3 AND 4

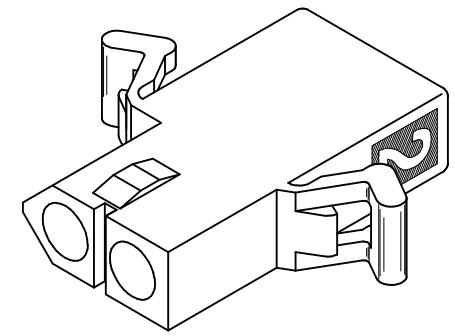
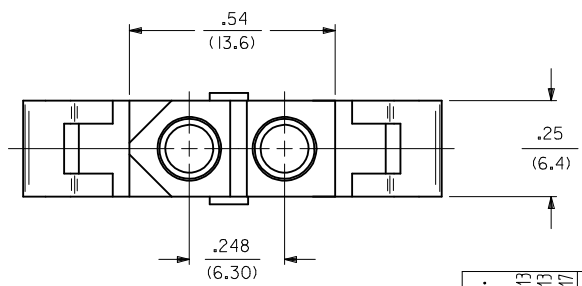
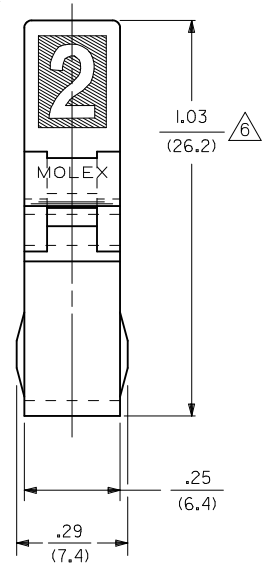

RECEPTACLE

UPDATED NOTE REF. EC NO: UCP2006-2303 DRW:PRI:DDER 2006/04/13 CHKD:AEH:HAG 2006/04/13 APPR:FSM:LTH 2006/04/17	QUALITY SYMBOLS ▽=0 ▽=0	GENERAL TOLERANCES (UNLESS SPECIFIED)		DIMENSION STYLE IN/MM	SCALE 4:1	DESIGN UNITS INCH	THIRD ANGLE PROJECTION	
		4 PLACES ± --- ± ---	3 PLACES ± --- ± .010	DRAWN BY GEP	DATE 8/9/88	TITLE .093 DIA. HOUSING PLUG & RECEPTACLE 2 CKT., .248/(6.30) CTR.		
		2 PLACES ± 0.25 ± .014	1 PLACE ± 0.35 ± ---	CHECKED BY RW	DATE 8/9/88	MOLEX INCORPORATED		
		ANGULAR ± 1°		APPROVED BY RAS	DATE 8/9/88	MATERIAL NO. SEE CHART		
DRAFT WHERE APPLICABLE MUST REMAIN WITHIN DIMENSIONS	SIZE C	THIS DRAWING CONTAINS INFORMATION THAT IS PROPRIETARY TO MOLEX INCORPORATED AND SHOULD NOT BE USED WITHOUT WRITTEN PERMISSION		DOCUMENT NO. SD-1545-*	SHEET NO. 2 OF 3			

PLUG	
PART NO.	ENG. NO.
03-09-2021	I545-P
03-09-2022	I545-P1
03-09-7021	I545-PBK
03-09-7022	I545-PIBK
03-09-2023	I545-P2
03-09-7024	I545-PIRD
03-09-7023	I545-PIBU
50-36-1686	I545-P1-1

RECEPTACLE	
PART NO.	ENG. NO.
03-09-6021	I545-R3BK
03-09-6023	I545-R3RD
03-09-6024	I545-R3BU
03-09-1022	I545-R1
03-09-1023	I545-R2
03-09-6025	I545-RIBU
03-09-1027	I545-R3
50-36-1685	I545-R1-1

LEGEND : PLUG

1545-P*****

OPTIONS: _____

BLANK = WITH STD. EARS
 1 = WITHOUT EARS
 2 = WITH PREBENT EARS

COLOR: BLANK=NATURAL COLOR _____

AM=AMBER BK=BLACK BU=BLUE
 BN=BROWN GY=GRAY GN=GREEN
 OR=ORANGE RD=RED YW=YELLOW

BLANK = MATERIAL CODE A _____
 1 = MATERIAL CODE B

LEGEND : RECEPTACLE

1545-R*****

BLANK = WITH STD. EARS & RAMPS _____
 1 = WITHOUT EARS, WITH RAMPS
 2 = WITHOUT EARS, WITHOUT RAMPS
 3 = WITH PREBENT EARS & RAMPS

COLOR: BLANK=NATURAL COLOR _____

AM=AMBER BK=BLACK BU=BLUE
 BN=BROWN GY=GRAY GN=GREEN
 OR=ORANGE RD=RED YW=YELLOW

BLANK = MATERIAL CODE A _____
 1 = MATERIAL CODE B

NOTES:

- MATERIAL: - A = NYLON, PA66, 94V-2. COLOR: SEE LEGEND.
 B = UL94V-0, PA6 NYLON, IEC 60335-1, 4TH EDITION GLOW WIRE CAPABLE.
- FINISH: NONE.
- PRODUCT SPECIFICATION: PS-02-09.
- PACKAGING INFORMATION: PK-1545-001
- .97/(24.6) REF. FOR TOOLS BUILT PRIOR TO FEB. 1985.
- 1.00/(25.4) REF. FOR TOOLS BUILT PRIOR TO FEB. 1985.
- RIBS ARE PRESENT ONLY ON PARTS WITH MOUNTING EARS.
- EACH TERMINAL POCKET WILL ACCEPT UP TO:
 (2) #18 AWG WIRES HAVING 1/32" THK. INSULATION OR
 (1) #16 AWG WIRE HAVING 1/16" THK. INSULATION OR
 (1) #16 AWG & (1) 18 AWG WIRE HAVING 1/32" THK. INSULATION .
- CIRCUIT I.D. NUMBERS ON SIDE OF HOUSING APPEAR ON PARTS FROM TOOLS BUILT AFTER 11/25/91.
- PARTS CONFORM TO CLASS 'B' REQUIREMENTS OF COSMETIC SPECIFICATION PS-45499-002 EXCEPT MATERIAL OPTION 'B' MEETS CLASS 'C' REQUIREMENTS FOR SINK AND DISCOLORATION.

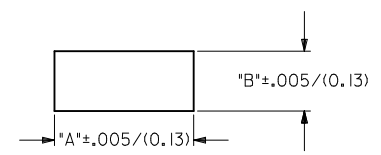
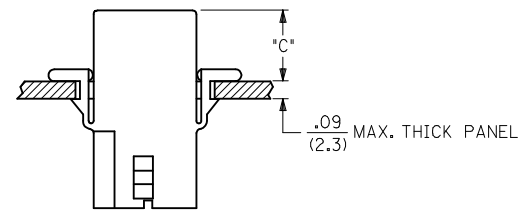

RECOMMENDED PANEL OPENING
(SCALE 2:1)

HOUSING	DIM. "A"	DIM. "B"	DIM. "C" (PREBENT)	DIM. "C" (STD. EAR)
PLUG	.800/(20.32)	.375/(9.53)	.40/(10.2)	.39/(9.9)
RECEPTACLE	.725/(18.42)	.312/(7.92)	.41/(10.4)	.40/(10.2)

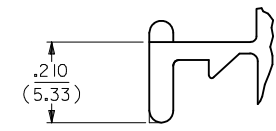

DETAIL 3

.093/(2.36) STANDARD MOUNTING EAR
(SCALE 4:1)

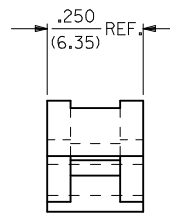

DETAIL 4

.093/(2.36) PREBENT MOUNTING EAR
(SCALE 4:1)

ADD MAT'L & P/N'S EC NO: UCP2007-2366 DR:WNAELHAG 2007/05/25 CHK:KLSCHMIDT 2007/06/01 APPR:FSMITH 2007/06/04 REV: V	QUALITY SYMBOLS ▽=0 ▽=0	GENERAL TOLERANCES (UNLESS SPECIFIED)		DIMENSION STYLE IN/MM	SCALE 2:1	DESIGN UNITS INCH	THIRD ANGLE PROJECTION		
		4 PLACES ± --- ± --- 3 PLACES ± --- ± .010 2 PLACES ± 0.25 ± .014 1 PLACE ± 0.35 ± ---	mm INCH ± .010 ± .014 ± 0.25 ± .014 ± 0.35 ± ---	DRAWN BY GEP	DATE 8/9/88	TITLE .093/(2.36) HOUSING, PLUG & RECEPTACLE, 2 CKT., .248/(6.30) CTR.	MOLEX INCORPORATED		
		ANGULAR ± 1 °		CHECKED BY RW	DATE 8/9/88	MATERIAL NO. SEE CHART	DOCUMENT NO. SD-1545-*	SHEET NO. 3 OF 3	
		DRAFT WHERE APPLICABLE MUST REMAIN WITHIN DIMENSIONS		THIS DRAWING CONTAINS INFORMATION THAT IS PROPRIETARY TO MOLEX INCORPORATED AND SHOULD NOT BE USED WITHOUT WRITTEN PERMISSION					