

MECHANICAL DATA

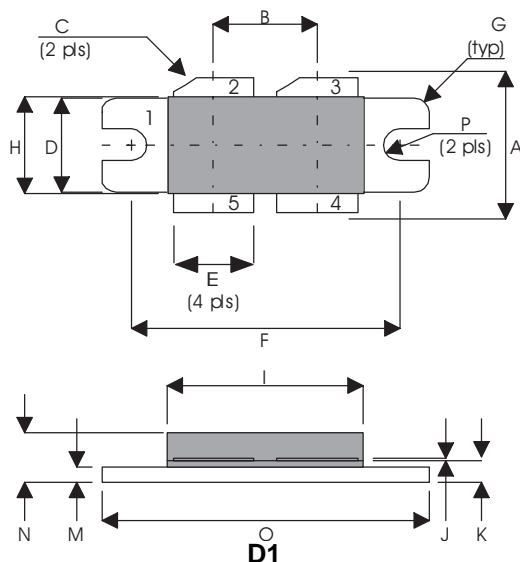

PIN 1 SOURCE (COMMON) PIN 2 DRAIN 1
 PIN 3 DRAIN 2 PIN 4 GATE 2
 PIN 5 GATE 1

DIM	Millimetres	Tol.	Inches	Tol.
A	15.24	0.50	0.600	0.020
B	10.80	0.13	0.425	0.005
C	45°	5°	45°	5°
D	9.78	0.13	0.385	0.005
E	8.38	0.13	0.330	0.005
F	27.94	0.13	1.100	0.005
G	1.52R	0.13	0.060R	0.005
H	10.16	0.15	0.400	0.006
I	21.84	0.23	0.860	0.009
J	0.10	0.02	0.004	0.001
K	1.96	0.13	0.077	0.005
M	1.02	0.13	0.040	0.005
N	4.45	0.38	0.175	0.015
O	34.04	0.13	1.340	0.005
P	1.63R	0.13	0.064R	0.005

GOLD METALLISED
MULTI-PURPOSE SILICON
DMOS RF FET
300W – 50V – 175MHz
PUSH-PULL

FEATURES

- SUITABLE FOR BROAD BAND APPLICATIONS
- SIMPLE BIAS CIRCUITS
- ULTRA-LOW THERMAL RESISTANCE
- BeO FREE
- LOW Crss
- HIGH GAIN – 20 dB MINIMUM

APPLICATIONS

- VHF/UHF COMMUNICATIONS
from 1 MHz to 175 MHz

P_D	Power Dissipation	875W (438W -A Version)
BV_{DSS}	Drain – Source Breakdown Voltage *	125V
BV_{GSS}	Gate – Source Breakdown Voltage*	±20V
$I_{D(sat)}$	Drain Current*	18A
T_{stg}	Storage Temperature	-65 to 150°C
T_j	Maximum Operating Junction Temperature	200°C

* Per Side

Semelab Plc reserves the right to change test conditions, parameter limits and package dimensions without notice. Information furnished by Semelab is believed to be both accurate and reliable at the time of going to press. However Semelab assumes no responsibility for any errors or omissions discovered in its use. Semelab encourages customers to verify that datasheets are current before placing orders.

ELECTRICAL CHARACTERISTICS (T_{case} = 25°C unless otherwise stated)

Parameter		Test Conditions		Min.	Typ.	Max.	Unit
PER SIDE							
B _V DSS	Drain–Source Breakdown Voltage	V _{GS} = 0	I _D = 100mA	125			V
I _D DSS	Zero Gate Voltage Drain Current	V _{DS} = 125V	V _{GS} = 0			6	mA
I _G DSS	Gate Leakage Current	V _{GS} = 20V	V _{DS} = 0			6	μA
V _{GS(th)}	Gate Threshold Voltage*	I _D = 10mA	V _{DS} = V _{GS}	1		7	V
g _{fs}	Forward Transconductance*	V _{DS} = 10V	I _D = 3A	4.8			mhos
V _{GS(th)match}	Gate Threshold Voltage Matching Between Sides	I _D = 10mA	V _{DS} = V _{GS}			0.1	V
TOTAL DEVICE							
G _{PS}	Common Source Power Gain	P _O = 300W		20			dB
η	Drain Efficiency	V _{DS} = 50V	I _{DQ} = 1.2A	60			%
VSWR	Load Mismatch Tolerance	f = 175MHz		20:1			—
PER SIDE							
C _{iss}	Input Capacitance	V _{DS} = 50V	V _{GS} = -5V f = 1MHz			360	pF
C _{oss}	Output Capacitance	V _{DS} = 50V	V _{GS} = 0 f = 1MHz			150	pF
C _{rss}	Reverse Transfer Capacitance	V _{DS} = 50V	V _{GS} = 0 f = 1MHz			9	pF

* Pulse Test: Pulse Duration = 300 μs , Duty Cycle ≤ 2%

THERMAL DATA

R _{THj-case}	Thermal Resistance Junction – Case	Max. 0.2°C / W 0.4 °C / W -A Version
-----------------------	------------------------------------	---

Semelab Plc reserves the right to change test conditions, parameter limits and package dimensions without notice. Information furnished by Semelab is believed to be both accurate and reliable at the time of going to press. However Semelab assumes no responsibility for any errors or omissions discovered in its use. Semelab encourages customers to verify that datasheets are current before placing orders.

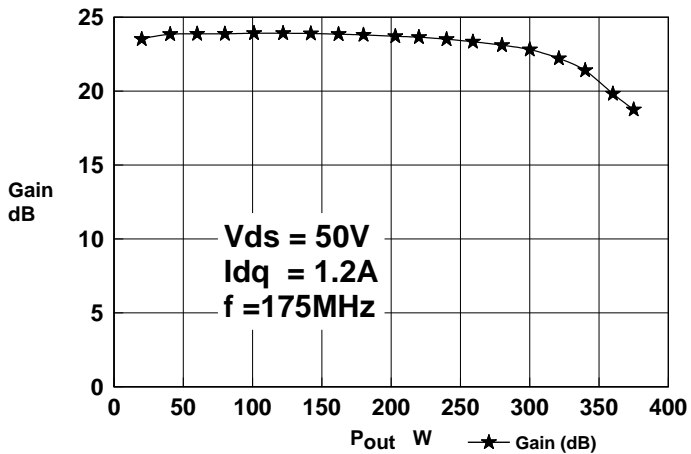

Figure 1 – Gain vs. Power Output.

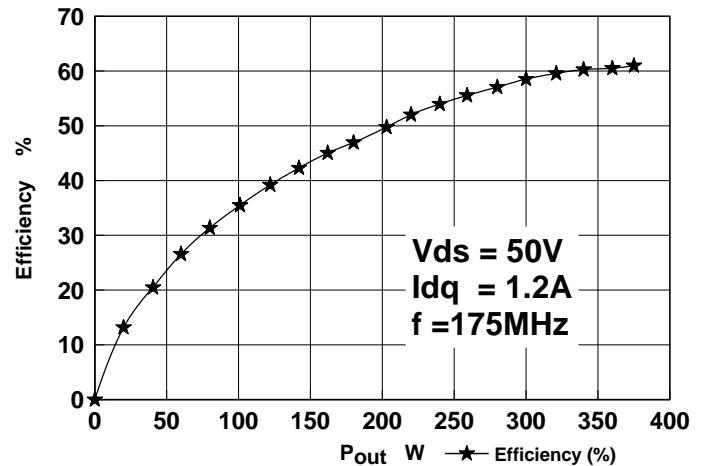

Figure 2 – Efficiency vs. Power Output.

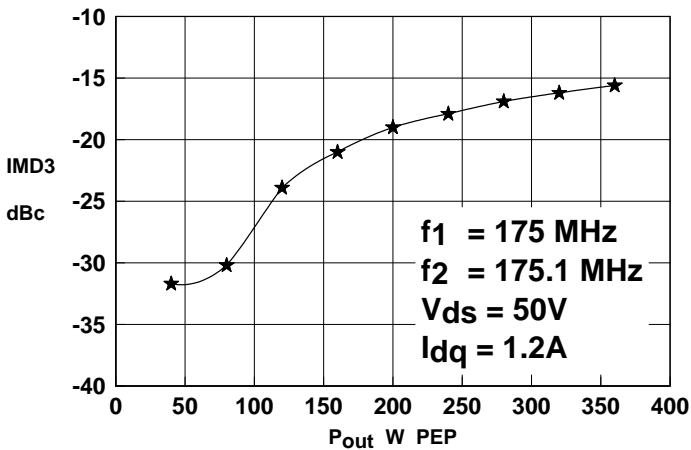

Figure 3 – IMD vs. Power Output

Semelab Plc reserves the right to change test conditions, parameter limits and package dimensions without notice. Information furnished by Semelab is believed to be both accurate and reliable at the time of going to press. However Semelab assumes no responsibility for any errors or omissions discovered in its use. Semelab encourages customers to verify that datasheets are current before placing orders.

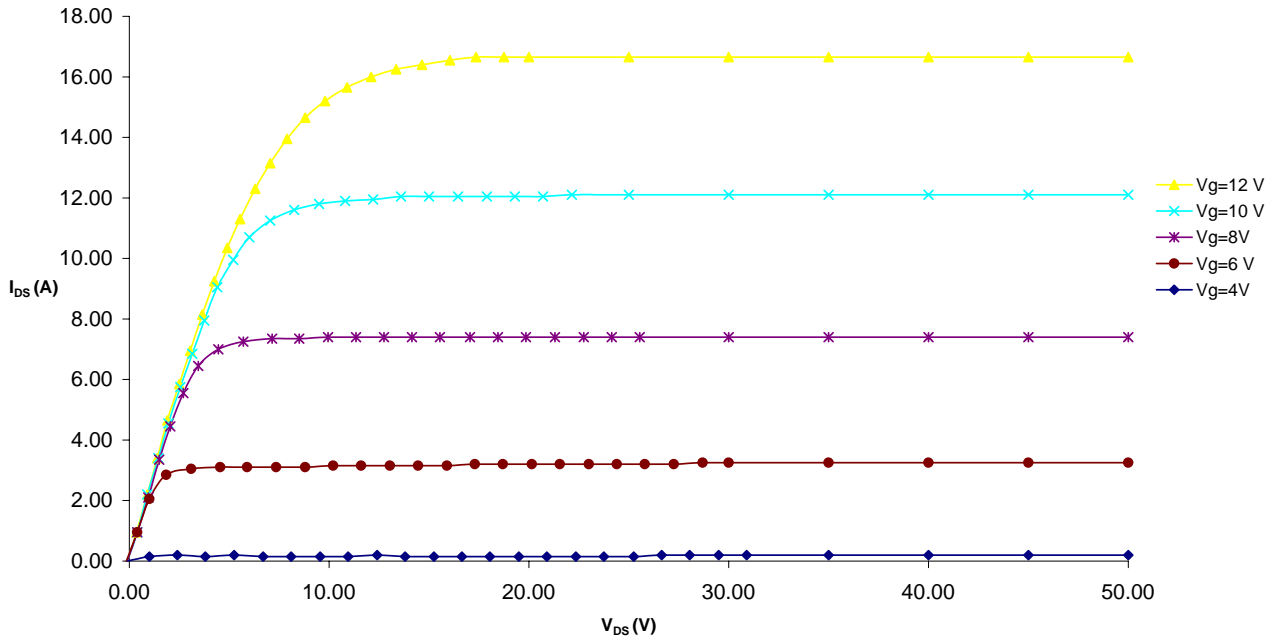

Figure 4 – Typical IV Characteristics.

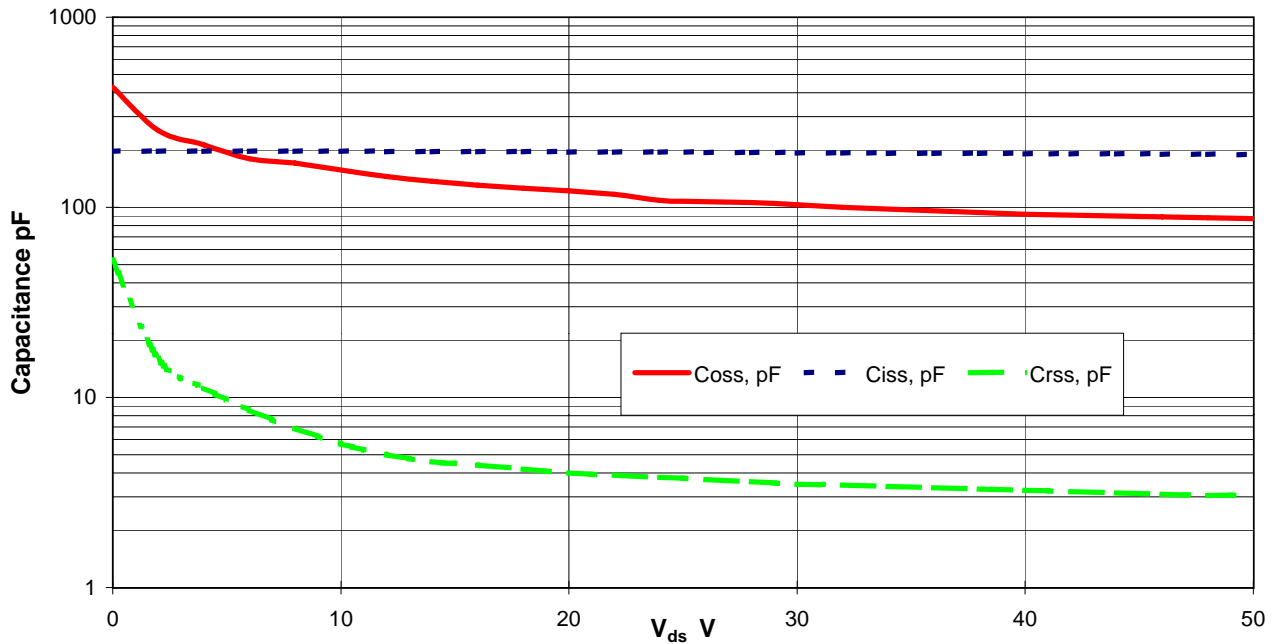
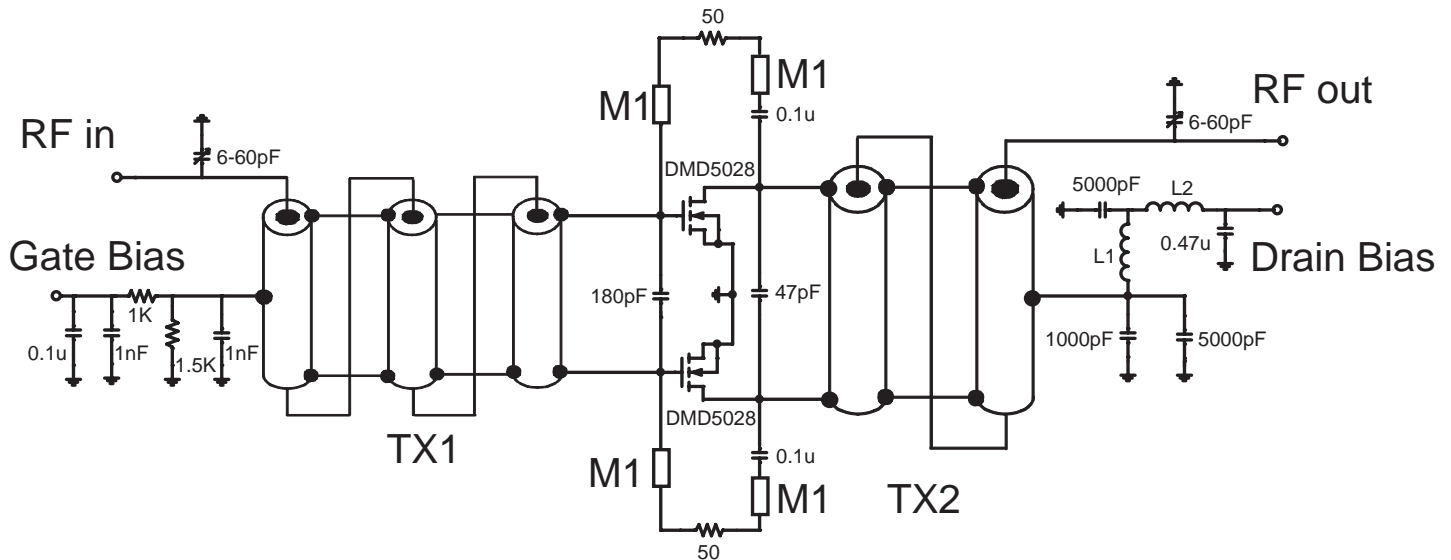

Figure 5 – Typical CV Characteristics.

Semelab Plc reserves the right to change test conditions, parameter limits and package dimensions without notice. Information furnished by Semelab is believed to be both accurate and reliable at the time of going to press. However Semelab assumes no responsibility for any errors or omissions discovered in its use. Semelab encourages customers to verify that datasheets are current before placing orders.



DMD5028 175MHz TEST FIXTURE

- TX1** 9:1 transformer. 3 turns of 062-25 semi-rigid coax around 75-26 powdered iron core
- TX2** 4:1 transformer. 2 turns of 090-25 semi-rigid coax around 100-8 powdered iron core
- L1** 10 turns 16awg enamelled wire, 5mm internal diameter
- L2** 0.5 turns 16 awg enamelled wire on A1 x 1 2-hole core
- M1** microstrip line, 20mm long, 1mm wide on 0.062in thick G10 substrate