



# PRODUCT SPECIFICATION

**Model No : CSM-57071M9/CSM-57081M9**

Descriptions:
<ul style="list-style-type: none"> <li>• 0.7Inch Dot-Matrix Display</li> <li>• 5*7 Array with X-Y Select.</li> <li>• CSM-57071: Column Anode, Row Cathode</li> <li>• CSM-57081: Column Cathode, Row Anode</li> <li>• Emitting Color: Super-Bright Green</li> </ul>



CUSTOMER APPROVED SIGNATURES	APPROVED BY	CHECKED BY	PREPARED BY

**CHINA SEMICONDUCTOR CORPORATION**  
Address:2FL. NO.909,Chung-Cheng Road,  
Chung-Ho City Taipei Hsien,Taiwan.

Tel:886-2-2223-9696  
Fax:886-2-2223-9377

**OPTO PLUS TECHNOLOGIES CO.,LTD**  
Address:696 Shun jiang Rd.,Ji Shan St.Shaoxing  
ZheJiang,China

Tel:86-0575-88623888  
Fax:86-0575-88623112



**Model No : CSM-57071M9/CSM-57081M9**

**Features -**

1. 0.7 inch (17.2mm) Matrix height.
2. Case mold type.
3. RoHs compliant.
4. Low power consumption.
5. Easy mounting on P.C. board or socket.

**Device Selection Guide -**

Part No.	Chip		Description	
	Material	Emitted Color	Column	Row
CSM-57071M9	AlGaInP	Super-Bright Green	Anode	Cathode
CSM-57081M9			Cathode	Anode

**Package Dimensions -**

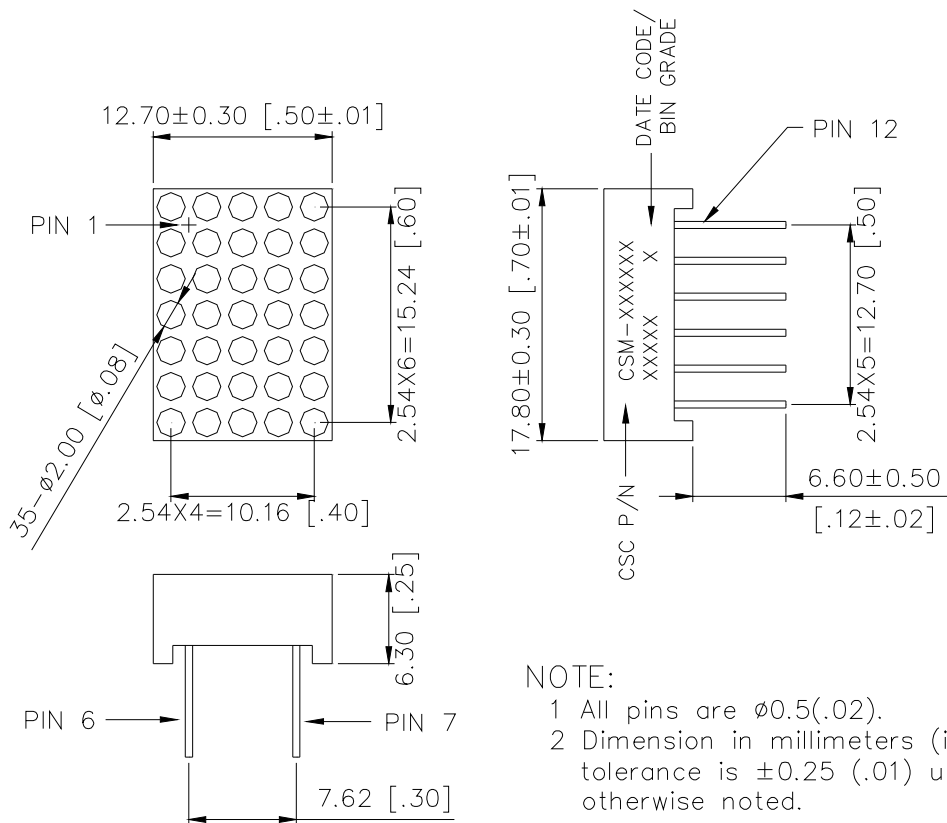

**NOTE:**

- 1 All pins are  $\phi 0.5$  (.02).
- 2 Dimension in millimeters (inch), tolerance is  $\pm 0.25$  (.01) unless otherwise noted.



Model No : CSM-57071M9/CSM-57081M9

Internal Circuit Diagrams -

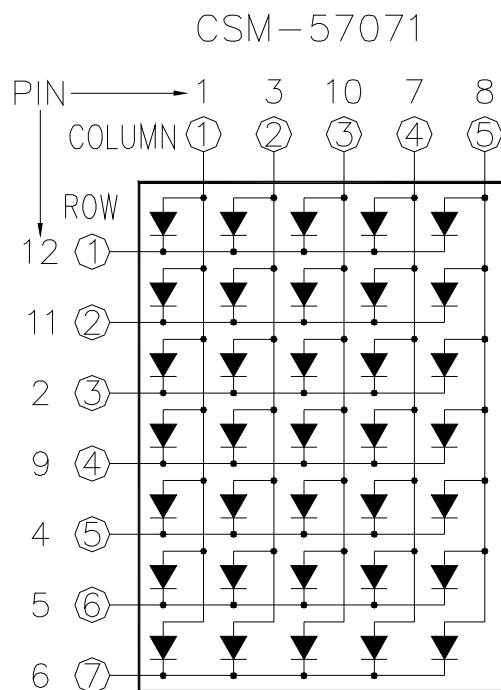

CSM-57071				CSM-57081			
PIN NO.	FUNCTION	PIN NO.	FUNCTION	PIN NO.	FUNCTION	PIN NO.	FUNCTION
1	Anode Column 1	7	Anode Column 4	1	Cathode Column 1	7	Cathode Column 4
2	Cathode Row 3	8	Anode Column 5	2	Anode Row 3	8	Cathode Column 5
3	Anode Column 2	9	Cathode Row 4	3	Cathode Column 2	9	Anode Row 4
4	Cathode Row 5	10	Anode Column 3	4	Anode Row 5	10	Cathode Column 3
5	Cathode Row 6	11	Cathode Row 2	5	Anode Row 6	11	Anode Row 2
6	Cathode Row 7	12	Cathode Row 1	6	Anode Row 7	12	Anode Row 1



Model No : CSM-57071M9/CSM-57081M9

■ Absolute Maximum Rating -

(Ta=25°C)

Parameter	Symbol	Rating	Unit
Power Dissipation Per Dice	P <sub>AD</sub>	70	mW
Continuous Forward Current Per Dice	I <sub>AF</sub>	25	mA
Peak Current Per Dice(duty cycle 1/10, 1kHz)	I <sub>PF</sub>	90	mA
Derating Linear From 25°C Per Dice	-	0.33	mA/°C
Reverse Voltage Per Dice	V <sub>R</sub>	5	V
Operating Temp.	T <sub>opr</sub>	-35 ~ +85	°C
Storage Temp.	T <sub>stg</sub>	-35 ~ +85	°C
Solder temperature 1/16 inch below seating plane for 3 seconds at 260°C			

■ Electro-optical Characteristics -

(Ta=25°C)

Parameter	Symbol	Min.	Typ.	Max.	Unit	Condition
Forward Voltage Per Segment	V <sub>F</sub>	-	2.1	2.8	V	I <sub>F</sub> =20mA
Luminous Intensity Per Segment	I <sub>v</sub>	-	7400	-	ucd	I <sub>F</sub> =10mA
Peak Emission Wavelength	λ <sub>p</sub>	-	570	-	nm	I <sub>F</sub> =20mA
Dominant Wavelength	λ <sub>d</sub>	-	572	-	nm	I <sub>F</sub> =20mA
Spectrum Radiation Bandwidth	Δλ	-	30	-	nm	I <sub>F</sub> =20mA
Reverse Current	I <sub>R</sub>	-	-	100	μA	V <sub>R</sub> =5V
Luminous Intensity Matching Ratio	I <sub>V-m</sub>	-	-	2:1	-	I <sub>p</sub> =80mA 1/16Duty



Model No : CSM-57071M9/CSM-57081M9

### Typical Electrical / Optical Characteristics Curves -

(Ta = 25°C Unless Otherwise Noted)

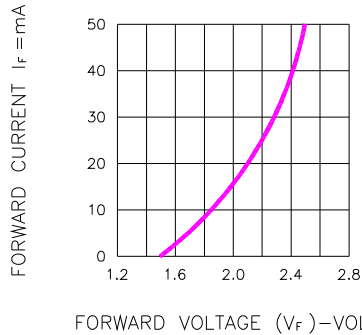

Fig.1 FORWARD CURRENT VS. FORWARD VOLTAGE

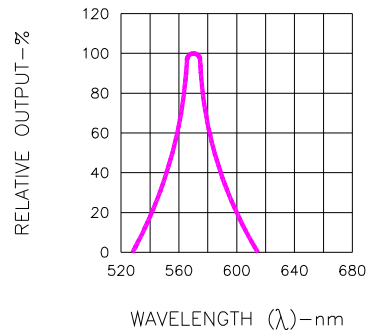

Fig.2 SPECTRAL RESPONSE

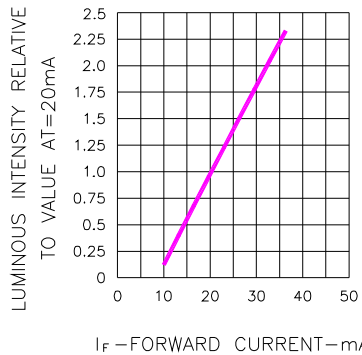

Fig.3 RELATIVE LUMINOUS INTENSITY VS. FORWARD CURRENT

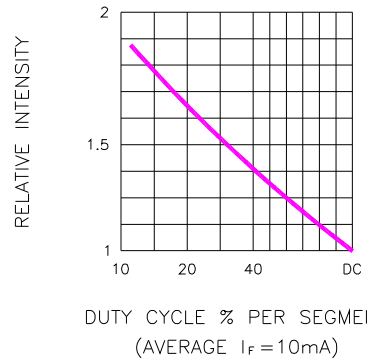

Fig.5 LUMINOUS INTENSITY VS. DUTY CYCLE

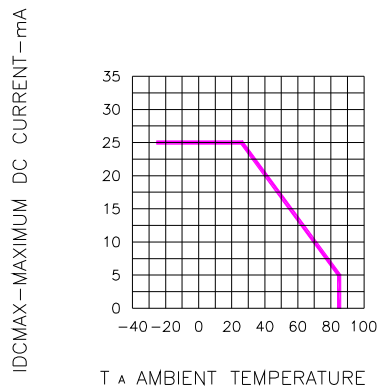

Fig.4 MAXIMUM ALLOWABLE DC CURRENT PER SEGMENT VS. A FUNCTION OF AMBIENT TEMPERATURE

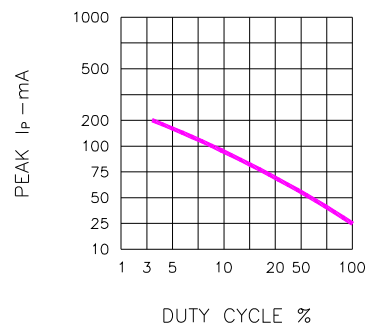

Fig.6 MAX PEAK CURRENT VS. DUTY CYCLE % (REFRESH RATE f=1 KHz)



**CHINA  
SEMICONDUCTOR  
CORPORATION**

Spec. No.	PS-ND-0710
Rev.	A

**Model No : CSM-57071M9/CSM-57081M9**

■ Package Dimensions

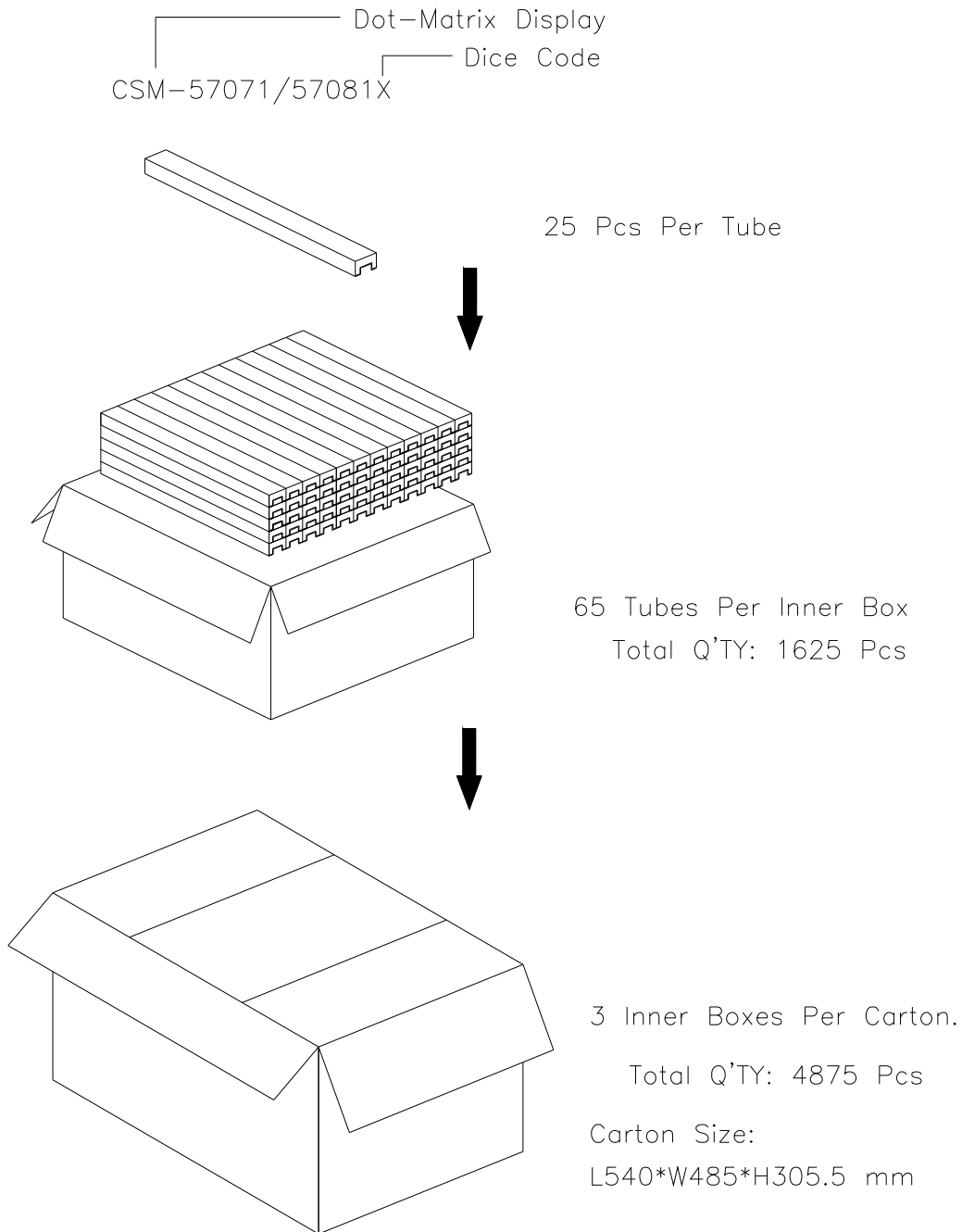

Note: The specifications are subject to change without notice. Please contact us for updated information