

PLEASE CHECK WWW.MOLEX.COM FOR LATEST PART INFORMATION

Part Number: [0357160193](#)
Status: **Active**
Description: 2.36mm (.093") Diameter Pin Wire-to-Board Terminal, Female, Brass, Wire Range 20-24 AWG (0.52-0.20mm²), Pre-Ni Plated, Low Tension

Documents:

[Drawing \(PDF\)](#) [RoHS Certificate of Compliance \(PDF\)](#)

General

Product Family	Crimp Terminals
Series	35716
Crimp Quality Equipment	Yes
Product Name	N/A

Physical

Gender	Female
Material - Metal	Brass
Material - Plating Mating	Nickel
Packaging Type	Reel
Plating min: Mating (µin)	39
Plating min: Mating (µm)	1
Termination Interface: Style	Crimp or Compression
Wire Insulation Diameter	2.70mm (.106") max.
Wire Size AWG	20, 22, 24
Wire Size mm ²	N/A

Material Info

Reference - Drawing Numbers

Sales Drawing	SD-35716-001
---------------	--------------

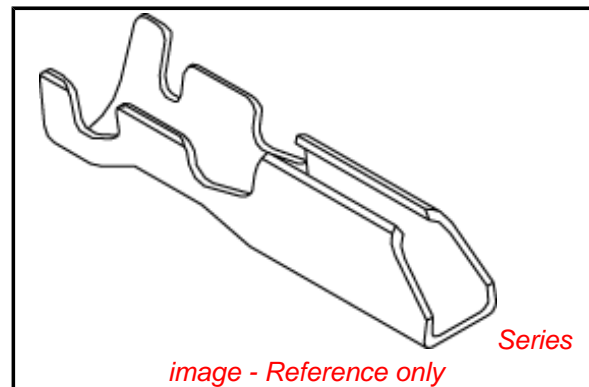

EU RoHS

**ELV and RoHS
Compliant**
**REACH SVHC
Contains SVHC: No**
**Halogen-Free
Status**

China RoHS



**Need more information on product
environmental compliance?**

Email productcompliance@molex.com
 For a multiple part number RoHS Certificate of Compliance, [click here](#)

Please visit the [Contact Us](#) section for any non-product compliance questions.

Search Parts in this Series
[35716Series](#)

Use With
[35183](#)

DWG. NO.
SD-35716-001

SIMILAR ITEM

PROJECT NO.

B

DO NOT SCALE DRAWING
DIMENSION IN METRIC

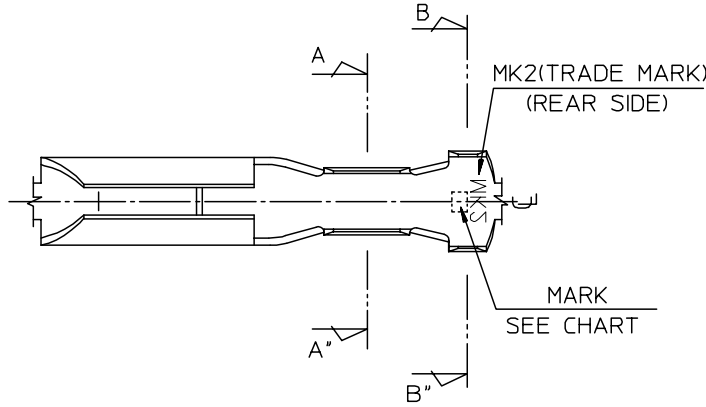
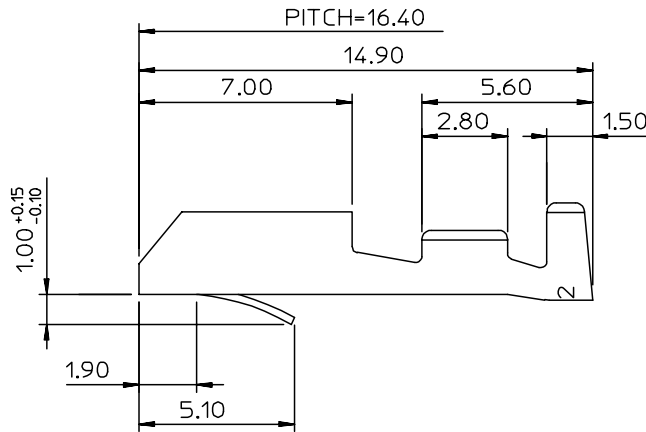
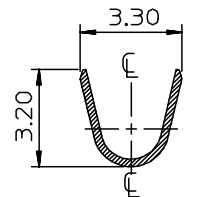
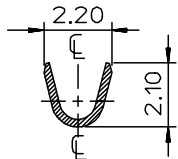
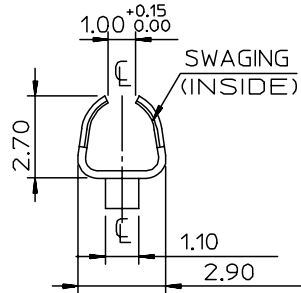
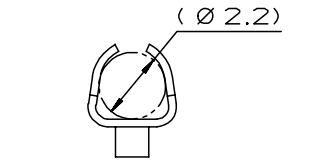

NOTES

1. MATERIAL & PLATING: SEE CHART
2. MATING PIN : 2.36 DIA. ROUND PIN
3. APPLICABLE WIRE RANGE: AWG #24-#20
INSULATION DIAMETER: 1.5-2.7mm
4. RECOMMENDED LENGTH OF WIRE STRIP IS 3.7-4.5mm.

CHART	ENG.NO.	ENG.NO.	MATERIAL	PLATING	MARK
	35716-0110	357160110	BRASS	PRE-TIN	I : (1UP LINE)
	35716-0111	357160111	PHOS.BRONZE	PRE-TIN	II : (2UP LINE)
	35716-0190	357160190	BRASS	PRE-Ni	N1 : (1UP LINE) N2 : (2UP LINE)
35716-0193	357160193	BRASS	PRE-Ni	SI : (1UP LINE) SII : (2UP LINE)	

REVISED ECN NO. KOR2004-0068 DRWN:CB,CHIN 03/11/13 CHK: W.Y.YANG APPR: CW,LEE	DESCRIPTION	QUALITY SYMBOLS	GENERAL TOLERANCES: (UNLESS SPECIFIED)		SCALE	DESIGN UNITS	THIRD ANGLE PROJECTION	DIMENSIONS:	SHT	REV
		MAJOR ▼ = 0	m/m	INCH	□ m/m	□ INCH	□ m/m ONLY	REVISION		
		CRITICAL ▽ = 0	4 PLACES ±0.	±-	DRAWN BY & DATE W.Y.YANG 91/10/14	TITLE: 2.36 DIA PIN RECEPTACLE TERMINAL				
			3 PLACES ±0.	±-	CHECKED BY & DATE B.K.CHOI 91/10/14	MOLEX INCORPORATED				
		2 PLACES ±0.30	±-	APPROVED BY & DATE C.W.LEE 91/10/14	CAD FILENAME S7160110.MI	MATERIAL NO. SEE CHART	DRAWING NO. SD-35716-001	SHEET NO. 10F1		
		1 PLACE ±0.30	±-	DRAFT WHERE APPLICABLE MUST REMAIN WITHIN DIMENSIONS		THIS DRAWING CONTAINS INFORMATION THAT IS PROPRIETARY TO MOLEX INCORPORATED AND SHOULD NOT BE USED WITHOUT WRITTEN PERMISSION.				SIZE B
G	REV									