

Features

- Attenuation: 0.5 dB steps to 15.5 dB
- Minimal Phase Variation over Attenuation Range
- Low DC Power Consumption
- Hermetic Surface Mount Package
- Integral TTL Driver
- 50 Ohm Nominal Impedance
- 260°C Reflow Compatible
- RoHS* Compliant

Description

M/A-COM's MAAD-009195-000100 is a GaAs FET 5-bit digital attenuator with a 0.5 dB minimum step size and 15.5 dB total attenuation. The design has been optimized to minimize phase variation over the attenuation range. This attenuator and integral TTL driver is in a hermetically sealed ceramic 16-lead surface mount package. The MAAD-009195-000100 is ideally suited for use where accuracy, fast switching, very low power consumption and low intermodulation products are required. Typical applications include dynamic range setting in precision receiver circuits and other gain/leveling control circuits. Environmental screening is available. Contact the factory for information.

Ordering Information

Part Number	Package
MAAD-009195-000100	Bulk Packaging
MAAD-009195-0001TB	Sample Test Board

Note: Reference Application Note M513 for reel size information.

Functional Schematic

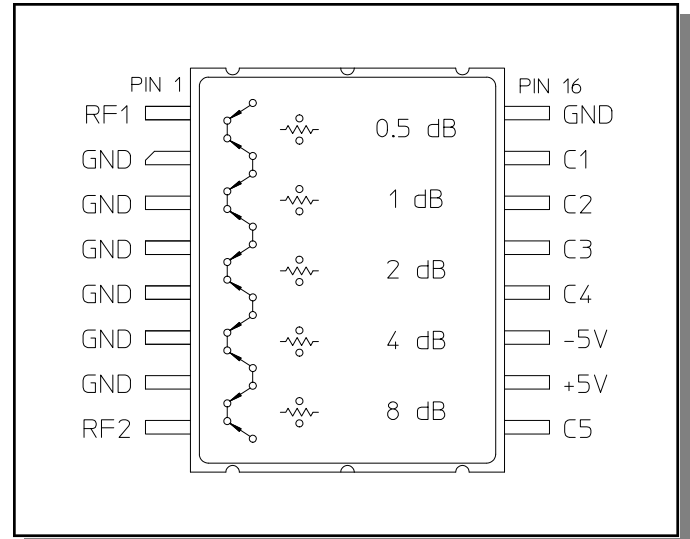

Pin Configuration ¹

Pin No.	Function	Pin No.	Function
1	RF1	9	C5
2	GND	10	+5V
3	GND	11	-5V
4	GND	12	C4
5	GND	13	C3
6	GND	14	C2
7	GND	15	C1
8	RF2	16	GND

1. The metal bottom of the case must be connected to RF and DC ground.

* Restrictions on Hazardous Substances, European Union Directive 2002/95/EC.

Constant Phase Digital Attenuator 15.5 dB, 5-Bit, TTL Driver, DC-3.0 GHz

Rev. V1

Electrical Specifications: $T_A = 25^\circ\text{C}$, $Z_0 = 50\Omega$, $V_{CC} = +5.0\text{V}$, $V_{EE} = -5.0\text{V}$

Parameter	Test Conditions	Frequency	Units	Min	Typ	Max
Operating Power ²	—	—	dBm	—	—	+20
Reference Insertion Loss	—	DC - 1.0 GHz	dB	—	—	4.0
		DC - 2.0 GHz	dB	—	—	5.0
		DC - 3.0 GHz	dB	—	—	5.3
Attenuation Accuracy ³	Any Single Bit	DC - 3.0 GHz	± (0.2 + 2% of attenuation setting in dB) dB			
	Any Combination of Bits	DC - 3.0 GHz	± (0.2 + 2% of attenuation setting in dB) dB			
Phase Accuracy Relative to Reference Loss State	Any Single Bit	DC - 2.0 GHz	deg	± 3		
	Any Single Bit	2.0 - 3.0 GHz	deg	± 4		
	Any Combination of Bits	DC - 1.0 GHz	deg	± 3		
	Any Combination of Bits	1.0 - 2.0 GHz	deg	± 4		
	Any Combination of Bits	2.0 - 3.0 GHz	deg	± 7		
VSWR	—	DC - 3.0 GHz	Ratio	—	—	1.8:1
Switching Speed	Ton	1.3 V Cntl to 90% RF	ns	—	47	—
	Toff	1.3 V Cntl to 10% RF	ns	—	24	—
	Trise	10% RF to 90% RF	ns	—	23	—
	Tfall	90% RF to 10% RF	ns	—	13	—
	1 dB Compression ⁴	Reference State	0.05 GHz	dBm	—	>+26
Reference State		0.5 - 3.0 GHz	dBm	—	>+26	—
Input IP3	For two-tone Input Power up to +5 dBm	0.05 GHz	dBm	—	+43	—
		0.5 - 3.0 GHz	dBm	—	+40	—
Input IP2	For two-tone Input Power up to +5 dBm	0.05 GHz	dBm	—	+50	—
		0.5 - 3.0 GHz	dBm	—	+72	—
Vcc	—	—	V	4.5	5.0	5.5
Vee	—	—	V	-8.0	-5.0	-4.5
VIL	LOW-level input voltage	—	V	0.0	0.0	0.8
		—	V	2.0	5.0	5.0
VIN	HIGH-level input voltage	—	V	0.0	0.0	0.8
		—	V	2.0	5.0	5.0
Iin (Input Leakage Current)	Vin = VCC or GND	—	uA	-1	—	1
Icc (Quiescent Supply Current)	Vcntrl = VCC or GND	—	uA	—	250	400
ΔIcc (Additional Supply Current Per TTL Input Pin)	VCC = Max Vcntrl = VCC - 2.1 V	—	mA	—	—	1.5
Iee	VEE min to max Vin = VIL or VIH	—	mA	-1.0	-0.2	—
Thermal Resistance θjc	—	—	°C/W	—	50	—

- Maximum input power is specified with power applied to RF1. If power is applied to RF2, then maximum operating power is +16 dBm.
- This attenuator is guaranteed monotonic.
- 1 dB Compression was measured up to +26 dBm, which is the absolute maximum rating for this device.

Absolute Maximum Ratings ^{5,6}

Parameter	Absolute Maximum
Max Input Power ⁷ DC - 3.0 GHz	+26 dBm
V _{CC}	-0.5V ≤ V _{CC} ≤ +7.0V
V _{EE}	-8.5V ≤ V _{EE} ≤ +0.5V
V _{CC} - V _{EE}	-0.5V ≤ V _{CC} - V _{EE} ≤ 14.5V
V _{in} ⁸	-0.5V ≤ V _{in} ≤ V _{CC} + 0.5V
Operating Temperature	-55°C to +125°C
Storage Temperature	-65°C to +150°C

- Exceeding any one or combination of these limits may cause permanent damage to this device.
- M/A-COM does not recommend sustained operation near these survivability limits.
- Maximum input power is specified with power applied to RF1. If power is applied to RF2, then maximum input power is +22 dBm.
- Standard CMOS TTL interface, latch-up will occur if logic signal is applied prior to power supply.

Recommended PCB Configuration

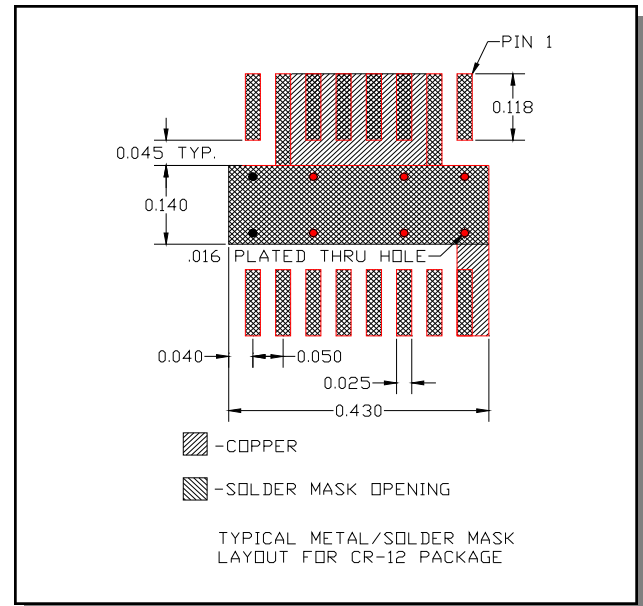

Handling Procedures

Please observe the following precautions to avoid damage:

Static Sensitivity

Gallium Arsenide Integrated Circuits are sensitive to electrostatic discharge (ESD) and can be damaged by static electricity. Proper ESD control techniques should be used when handling these devices.

Truth Table (Digital Attenuator)

Control Inputs					Attenuation
C5	C4	C3	C2	C1	
0	0	0	0	0	Reference
0	0	0	0	1	0.5 dB
0	0	0	1	0	1 dB
0	0	1	0	0	2 dB
0	1	0	0	0	4 dB
1	0	0	0	0	8 dB
1	1	1	1	1	31 dB

0 = TTL Low; 1 = TTL High

Typical Performance Curves

Reference Loss vs. Frequency

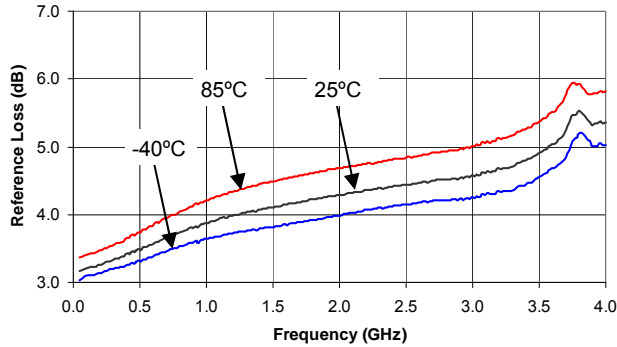

Attenuation - 0.5 dB Bit vs. Frequency

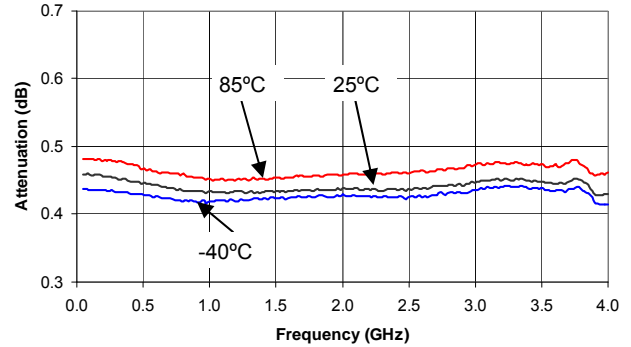

Attenuation - 1 dB Bit vs. Frequency

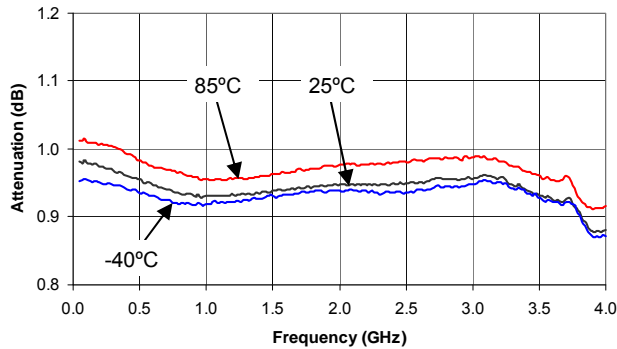

Attenuation - 2 dB Bit vs. Frequency

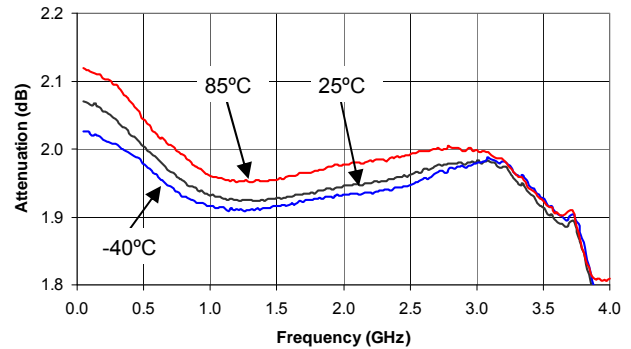

Typical Performance Curves

Attenuation - 4 dB Bit vs. Frequency

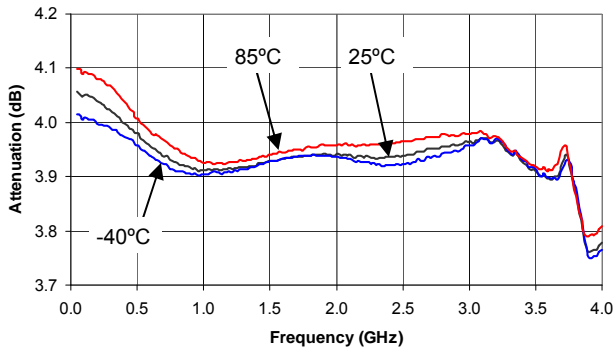

Attenuation - 8 dB Bit vs. Frequency

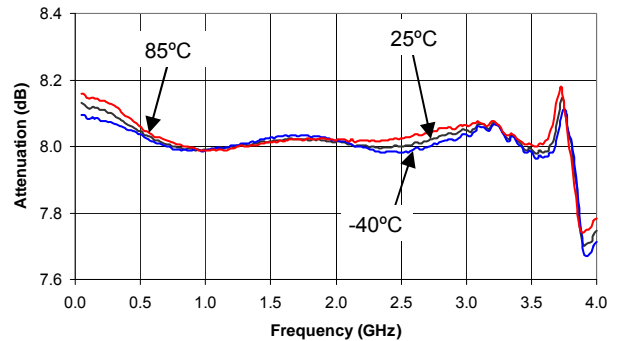

Attenuation - 15.5 dB Attenuation vs. Frequency

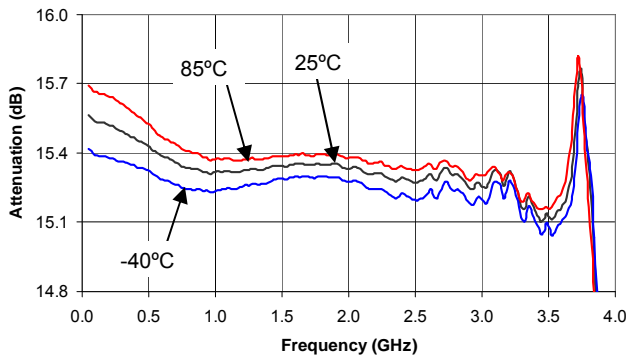

Phase - 0.5 dB Bit vs. Frequency Relative to Reference Loss State

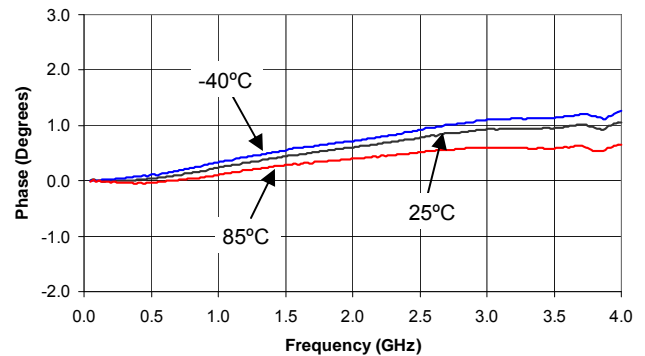

Phase - 1 dB Bit vs. Frequency Relative to Reference Loss State

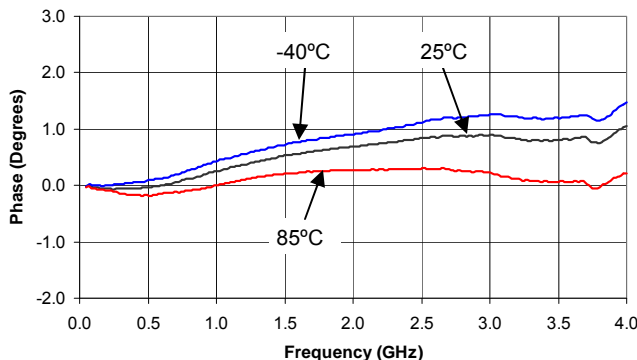

Phase - 2 dB Bit vs. Frequency Relative to Reference Loss State

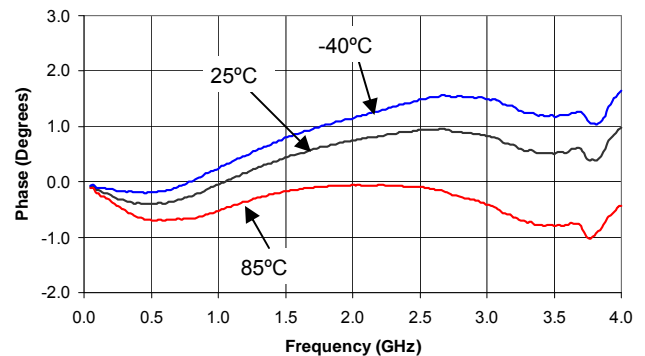

Typical Performance Curves

**Phase - 4 dB Bit vs. Frequency
Relative to Reference Loss State**

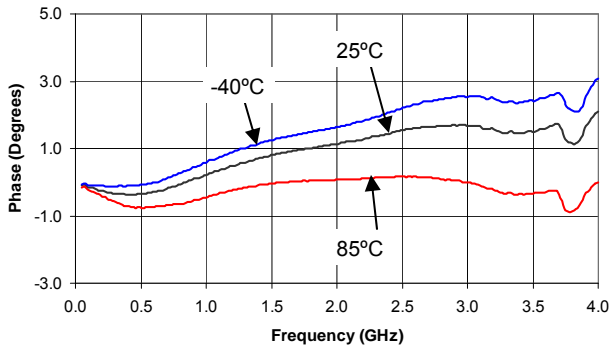

**Phase - 8 dB Bit vs. Frequency
Relative to Reference Loss State**

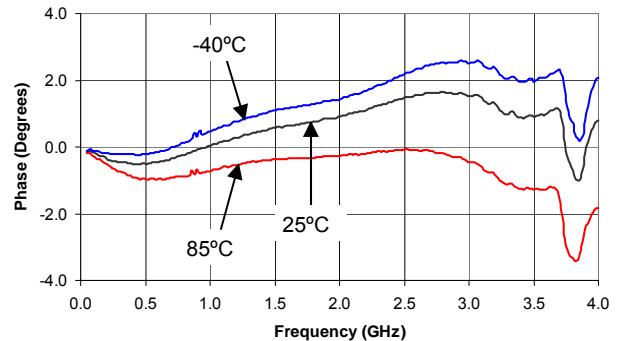

**Phase - 15.5 dB Attenuation vs. Frequency
Relative to Reference Loss State**

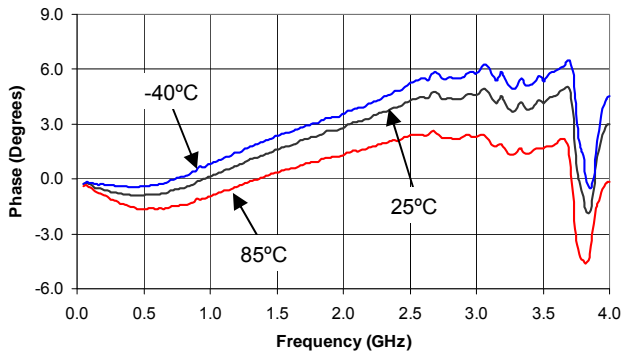

VSWR - Reference Loss State vs. Frequency

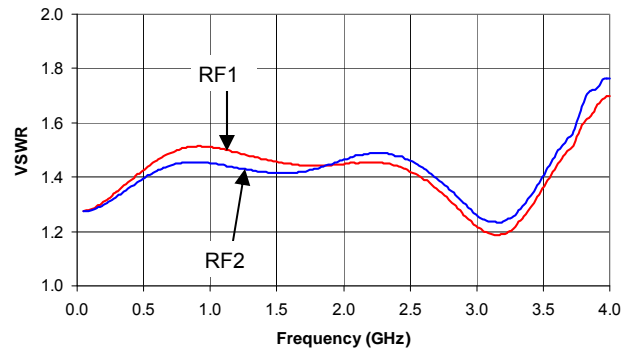

VSWR - 0.5 dB Bit vs. Frequency

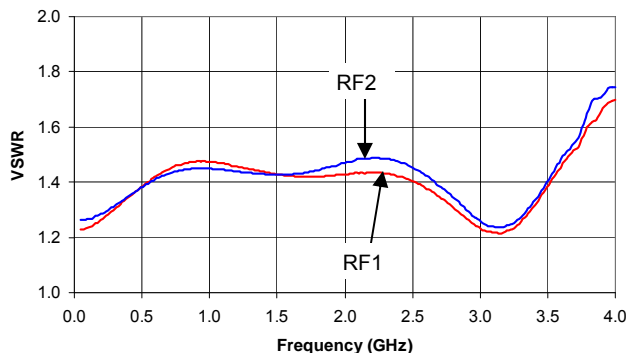

VSWR - 1 dB Bit vs. Frequency

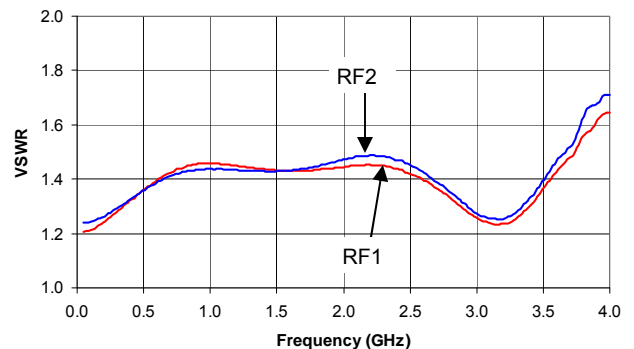

Typical Performance Curves

VSWR - 2 dB Bit vs. Frequency

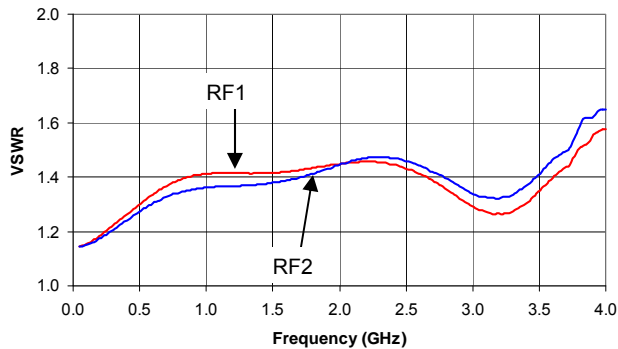

VSWR - 4 dB Bit vs. Frequency

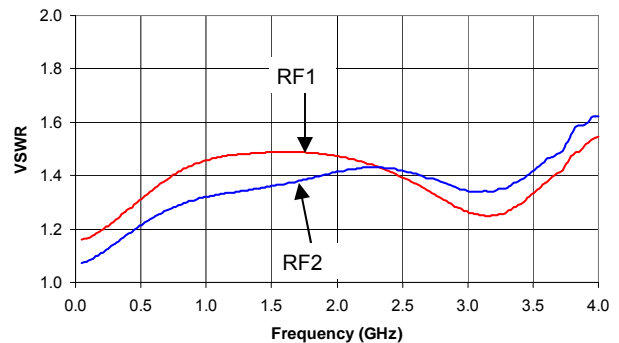

VSWR - 8 dB Bit vs. Frequency

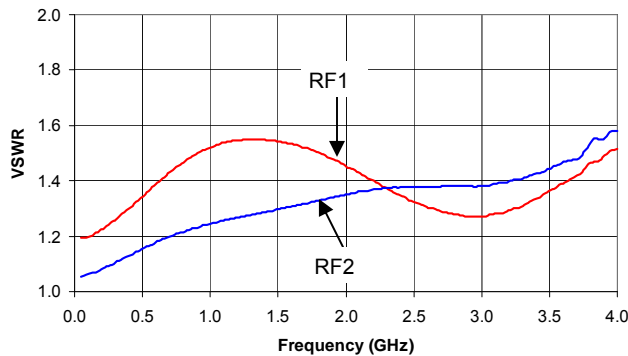

VSWR - 15.5 dB Attenuation vs. Frequency

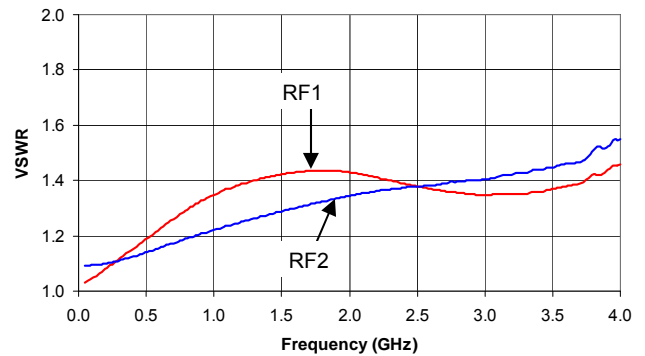

Typical Input IP2 and IP3 at Room Temperature⁹

Attenuation	IP2			IP3			Units
	50 MHz	500 MHz	2 GHz	50 MHz	500 MHz	2 GHz	
Reference State	50	72	73	43	40	44	dBm
0.5 dB	51	73	74	43	41	44	dBm
1 dB	51	73	75	43	41	44	dBm
2 dB	51	73	74	43	41	45	dBm
4 dB	51	73	74	43	41	45	dBm
8 dB	50	71	75	41	43	41	dBm
15.5 dB	53	74	79	43	42	44	dBm

9. IP2 and IP3 are measured with two-tone inputs F1 and F2 up to +5 dBm with 1 MHz spacing.

Lead-Free, CR-12 Ceramic Package[†]

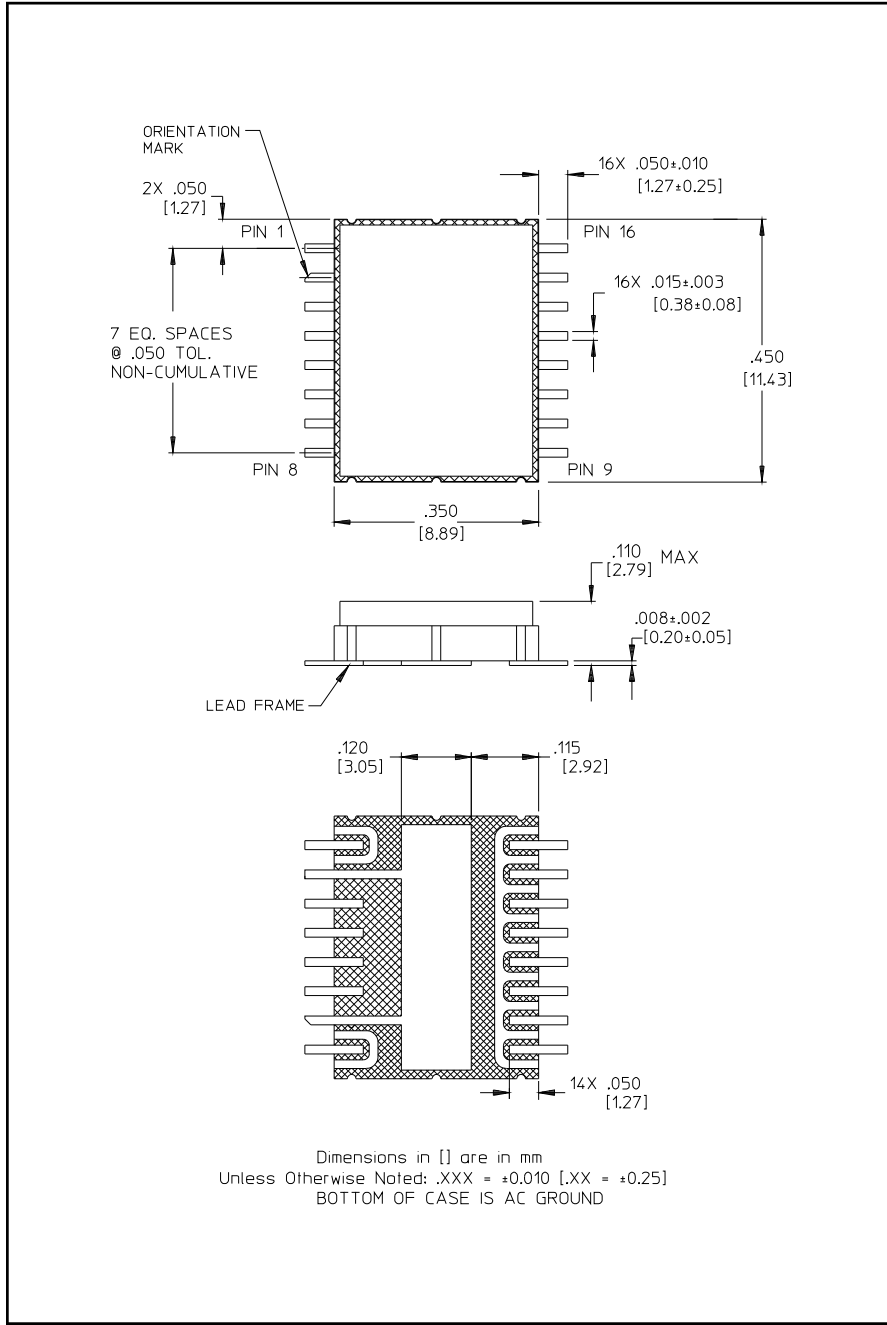

[†] Reference Application Note M538 for lead-free solder reflow recommendations.